

# MODERN WIRELESS

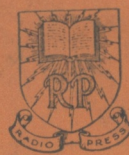

March

1/6

Vol. V. No. 6.

Edited by JOHN SCOTT-TAGGART, F.Inst.P., A.M.I.E.E.

March, 1926.

## *The* MELODY THREE

*By*  
PERCY W. HARRIS,  
M.I.R.E.

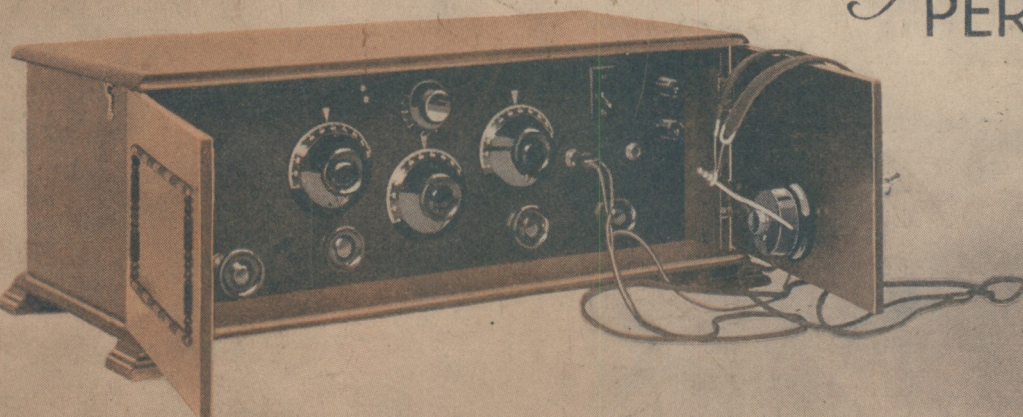

SPRING  
DOUBLE  
NUMBER

1/6



**HOW TO MAKE :** THE MELODY THREE. *By Percy W. Harris, M.I.R.E.*  
A SEVEN-VALVE SUPERHETERODYNE RECEIVER. *By C. P. Allinson.*  
THE NEUTROPHASE FOUR. *By J. H. Reyner, B.Sc. (Hons.), D.I.C., A.M.I.E.E.*  
A RECEIVER WITH TWO VALVES AND A CRYSTAL. *By E. J. Marriott.*  
A TWO-VALVE L.F. AMPLIFIER. *By G. P. Kendall, B.Sc.*  
A SET FOR VALVE RECTIFICATION EXPERIMENTS. *By A. V. D. Hort, B.A.*  
A CRYSTAL SET FOR 5 XX. *By Stanley G. Rattee, M.I.R.E.*  
**SOME NEUTRODYNE PROBLEMS.** *By the Staff of the Radio Press Laboratories.*  
**INTERFERENCE IN SUPERHETERODYNE RECEPTION.** *By H. L. Crowther, M.Sc.*

# BETTER THAN THREE



## A new general purpose Valve with the wonderful "N" filament

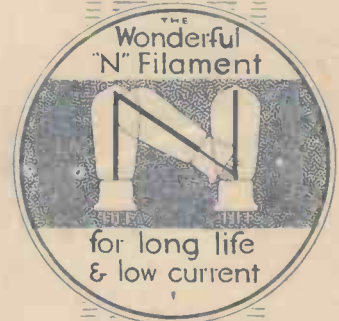

YOU can now have the advantages of the unique "N" filament for every valve in your receiver!

### The New P.M.3

1. Better than three "R" type valves because the ample proportions of the "N" filament are equivalent to three ordinary filaments.
2. Requires ONLY ONE-TENTH AMPERE filament current. A saving of over 85% of your accumulator energy giving each charge SEVEN TIMES THE LIFE.
3. Is so economical of heating power that no sign of glow can be discerned.
4. Will operate from either dry cells or accumulator. From 3 to 4 Volts may be used with perfect safety.
5. Free from all microphonic disturbances.

### The P.M.3 . . . . 16/6

Suitable for all stages of amplification in any circuit.

THE IDEAL COMBINATION for any receiver — P.M.3. valves followed by a P.M.4. for POWER AMPLIFICATION with loud speakers.

The Finest Loud Speaker Valve, the P.M.4. . . . . 22/6

GET ONE FROM YOUR RADIO DEALER.



# Mullard

## THE · MASTER · VALVE

ADVT. THE MULLARD WIRELESS SERVICE CO., LTD., BALHAM, LONDON, S.W.12.



# MODERN WIRELESS

Vol. V. No. 6.

## Contents

	PAGE
News of the Month ... ..	675
The Melody Three. By PERCY W. HARRIS, M.I.R.E. ... ..	676
In Passing ... ..	681
Some Interference Problems in Supersonic Heterodyne Reception. By Capt. H. L. CROWTHER, M.Sc. ... ..	684
The Neutrophase Four. By J. H. REYNER, B.Sc. (Hons.), A.C.G.I., D.I.C., A.M.I.E.E. ... ..	687
Removing a Misunderstanding ... ..	693
The Hilversum Broadcasting Station. By Capt. L. F. PLUGGE, B.Sc., F.R.A.E.S., F.R.Met.S. ... ..	695
Developments in Neutrodyne Reception. By THE STAFF OF THE RADIO PRESS LABORATORIES ... ..	698
A Seven-Valve Superheterodyne Receiver. By C. P. ALLINSON, 6YF ... ..	701
The Post Office and Interference. By Major A. G. LEE, M.C., B.Sc., M.I.E.E. ... ..	708
Laying Out Your Receiving Set. By A. JOHNSON-RANDALL ... ..	711
Radio in Other Lands. ... ..	714
Working with Two Valves and a Crystal. By E. J. MARRIOTT ... ..	715
The Era of Low Loss. By H. J. BARTON-CHAPPLE, Wh.Sch., B.Sc. (Hons.), A.C.G.I., D.I.C., A.M.I.E.E. ... ..	719
Regular Programmes from American Broadcasting Stations ... ..	722
A Set for Valve Rectification Experiments. By A. V. D. HORT, B.A. ... ..	725
Have You Tried to Use a Frame Aerial? By J. H. REYNER, B.Sc. (Hons.), A.C.G.I., D.I.C., A.M.I.E.E. ... ..	729
The Transatlantic Tests ... ..	732
The Curvature of Valve Characteristics. By Major JAMES ROBINSON, D.Sc., Ph.D., F.Inst.P. ... ..	733
Are You Getting the Best from 5XX? By STANLEY G. RATTEE, M.I.R.E. ... ..	736
The Importance of Valve Selection and the Effect on Selectivity. By THE STAFF OF THE RADIO PRESS LABORATORIES ... ..	739
Measurements on Your Receiver. By D. J. S. HARTT, B.Sc. ... ..	742
Which is the Best Aerial Circuit? By G. P. KENDALL, B.Sc. ... ..	748
Crystal Circuits in Theory and Practice. By THE STAFF OF THE RADIO PRESS LABORATORIES ... ..	760
Do You Want More Volume? By G. P. Kendall, B.Sc. ... ..	767
Regular Programmes from Continental Broadcasting Stations ... ..	775
Simple Theory Put Into Practice. By C. P. ALLINSON ... ..	781
Problems in Loud-Speaker Design ... ..	785
A Few Applications of the Thermionic Valve ... ..	788
How to Make a Useful Resistance Box ... ..	795
Tested by Ourselves ... ..	801

Edited by  
JOHN SCOTT-TAGGART, F.Inst.P., A.M.I.E.E.

**Radio Press, Ltd.,**

Publishers of "Wireless Weekly,"  
"The Wireless Constructor,"  
"Wireless," and "The Wireless Dealer."

Bush House, Strand, W.C.2

Telephone: City 9911.

All correspondence relating to contributions is to be addressed to the Editor of "Modern Wireless."

Nothing contained herein is to be regarded as permission or encouragement to infringe any patent rights.



# What do you most want when you buy Condensers?

**O**NLY the "Polar" Cam-Vernier Variable Condenser can give you all the qualities you look for. The extreme delicacy of control, selectivity and noiseless operation made possible by the "Polar" Condenser infinitely improve the tuning arrangements of a circuit.

The efficient design and mechanical excellence of the "Polar" Condenser not only adds to the possibilities of the circuit, but the new large Dial illustrated below is also a worthy finish to the appearance of your Set.

All "Polar" Condensers carry an unconditional guarantee against original defects and against breakdown in ordinary use over a period of 12 months.

If you would be sure of the greatest help in tuning—specify "POLAR."

**Square Law?** The "Polar" Cam-Vernier Condenser gives a true square-law characteristic when actually in your Set; the vanes are specially shaped to compensate for capacity of the circuit in shunt with the instrument. Only the "Polar" Condenser will give you square-law reading *under working conditions*.

**Vernier Control?** The Patent Cam-Vernier device is embodied in the "Polar" Condenser, allowing a reduction of 10 to 1 over any portion of the dial; and the vernier reading is registered directly on the scale. The smoothly-working Cam-Vernier affords great selectivity and makes the tuning-in of distant transmissions a real pleasure. Gears are entirely avoided, so that the "Polar" Condenser gives you a precise vernier control *with complete absence of backlash*.

**Low Loss?** The moving plates of the "Polar" Condenser are joined to the terminal by a PIGTAIL CONNECTION; and this, combined with endplates of best quality ebonite, results in extremely low dielectric loss. The vanes are very robust, well-spaced and carefully balanced. All danger of shorting is eliminated.

**Smooth, Silent Operation?** It is a delight to handle a set equipped with "Polar" Condensers! Motion is smooth and precise even with coarse tuning, while the Cam-Vernier device, operated by the same knob, gives infinite delicacy of control. The high instrument-finish of "Polar" Condenser results in absolute silence in operation—an essential quality for successful long-distance reception.

**Modest Cost?** For all its excellence, the "Polar" Cam-Vernier Condenser is not an expensive instrument. Its actual cost is below that of many Condensers now on the market, and it will certainly give many times its value in honest service. Available in 3 capacities:—

.001 .. 14/- .0005 .. 13/- .0003 .. 12/- Including new large dial as illustration.

## BALL BEARINGS

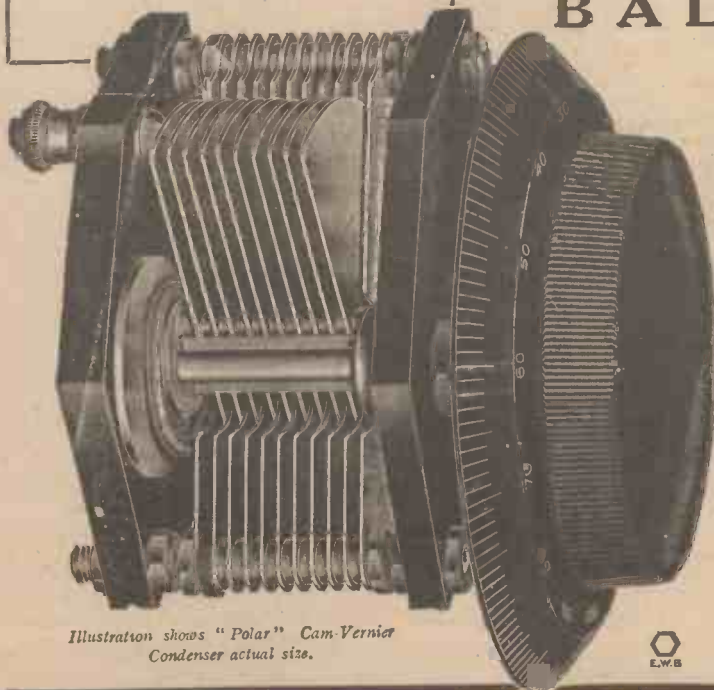

Illustration shows "Polar" Cam-Vernier Condenser actual size.



Obtainable from all reputable Radio Dealers.

It should be noted that the scale reading of the Dial covers from 26 to 100 degrees, recognising that no tuning system can have a zero capacity. The wavelength range is always proportionate to 26-100, whatever inductance value is in circuit.

Write to-day for the "Polar" Condenser Booklet. This contains information on Condensers which no amateur should be without, and is sent gratis on receipt of a postcard to the manufacturers:—

Wireless Operators still Wanted

There are now vacancies on our Sea-going Staff for Junior Wireless Operators, trained on our apparatus. Youths of good education, preferably between 17 and 25 years of age, wishing to enter the Wireless Profession, should communicate with the Managing Director, London Radio College, 82-83, High Street, Brentford, Middlesex, who will be pleased to furnish particulars of the training course necessary to qualify for our Service.

**Radio Communication Co. Ltd.**  
34-35, Norfolk Street, Strand,  
London, W.C.2.



**T**HE wireless enthusiast is always keen to carry out experiments for himself, and the fostering of this spirit is to be encouraged wherever possible. Home constructors are in the happy position of being able to keep all their apparatus up to date, and the many features in this month's issue of MODERN WIRELESS give full information of a practical nature which will render great assistance in this direction.

**Incorporating Modern Improvements**

The receiving set featured on the cover this month, "The Melody Three," has been designed by Mr. Percy W. Harris, and incorporates a number of modern improvements. Good loud-speaker strength is obtainable from many Continental stations, together with several main B.B.C. stations, and the receiver should achieve great popularity. A seven-valve superhet., by Mr. C. P. Allinson, will meet the demands of those of our readers who desire distant reception with the minimum of controls, coupled with great selectivity. In conjunction with this constructional article should be read "Some Interference Problems in Supersonic Heterodyne Reception," by Capt. H. L. Crowther, who points out the essential features to be observed for the successful operation of superheterodynes.



The Melody Three

**True Neutrodyning**

"The Neutrophase Four," by Mr. J. H. Reyner, is a step towards the practical application of the sound theoretical ideas in neutrodyning schemes recently discussed in the columns of this journal, while Mr. G. P. Kendall has designed a two-valve power amplifier which will prove valuable on the experimenter's bench. The purity of the signals obtained with crystal rectifiers have been borne

in mind by Mr. E. J. Marriott, and the embodiment of a crystal with an H.F. and an L.F. amplifier has resulted in a receiver giving good loud-speaker strength up to 15 miles from the local station. The experimenter can satisfy himself as to whether anode current rectification is superior to cumulative grid rectification, or *vice versa*, by constructing the single-valve set described by Mr. A. V. D. Hort, and the constructor who desires Daventry to be his main station, with the local station as a secondary consideration, is referred to the details given by Mr. Stanley G. Rattee in "Are You Getting the Best From 5XX?"

**Interference**

The usual regular features maintain their high standard, and in view of the comments frequently made concerning the interference produced by the high-power wireless stations of the Post Office, the article by Major A. G. Lee, Chief of the Post Office Radio Section, is most opportune and enables that department to state its side of the question.

The recent activities of the Radio Press Laboratories are reflected in the useful information contained in Developments in Neutrodyne Reception, the Importance of Valve Selection and the Effect on Selectivity and Crystal Circuits in Theory and Practice.

**Other Features**

Major James Robinson deals with the Curvature of Valve Characteristics from an interesting standpoint, while the Low-Loss Era is critically examined by Mr. H. J. Barton-Chapple. The essentials to be borne in mind when laying out a receiving set are made clear by Mr. A. Johnson-Randall, and a host of other special articles of interest go to make this Spring Double Number value for money in every sense of the word.

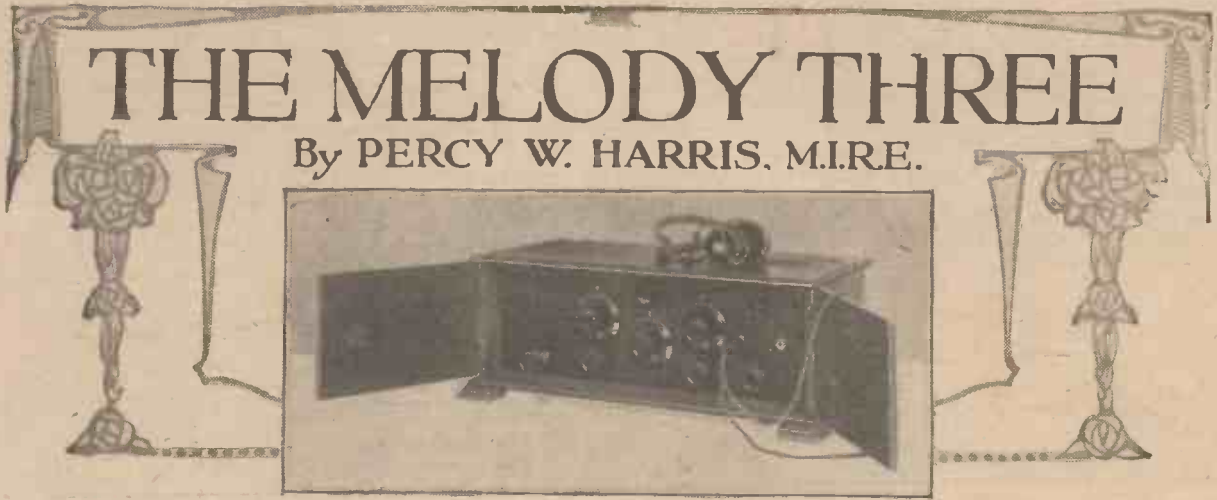

*Many distinctive features are embodied in this receiver which should prove popular with even the unskilled members of the family.*

**T**HE Melody Three is an attempt to produce a cabinet receiver of pleasing appearance, giving really good loud-speaker reproduction of several stations, with the minimum number of valves. It possesses a higher selectivity than is customary with a receiver using only one stage of high-frequency, a detector and one note magnifier, and incorporates a number of other modern improvements, such as neutralised self-oscillation, to obtain freedom from radiation.

**A Different Reaction Control**

While plug-in coils are used, thus obviating the necessity of obtaining special coils (other than one tapped coil for the first grid circuit), these coils are inside the receiver,

and do not provide unsightly projections. Furthermore, the aerial circuit is loose-coupled to the first grid circuit, and the reaction control is different from that previously described in any Radio Press constructional set. This method enables variable magnetic reaction to be obtained, although the reaction coil is fixed in relation to the anode coil.

**Simplification of Layout**

The arrangement of the parts enables a symmetrical layout of the panel to be obtained, and a jack system is introduced so that economy of valve current can be effected when it is desired to listen on telephones, by plugging into the first jack.

Simplification of layout has been obtained after some thought, and the actual work of construction will not occupy a great deal of time, as practically all the parts mounted on the front panel are of the "one-hole fixing" variety.

**Components**

The following components are those used, and while the makers are indicated in accordance with our usual policy, it must not be imagined that many other components advertised in these pages will not be equally suitable. Certain parts, however, have a definite relation to one another, and should not be changed without thought. For example, the particular variable condensers used are very compact,

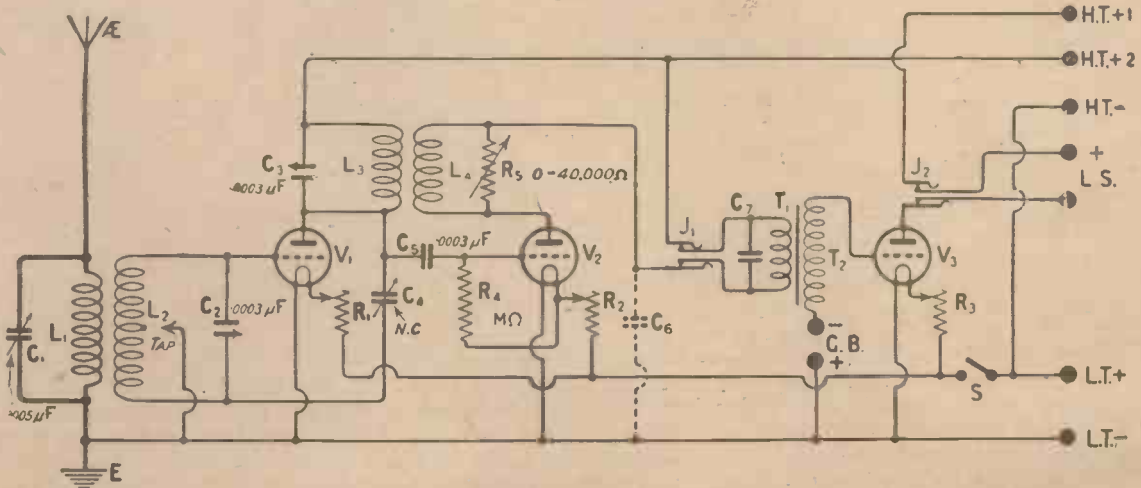

Fig. 1.—Variable magnetic reaction can be obtained although the reaction coil is fixed in relation to the anode coil.

and the substitution of some other makes which would take more space might upset the whole layout and disposition of parts.

One panel measuring 21 ins. × 7 ins. × ¼ in. (Pilot).

Four indicating terminals, aerial and earth, loud-speaker positive and loud-speaker negative (Belling and Lee, Ltd.).

One No. 1 Terminal strip (Magnum).

One two-coil holder (L. & P.).

One variable condenser .0003 μF (Bowyer-Lowe Popular).

Two variable condensers .0003 μF (Bowyer-Lowe Popular).

Three filament resistances (C.A.V.). (These should be chosen to suit the valves you use. The particular pattern has interchangeable bobbins, so that if at any time you desire to change the type of valve you need only change the bobbin.)

One on and off switch (Rothermel Radio Corporation).

Two double circuit jacks (Igranic). Plug for same (Igranic).

One Polar Neutrodyne condenser with bracket for mounting behind panel. (This particular form is now available from the makers who have made it up at my suggestion.)

Two fixed coil sockets for base-board mounting.

One combined .0002 μF condenser and 2 megohm grid leak (Watmel).

Three valve holders (Lotus).

One variable resistance 0 to 40,000 ohms (Marconiphone).

One L.F. transformer (A.F.3)

the negative L.T. lead which runs along the back of the base board.

Glazite wire for wiring up.

One cabinet ("Harmony Four" size), (Caxton Wood Turnery Co.).

**Pay Attention to Details**

Follow the layout of the receiver carefully, Fig. 2 giving details of the panel, or you will find diffi-

**Centre-Tapped Coils**

When building the receiver it is as well to keep handy the actual coils you will use. For the aerial coil, the anode coil, and the reaction coil respectively, any of the well-known makes will do, provided suitable sizes are chosen. (You will read more of this later in the article.)

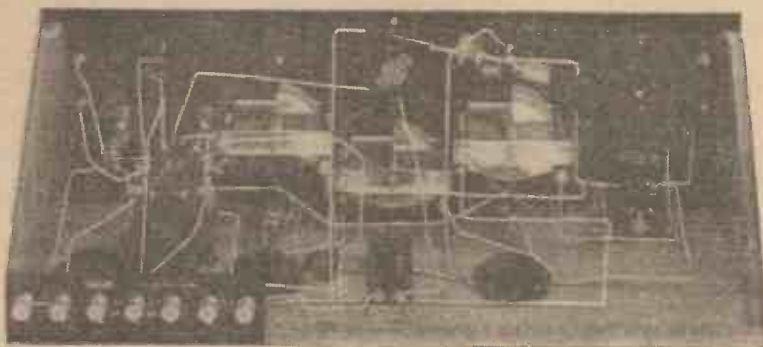

Carefully note the positions of the variable condensers.

culty in fitting the parts, and read very carefully the instructions given in the L. & P. coil-holder box. The Neutrodyne condenser needs mounting with care in order to avoid its moving parts fouling, on the one hand, the coil, and the other hand, the variable resistance used for controlling reaction.

The particular cabinet used with

For the first grid coil, however, you will need a centre-tapped coil, and such coils are obtainable from Messrs. Gambrell, and more recently from Messrs. Lissen. If you are using the Gambrell, insert it in the fixed socket of the coil-holder, and make sure that it clears the wiring when you are wiring up.

You will notice there is one

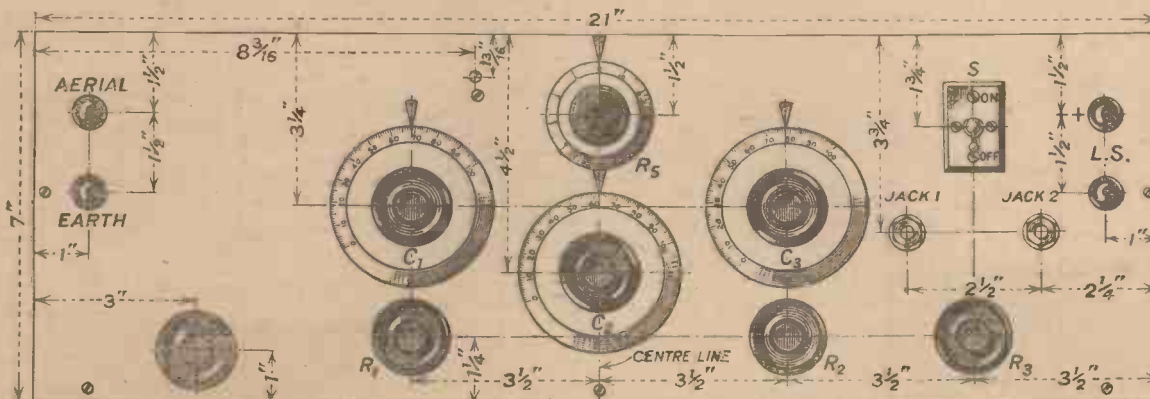

Fig. 2.—Panel details are given in this figure, while, if desired, blueprint No. 152a can be obtained for 1s. 6d., post free.

(Ferranti). This particular transformer has a shunting condenser built into it. If you use a different type of transformer which has no condenser built in it, then shunt the condenser across the points shown in the theoretical diagram Fig. 1. In actual wiring up, this condenser would come between the left-hand terminal of the back fixed coil socket (looking from the front) and

this receiver has doors at the front and the panel itself is set back from the front of the cabinet 2 or 3 ins. This enables one to get at the coil-holder for changing coils quite conveniently when the lid is lifted, as the coils themselves then come immediately under the lid, and not under any projecting portion of the box which would make it difficult to get at them.

flexible lead from the first variable condenser to the centre tapping on the coil. This should be of single india-rubber covered flex, and you will find it convenient to solder on the end of the flex a spade terminal which can be screwed under the terminal of the tapped coil. This saves time when changing coils. Fig. 3 makes clear the wiring of the receiver.

**Simple to Handle**

The operation of this receiver and its preliminary adjustments are probably different from those to which you are accustomed. Do not be surprised if the preliminary adjustments take you a little time. Once you have made these adjust-

ments, the tuning is difficult. In practice the tuning is first of all carried out on the second and third condensers, with final adjustment on the first and the coupling.

**Adjustments**

When you have finished wiring

ness of the filament can be varied by the filament resistance.

**Valves**

Before going further it is as well to explain the position with regard to valves in this set. In view of a special form of resistance control of reaction it is advisable to use for the detector valve a D.E.5B., D.F.A4, or equivalent. The first valve is preferably a 0.25 amp. small-power valve, although quite good results are obtainable with the ordinary high-frequency bright emitter valve. The last valve can be any valve suitable for low-frequency amplification, and I have used many kinds with equal success. If you are to get the best out of this instrument I would strongly recommend you to use the special type mentioned as the detector, although if you use the ordinary bright emitter valves you will still get results very much better than those given by the average 3-valve receiver, using one H.F. stage and one note magnifier. The reaction control, however, will not be so efficient as with the special valves.

**Coils**

For the aerial coil use a No. 25, 35 or 50 (or their equivalents in other makes) according to the particular aerial you are using, and the wavelength. Normally, you will keep the coupling fairly loose, but

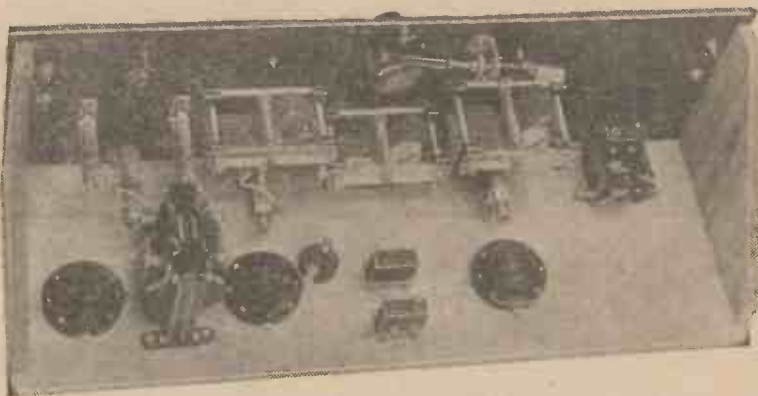

Before wiring up the receiver see that all the components are mounted as shown in this photograph.

ments they will remain constant unless you should change valves and coils. When the adjustments have been made the receiver is remarkably simple to handle, and you should not be misled by the fact that there are three condensers into thinking that the operation is

up, connect the L.T. battery, and then, by placing a valve in one socket after another, test if your filament connections are correct. This you will find by seeing whether the valves light up, whether the "off" and "on" switch operates correctly, and whether the bright-

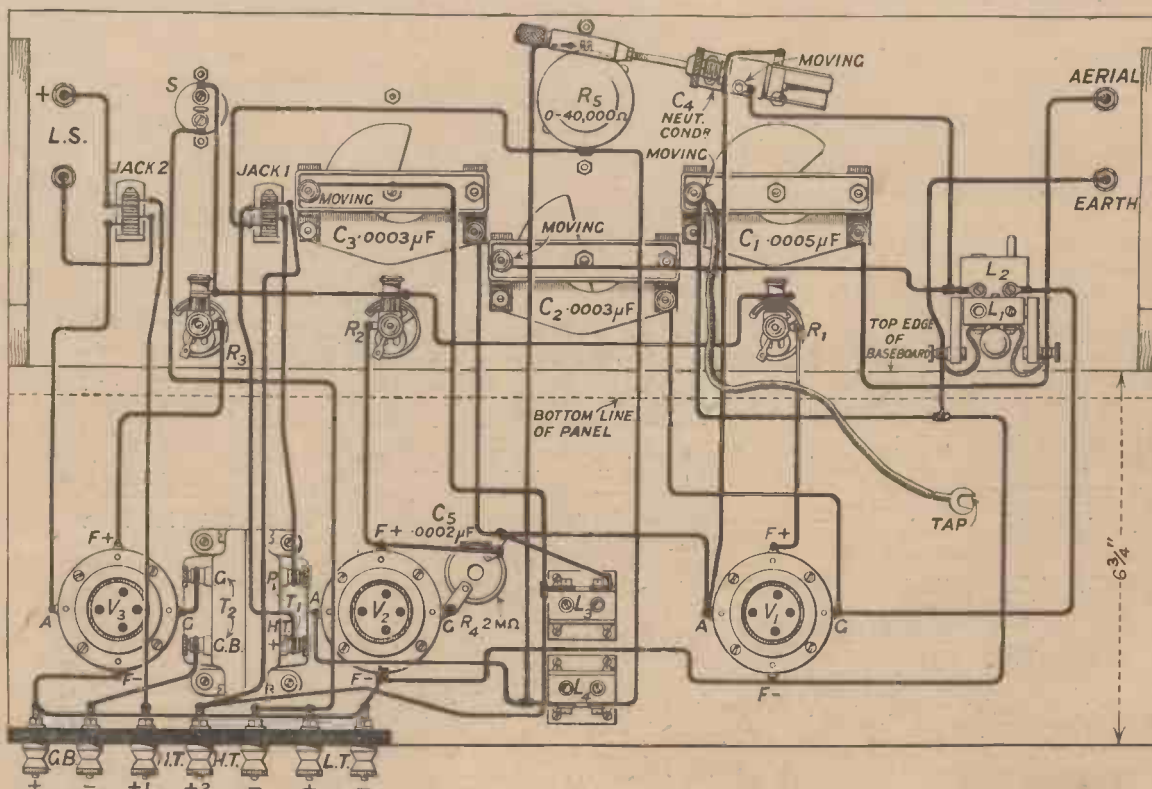

Fig. 3.—A large blueprint, No. 152b, of this wiring diagram is available for 1s. 6d., post free.



the best value of this can soon be found by experiment. For the first grid coil you must, as mentioned, use a centre-tapped coil, for which I would suggest either a centre-tapped C coil of Gambrell's or a centre-tapped 60 of Lissen's for the lower broadcast band. For 5XX you will need a centre-tapped F or 250. for the anode coil a

telephones in the first jack, place a suitable tapped coil in the fixed socket of the two-coil holder, and do not trouble to put any coil in the aerial socket. Place a 60 or 75 in the anode socket and a short circuit in the reaction socket. Light your valves in the usual way. Next, ignoring the first dial, which we shall not be operating at

tion when the two condensers mentioned are varied, recheck this fact by trying the condensers at the bottom end of the scale; possibly there may be slight variation of the neutralising condenser necessary to check any oscillations at the bottom end of the scale. Now lock the neutrodyne condenser and insert in the reaction coil socket a coil of about the same size as that used in the anode socket. Now vary the resistance above the central dial, and check again for oscillation in the receiver. You will soon find that this resistance gives a reaction control similar to that obtained by moving a reaction coil towards the anode coil. If no variation in resistance will bring the set into oscillation it may be necessary to reverse the connections to the reaction coil socket.

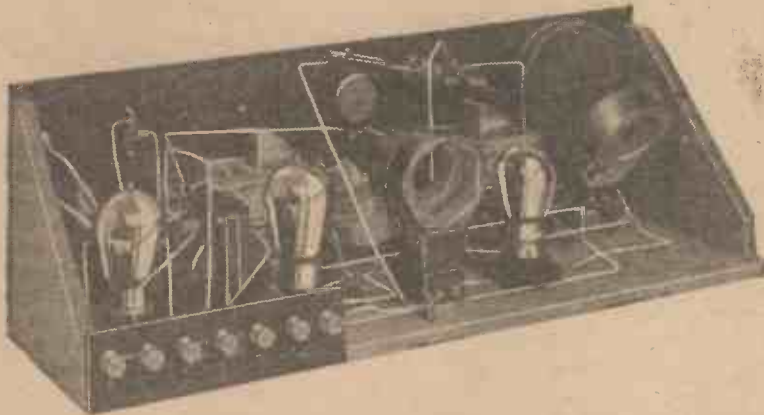

With the coils and valves inserted in position, this receiver is quite compact.

**Tuning Operations**

As soon as you have obtained the correct control of reaction insert a suitable coil in the aerial socket, connect up aerial and earth, and tune the receiver in the usual way. For preliminary tuning it is as well to have the coupling between the aerial coil and the tapped coil fairly tight. In these circumstances, you will find the tuning of the first dial very flat, and most of the searching for stations will be done on the second and third dials. When you have found the station slacken the coupling, retune on the first condenser, and bring your signals up to best strength by the resistance used for reaction control.

**Coils to Use**

In the aerial-coil socket you will need a coil suitable for the wavelength it is desired to receive when used in conjunction with your own aerial. Large aerials will require smaller coils than small aerials for the same wavelength. A 25, 35

60 or a 75 or a C of Gambrell's will serve, and a similar size of coil in the reaction socket. For Daventry two F coils or two 250 coils will be needed in the anode and reaction sockets.

**Preliminary Adjustments**

For preliminary adjustments do not trouble to connect aerial and earth, but connect your telephones and batteries. In passing I should mention that the second jack is so arranged that on withdrawing the telephone plug from the jack the loud-speaker is automatically switched on, and on inserting the telephones in this last jack the loud-speaker is cut off. Using

the moment, vary the second and third dials with the neutrodyne condenser placed for maximum capacity (plates close together) and you will find a point where self-oscillation of the receiver takes place. This is indicated by a rushing noise and a "plop" whenever the set goes in and out of oscillation. Unscrew the locking nut of the neutrodyne condenser and carefully vary the position in steps, at each step trying the condensers again to see whether oscillation takes place.

**No Oscillation**

When a point has been reached that shows that there is no oscilla-

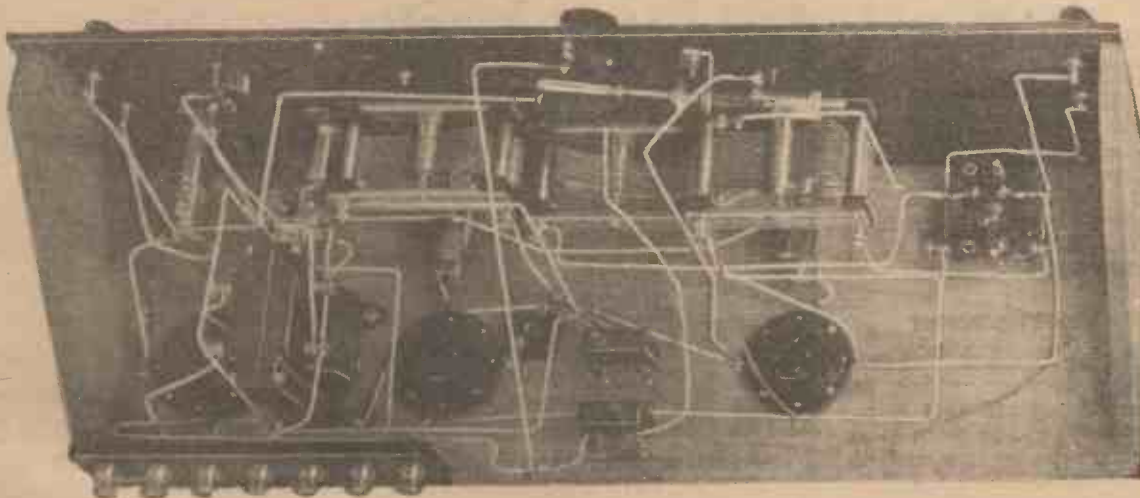

The wiring may be followed from this photograph.

and 50 or the equivalents of these coils in makes which are lettered instead of numbered, should enable you to cover the whole lower broadcast band. For 5XX and Radio Paris, you will need a No. 150 in the aerial socket.

**Results obtained with the Receiver**

On test this receiver was found to give full loud-speaker strength from a number of Continental stations, such as Hamburg, Toulouse, Madrid, etc., while several of the British stations gave good loud-speaker volume. The selectivity was found to be considerably higher than that obtainable with the conventional arrangement of H.F., detector and L.F. valves and tuned anode coupling, and 7 miles from 2LO Newcastle and a number of stations round the wavelength used by that station were received without the slightest interference from London. The receiver is particularly suitable

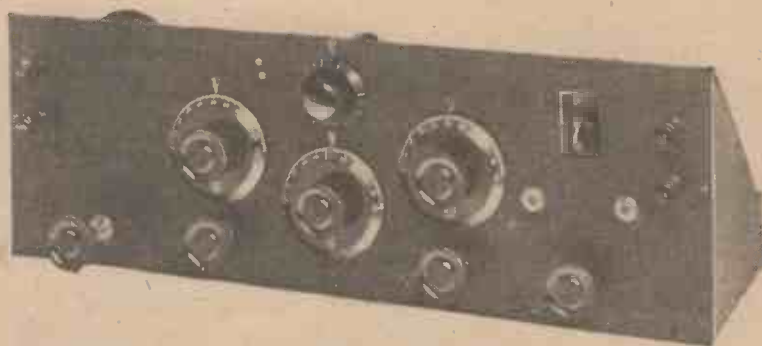

The panel arrangement has been planned with care.

for use with an indoor aerial. By plugging into the first jack and turning off the last valve excellent telephone strength was obtainable from dozens of stations all over Europe, the quality of reproduction on both two and three valves being up to a very high standard. The provision of the "on-and-off" switch enables the receiver

to be adjusted for the local station with the loud-speaker connected, and then turned on and off at will by any unskilled members of the family. The fact that the receiver is built into a cabinet with closed doors which need only be opened and the switch turned on to bring in the local station at full loud-speaker strength, is a useful feature.

*The Visit of the Press to the Radio Press Laboratories*

On Tuesday, February 9th, 1926, representatives of the leading London newspapers and Press agencies accepted the invitation of the Editor of *Wireless Weekly* to visit the Radio Press Laboratories at Elstree, in order to observe the tests on broadcast interference. The party included representatives of the *Daily Chronicle*, the *Daily Express*, the *Daily Mail*, the *Daily News*, the *Daily Telegraph*, the *Morning Post*, the Press Association, and the Central News.

**An Accurate Wavemeter**

Great interest was displayed by the visitors in the standard wavemeter, which is accurate to one part in 3,000, or, expressed in the jargon of a representative of one daily journal, wavelength differences as small as 4 inches can be detected.

**The Test Period**

During the test period a special receiver, shown on another page in this issue, was employed to listen in on the previously determined wavelengths of the B.B.C. stations, to find whether

stations were working on any of them.

**Interference**

Interference was observed on the wavelengths of Bournemouth, New-

castle, Glasgow and Belfast, but since many of the Continental stations shut down before the test period commenced, a certain amount of information was unavoidably not obtained.



A photograph taken during the tests at Elstree. Capt. H. L. Crowther is operating the wavemeter—the sloping panel instrument.

# IN PASSING



"SPRIGG," said Professor Goop, flinging his handkerchief into the fire and applying vigorously to his nose the large lump of coal that he had just removed from the scuttle with the tongs; "Sprigg is 'albst upod us. Do you dot feel the gedtle urge of it id your blood, Way-farer?" "Do I," I answered, "Certaidly dot. I feel it maidly id by dose." I went on to tell the Professor of the poet, Keating (or was it Keats? I am never quite sure) who once wrote:

"Oh, to be in England  
Now that spring is here!"

### Seeking Inspiration

I have always deduced from this sentence that Keats (or Keating) did not know when he was well off. The Professor and I, on the afternoon of which I am talking, were sitting in his study, whilst outside there raged the kind of gale that brings down the aerial put up when the new set was installed at Christmas time. And sometimes it rained, and sometimes it hailed, and sometimes it snowed, and sometimes it did all of these things at once. Like about 90 per cent. of the population of these islands, the Professor and I were engaged in nursing colds, though even the shattered condition of our health did not



... applying vigorously the large lump of coal.

prevent us from toiling as only he and I know how to toil. Our trouble for the moment was that we were completely bereft of an inspiration owing to the mind-deadening effects of our terrible colds. I know of no harder work than that involved in searching under difficulties for inspiration. I always do it lying back in a comfortable chair with my eyes closed. One is thus able to con-

centrate fully upon the matter in hand. I was awak . . . that is to say I was roused from my close concentration by hearing the sound of the Professor's voice once more. Having well rubbed into you that we both had colds, I shall forbear from now onwards from reproducing in print—you will notice that I do not say cold print—the accents due to our unfortunate malady.

### Considerations

"We are agreed," said the Professor, "that spring is approaching. Now what follows after spring?" "Autumn," I said, after a moment's thought; "the old records contain, I believe, accounts of another season which used to come in the middle of the year, but this has long ceased to exist. Somewhere about the end of June the chilly blasts of spring merge into the chillier blasts of autumn; after that comes winter, and then more spring." The Professor admitted that there was a great deal in what I said, but he told me that I was suffering from an excess of pessimism. The season known as summer was, he explained, still officially recognised, and even though there might be no rise in the temperature or improvement in the general state of the weather, the wireless man could always tell that the so-called summer had arrived owing to the unwelcome fact that it provided him with a considerable reduction in the hours of glorious darkness. "But," he went on, "both the spring and the summer have another drawback in addition to that of lengthened days and reduced nights. I need hardly ask you what that is." By the time that he got so far I had begun to concentrate again and it was only by prodding me violently in the ribs with the poker that he was able to capture my attention once more. Now if there is one thing that I do detest it is being prodded in the ribs. Though I am naturally one of the mildest of men, this kind of thing rouses me to instant action, no matter how deeply I may be concentrating at the time. I was so angry that had

not the Professor seized the tongs in the other hand and assumed a resolute attitude I should probably have slapped his hand and called him a naughty boy. I am a perfect fiend when my temper is stirred up. As it was, I merely sneezed three times with great emphasis and then asked him to tell me what the other disadvantage of the spring and summer was.

### Catechised

The worst of the Professor is that he can never come straight to the point. For some reason,



Prodding me violently in the ribs.

instead of giving a direct answer he always wants to ask you question after question with the idea that by replying to them you shall provide the answer to the original one. He asked me what was the greatest handicap imposed upon wireless by what the optimists call the warmer weather. He was quite angry when I said tennis, and his wrath grew as I suggested, turn by turn, birds' nesting, writing poetry and picnics. Nothing would convince him that I was really trying. After some little time he gave it up as hopeless and at my urgent request supplied the answer himself. According to him, and I am inclined to agree that he is right, the greatest bugbear to the wireless man during the middle period of the year is to be expressed in the one word "atmospherics." Having told me that, he started his questioning all over again. "Why," he asked, "are atmospherics worse in the summer time?" "Because," I replied, "people are then too lazy or too broke to go out and buy new high-tension batteries." He looked at me coldly and I tried again. "Because," I began; but he cut me short. He proceeded to give

me his own explanation of the prevalence of atmospherics in the season under consideration, whilst I settled down to concentrate upon his words. It is difficult to concentrate properly when your informer is armed with both the poker and the tongs and you must forgive me if I have left out anything that he said, or have misreported him in any way. So far as I can



A large number of sunshades and umbrellas.

make out, the idea is that at this time of year the heaviside layer becomes the lightside, and the sun spots that cause arctic weather at other times now give rise in some parts of the world to torrid heat and thunderstorms. Further, the atmosphere becomes ionised (or possibly it is de-ionised) and lots of other things happen. My own personal belief is that the high-tension battery dries up, but, of course, it would never do for me to obtrude my opinions when so great a man as Professor Goop is giving his to the world. Anyhow, the net result is the same. You hear crackles, fizzes and noises like the tearing of American cloth whenever you don the telephones or switch on the loud-speaker. Atmospherics, the Professor explained, are always at their worst when you try for distant stations. This is perfectly understandable, for no self-respecting man is ever without a good excuse when he fails to receive a long-range transmission.

**The Index**

The Professor's argument was that it is a recognised fact that atmospherics are at their worst during the lighter period of the year, and that it was up to him and me to produce some efficient device for eliminating them in order that reception might continue uninterrupted during the whole of the twelve months. On talking the matter over we decided that it would be as well to refer to the records of past years. The Professor carefully keeps all wireless articles that especially interest him, tearing them out of their parent periodicals and filing them on a system of his own which is supposed to enable them to be found at a moment's notice. Upon investigation I discovered

that neither the tearing out system nor the filing system was above reproach. Most of the pages were torn diagonally from the top right hand corner to the bottom left, so that much valuable matter was left to the imagination of the reader. But the worst of it was that the coming of spring had brought to the Professor not only the thoughts of atmospherics but also the actualities of spring-cleaning, with the result that his card index had become slightly disorganised. When I tell you that I looked naturally for "Atmospherics" under the A's, and found them under the X's, you will understand what I mean.

**Experiments**

After reading all that we could find upon the subject we began to feel that there appeared to be no possible way of eliminating atmospherics. On perusing able articles by such writers as Mr. G. P. Bendall, we discovered that when the voltage due to a healthy atmospheric is measured by means of the ordinary Moulmein Pagodameter—I think that is the name of the device—it is either very great

pherics and the other for receiving the desired signal. This would be all right if only the aerials would play the game. When Professor Goop and I tried the system out we found that both of them would insist on bringing in atmospherics, so that all we got was a double dose. After considerable thought, we hit upon another line of research which appeared at first to show no small amount of promise. If, we argued, atmospherics are largely weather effects, occurring more frequently in summer than in winter, then why not shield the aerial from the weather? In order to try this out we borrowed a large number of sunshades and umbrellas, which we affixed to the Professor's aerial so as to keep it always in the shade. Brilliant as the scheme was in theory, I regret to say that it did not prove very efficacious in practice, and unfortunately it ruined selectivity by introducing heavy gamping into the grid circuit of  $V_1$ . The Professor was of opinion that we were on the right lines, but that our sheltering devices were not complete enough. The aerial, he

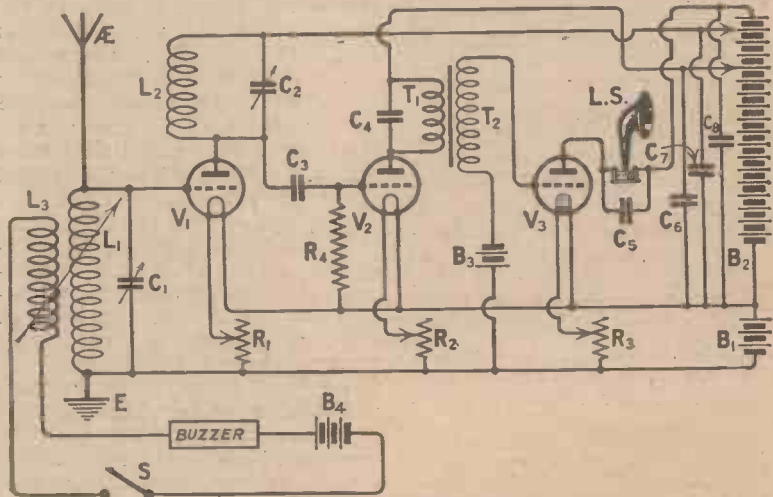

The Goop Atmospheric Drowner.

or very small, though, for the moment, I am unable to recall which. But the net result is that the atmospheric, so to speak, jostles and pushes and elbows its way through our signals and generally plays Old Harry with them. Many systems for the elimination of atmospherics have been tried. One of them demands the erection of two receiving aerials—one, say, in Little Puddleton and the other in Bilgewater Magna—with a receiving set located between them. Then all you have to do is to use one of them for receiving atmos-

pherics, must be kept at low temperature at all times of the year. This suggested an idea for the next experiment, which consisted in fixing up a frame aerial in an ice chest. We found that this gave a complete immunity from atmospherics, but owing to the fact that the chest was made of sheet iron it gave also a complete immunity from signals. We decided therefore to carry out some tests in the cold storage shed in which Mr. Brisket, our local butcher, keeps his prime English

beef before it is thawed out. These experiments, however, were ruined owing to the fact that our own honks, snorts and sneezes made it impossible for us to hear whether atmospheric were there or not.

**The Drowner**

When we came to talk the matter over later we arrived at the conclusion that any attempt to discover an eliminator for atmospheric was probably foredoomed to failure from various causes. We decided therefore to attack the problem from an entirely new and original angle. "It appears," I said to Professor Goop, "that we cannot prevent the pesky things from reaching the receiving set. This being so, the only method, so far as I can see, that is likely to be successful is one whose principle is somewhat akin to that of the neutrodyne. If you can have negative resistance why should you not have negative noise? All that you have to do is to feed into the aerial oscillations due to

negative noises that are exactly in phase with those produced by atmospheric. Mutual cancellation will then occur. And there you are." We are still working on these lines, but so far the negative noise

effective, and the Professor and I guarantee that if it is made up carefully and properly used not a sound due to atmospheric will be heard even with the most sensitive receiving set.

THE LISTENER-IN.



In Mr. Brisket's cold storage shed.

has eluded us. We have, however, evolved between us the device seen in the accompanying diagram, which works not by cancellation, but by drowning. A simple buzzer circuit containing the inductance  $L_3$  is wired up.  $L_3$  is closely coupled to  $L_1$  and the buzzer is adjusted until its note is just a little louder than the atmospheric. The latter are thus swamped and so rendered completely harmless. Tests have shown that the apparatus is most

**The "Prince" Receiver.**

SIR,—I have made the 3-valve "Prince" receiver, described by Mr. A. S. Clark in the January, 1926, issue of MODERN WIRELESS, using 2 Osram D.E.R. valves and a Wuncell W.3 valve, with a 200 Edison Bell coil, and the results are absolutely marvellous. The inability to get stations other than Daventry (with the exception of London) is more than made up for by the strength and purity obtained on 5XX. I use it for demonstration outside my shop, and it is most gratifying to hear the comments passed by listeners.—Yours truly, W. F. WEBB.

Cambridge.

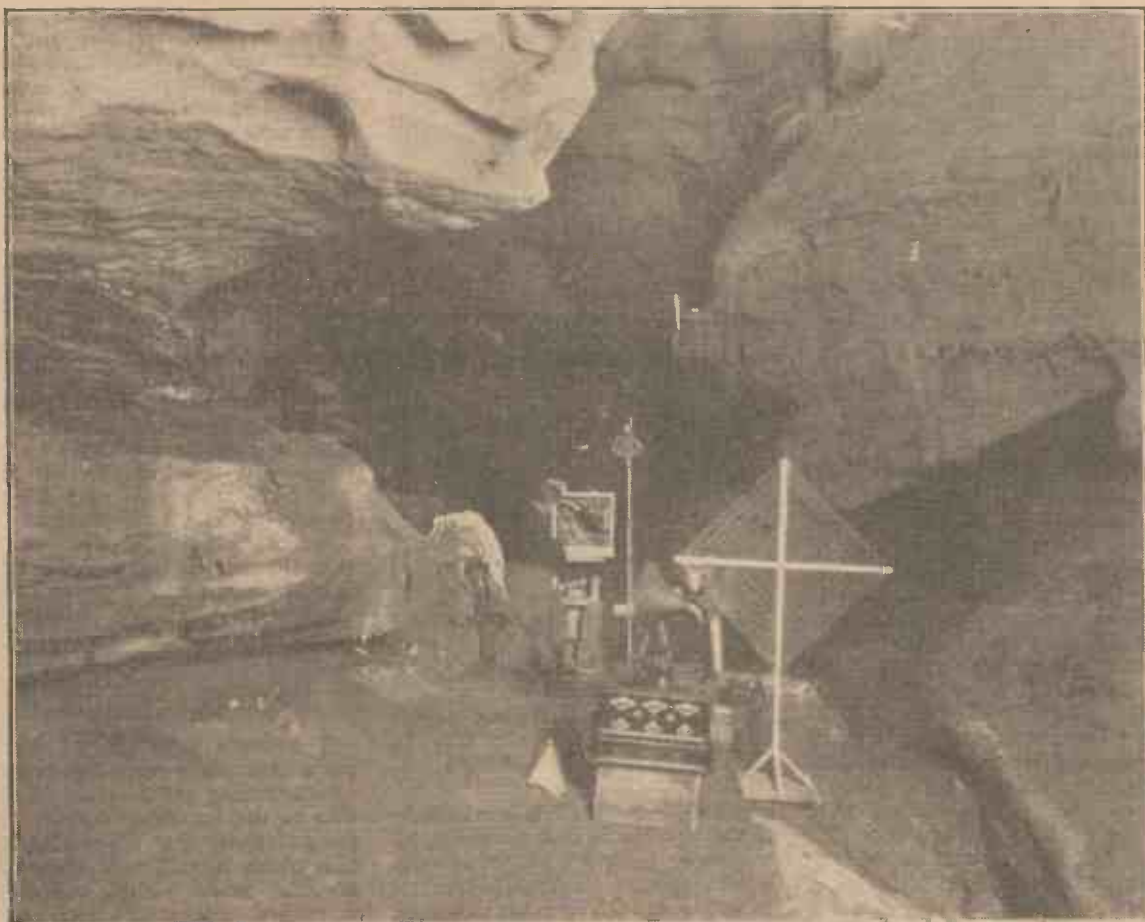

Mr. Fortous working 300 ft. underground and over a mile from the entrance of one of the New Market caverns. The receiving set keeps the artist in communication with the outside world.

# Some Interference Problems in Supersonic Heterodyne Reception

By

Capt. H. L. CROWTHER, M.Sc.

*Selectivity in a "superhet" is not always secured in practice and Capt. Crowther discusses many of the points to be observed.*



GREAT deal has been written about the wonderful selectivity of the supersonic heterodyne receiver, and one might imagine that after such a receiver had been installed all one's interference problems would be at an end, at least all the interference that can possibly be eliminated by the proper design of the receiver. This does not, of course, refer to unavoidable interference, which can only be cured at the transmitting stations. This ideal selectivity, however, applies at present to very few designs of supersonic heterodyne receivers. Although most of these receivers can separate two broadcast stations differing by about 20 kilocycles, very few designs are entirely free from another source of interference which may in some cases be quite serious. The choice of a superheterodyne receiver therefore requires considerable care in order to ensure entirely satisfactory results.

### Different Sources of Interference

Interference to broadcast reception may be divided into two classes. First, that caused by the transmitting station, which cannot be eliminated by any modification to the receiver, and, secondly, that due to faulty reception, which with proper precautions can be eliminated.

With regard to interference caused by transmission, it is, of course, quite impossible to eliminate harmonics if they are radiated from a transmitting aerial, since they may be exactly, or very near, the same frequency as that of the broadcast station which is being received. Damped spark transmissions are also another source of interference which cannot be eliminated at the receiver. An

arc station will also cause trouble owing to what is commonly known as "mush." This "mush" may cover quite a wide band of frequencies and is practically impossible to eliminate.

### Ordinary Interference Troubles Eliminated

All the ordinary interference troubles can be eliminated by means of supersonic heterodyne reception. There is, however, a special type of interference to

by any means be eliminated at the receiving station, if they happen to be of exactly or near the frequency of the broadcast station. For instance, a high-power station transmitting on, say, 100 kilocycles is liable to cause considerable interference on a number of stations in the broadcast band of frequencies, namely, at 600 k.c., 700 k.c., 800 k.c., 900 k.c. and 1,000 k.c. Fortunately the radiation of these harmonics can be prevented by proper design of the transmitting station, and this source of interference is gradually being eliminated, although there are still one or two stations which are well-known offenders in this direction.

### Superheterodynes and Long-Wave Interference

The long-wave interference that we are now concerned with is actually caused by the fundamental frequency of the station, and although the trouble can be overcome by proper design, the fact remains that many of the sets met with in practice are liable to give trouble in this direction if they are used anywhere near a high-power station. To understand why it is possible to get this type of interference one must have some understanding of the general principles of supersonic heterodyne reception.

### Principles of Supersonic Heterodyne Reception

The basic principle of supersonic heterodyne reception consists in converting the received oscillation of the broadcast station to a comparatively low frequency, but one which is still well above the audible scale. This conversion is carried out by the well-known method of beat reception by means of a local oscillator tuned to approximately the frequency of the

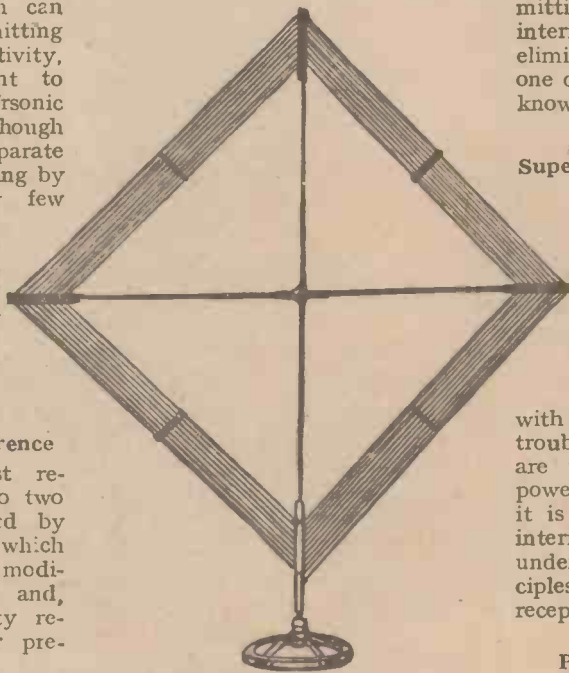

A double-wound frame aerial used by the Igranic Co. to prevent interference.

which a "superhet" is particularly liable. This is due to direct interference from a high-power long-wave station, a trouble which is not usually met with in other receivers. We have already mentioned that long-wave stations can cause interference by harmonics, which cannot

station received. The oscillator is adjusted to give a beat frequency well above audibility, that is, above 10 kilocycles. This beat, although inaudible, can be rectified by means of a valve and passed through an amplifier tuned to the frequency of the beat. This long-wave

**Intermediate Amplifier as Cause of Interference**

The intermediate frequency amplifier is naturally very sensitive to any oscillation which comes within its frequency band, and unless special precautions are taken it is liable to be influenced by

influence the intermediate transformers directly. Precautions must therefore be taken to prevent stray "pick up" on the frame aerial from influencing the intermediate amplifier, and also prevent the intermediate amplifier from being affected directly.

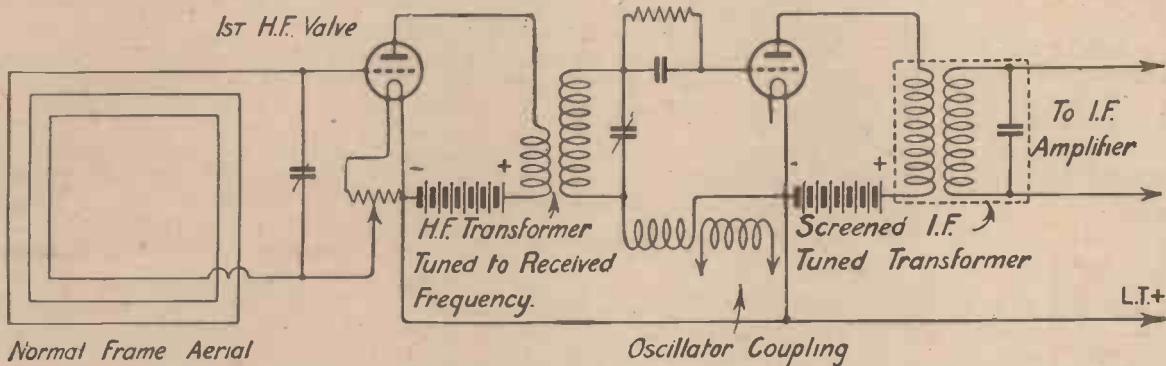

Fig. 1.—An initial stage of H.F. amplification in a "superhet" is useful for preventing long-wave pick-up.

amplifier usually consists of about 3 valve stages. After being amplified by this long-wave or intermediate amplifier, the signal is again rectified so as to convert it to an audible frequency, after which it is again amplified for the operation of the loud speaker. The intermediate amplifier is usually tuned to cover a definite narrow band of frequencies of about 20 kilocycles. By means of the oscillator control, all the frequencies of the different broadcast stations can be converted so as to suit the frequency band of the intermediate amplifier, the tuning of which remains fixed. For

any high-power station within that band of frequencies.

**Receiving the Long Wave Signal**

One might imagine that as the frame aerial circuit is tuned to the frequency of the broadcast station it would not pick up any long-wave station, particularly as it may be 10 or 20 times that of the broadcast wavelength. This, however, is not the case, and although the energy received by the frame aerial is comparatively small, it is, however, sufficient to give serious interference, particularly if reception is being carried out com-

**Result of Long-Wave "Pick Up"**

To cause interference the frequency of the high-power station must of course come within the frequency band of the intermediate frequency transformers which may be between 30 k.c. and 50 k.c. (10,000 and 6,000 metres wavelength). This, however, is a fairly wide band of frequency and may include several of the high-power stations.

Now the carrier frequency of our broadcast station beats with the local oscillator and produces an oscillation equivalent to about 40 kilocycles (7,500 metres), depending upon the adjustment of the oscilla-

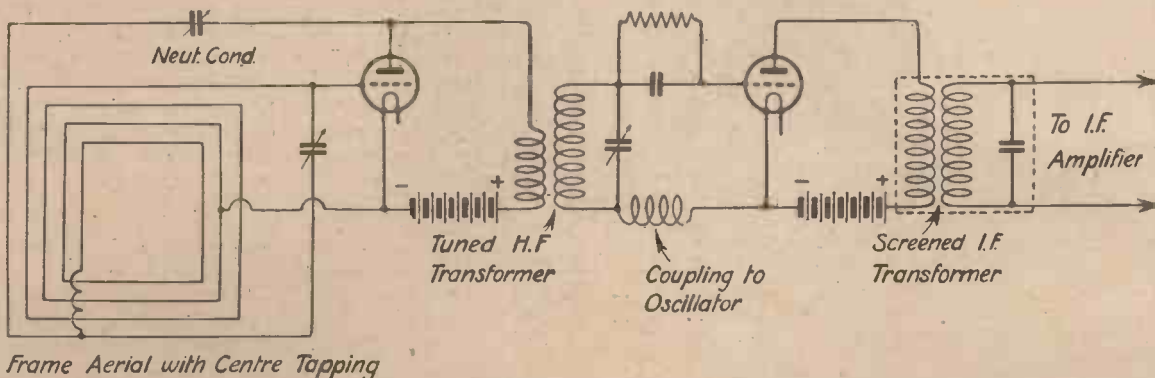

Fig. 2.—This circuit is similar to that of Fig. 1, but has a neutrodyne arrangement introduced.

example, if the intermediate amplifier is tuned to cover a frequency band from 30 kilocycles to 50 kilocycles, the oscillator is adjusted so that its frequency differs from the particular station to be received by approximately 40 kilocycles.

paratively near to one of these high-power stations. The energy thus received influences the grid of the 1st valve of the long-wave amplifier, and thus reaches the 2nd detector valve in a greatly amplified form. The radiation from these long-wave stations can also

tor, in the intermediate circuit. This frequency and the frequency of the incoming high-power station will thus beat together and give a heterodyne note which can be varied by the adjustment of the oscillator control. We shall thus get the note of a heterodyned continuous wave

which will usually come through as Morse. This interference is liable to occur as soon as the receiver is tuned to any broadcast station, no matter what its frequency. When the broadcast station shuts down the interfering station may not be heard at all, or only heard as faint hisses or clicks.

**How can this Interference be Eliminated?**

It is obvious that in order to get rid of this class of interference we must prevent both the frame aerial and the intermediate frequency transformers from being

the effect of filtering out the long-wave station, and only allowing the broadcast frequency to pass through. Such circuits are shown in Figs. 1 and 2. This precaution, however, complicates the receiver, and will probably mean an additional adjustment.

**Another Method**

Another method, which is probably much more simple, consists of using a double-wound frame aerial. The two windings are wound in opposite directions and joined in series. The complete winding is included in the grid circuit of the rectifying valve,

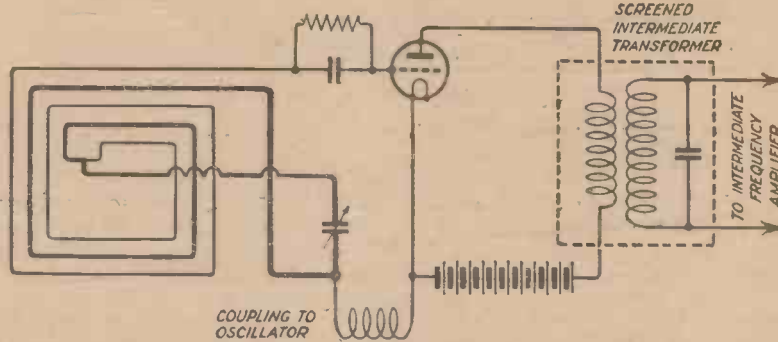

Fig. 3.—The circuit connections when using a double-wound frame aerial with windings in the opposite direction.

influenced by the radiation from the high-power station. There are two or more ways by which this can be one. First of all let us consider the direct "pick up" by the intermediate transformers. This can be eliminated by completely shielding the transformers, either independently or as a whole, by means of a copper case. The receiver as a whole may also be completely screened, but this is not usually so convenient as just screening the intermediate transformers. Another possible way of preventing the intermediate transformers from being influenced by radiation from a high-power station is to arrange them so that their plane is horizontal. In this position their "pick up" would probably be negligible in most cases.

**Preventing Aerial "Pick Up"**

If the aerial picks up an interfering station it is essential in some way to prevent the energy influencing the intermediate frequency circuits. This can be done by introducing a tuned high-frequency and possible neutrodyne valve circuit in front of the first rectifying valve. This will have

but only one half of the winding is tuned to the broadcast frequency by means of a variable condenser. As far as the long-wave stations are concerned the two halves of the aerial oppose each other and nothing is received, as the condenser across the one half of the winding can be neglected for these lower frequencies. The half of the frame which is tuned to the broadcast wave will receive these unhindered, the opposing winding having practically no influence. Such a circuit is shown in Fig. 3. This method was introduced by the Igranic Co., and is recommended by them for use in connection with their Six Valve Supersonic Heterodyne Kit.

**The "DX" Four Receiver**

Sir,—I have made up the wireless set "DX" Four described by D. J. S. Hartt, B.Sc., in the Oct., 1925, issue of MODERN WIRELESS, and, as requested, I give you the following report.

The lay-out, coils, etc., were made as directed, and the only change was in the make of components. I included Burndept corrected Square Law Condensers with Super Vernier Dials, R.I. Transformers, Burndept Rheostats and a Bretwood variable grid leak and condenser in place of Dorwood.

The claims made by Mr. Hartt are amply justified, and it is easily the most selective and powerful set I have yet handled. I have waited to test it thoroughly before writing. Glasgow, the local station, can be cut out quite easily, and all other main B.B.C. stations received on the loud speaker at really good strength, also some of the relay stations. The purity of tone is remarkable, and no distortion is present. Previous to this I worked with a crystal, then crystal and valve, two valve H.F. and L.F., 3 valves, and finally a four valve set. The circuit of the "DX Four" is easily ahead of them all, and the fact that the long-wave stations are outside its scope is made up for by the number of stations of the ordinary broadcast wave band that can be received.

Hamburg on the loud speaker was the first station to be tuned in, and the volume was such that I was under the impression it was Glasgow until the announcer spoke.

I append a list of the station readings on the two condensers.

With best wishes for Mr. Hartt's continued success in the design of wireless sets.—Yours faithfully, Blairhill, ALEX. S. THOM.

Coatbridge.

Aerial 65 ft. long, 40 ft. high, with a good outside earth.

London ..	68	67½	LS.	I have also logged many stations without taking readings e.g., Oslo, Milan, Radio Madrid, Rome, Dortmund, and many others I didn't get the name of. Also Leeds, Bradford, Nottingham, Dundee and Plymouth, Cardiff, Edinburgh, and Manchester appeared to be heterodyned sometimes by other stations.
Cardiff ..	62½	63	LS.	
Bournemouth ..	78	74	LS.	
Edinburgh ..	53	55	LS.	
Belfast ..	99	95	LS.	
Aberdeen ..	125½	117	LS.	
Manchester ..	73	71	LS.	
Newcastle ..	84	80½	LS.	
Birmingham ..	114½	106½	LS.	
Radio Cadiz ..	65	65	Phone	
Munster ..	87½	84	LS.	
Berlin ..	113	106	LS.	
Hamburg ..	80	78	LS.	
San Sebastian	60	60	LS.	



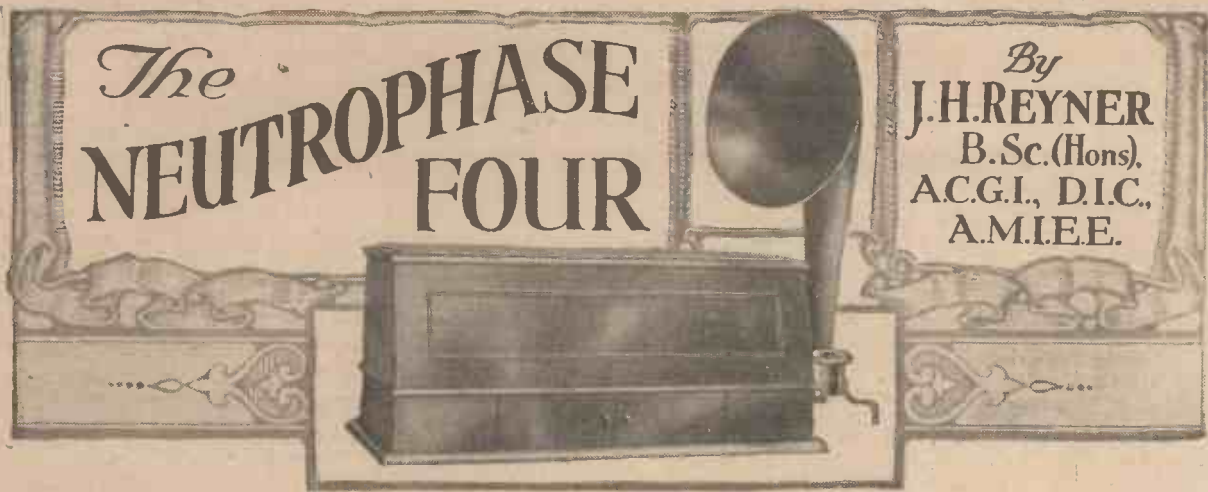

*This receiver is particularly selective, the neutrodyne arrangements being designed on symmetrical lines.*

**T**HE receiver described in this article is an attempt to produce an instrument capable of receiving the principal British and foreign stations with the maximum selectivity combined with simplicity of adjustment. In order to achieve this result all critical adjustments have been eliminated as far as possible.

It has been previously pointed out in these columns that in order to obtain really good selectivity without the sacrifice of quality at least three tuning controls are necessary. Otherwise there is a danger of cutting off some of the "side bands" produced by the modulation of the carrier wave by the speech or music.

**A Reaction Adjustment**

The use of a reaction adjustment is to be avoided, at any rate as a necessary control in receiving any station. A small "tickler" may be provided merely as an adjunct, but it is desirable to be able to receive the stations without recourse to reaction.

In order to conform with these requirements two high-frequency stages are advisable, and this arrangement has been adopted in the receiver in question.

**Good Results**

The results obtained were very satisfactory, it being possible to receive Manchester and Madrid free of London when the last

station was working. The only main adjustments are those of the three tuning controls. The other adjustments are placed on a separate panel and are not touched after the set has once been adjusted for the first time, the only variable being the aerial coupling unit as will be seen later.

**The Circuit**

The two high-frequency stages are neutrodyne, the circuit being as shown in Fig. 1. It will be seen that in all cases the whole coil is tuned, and the neutralising arrangements are symmetrical. This ensures that the phases of the feed back currents (through the valve capacities) and the neutralising

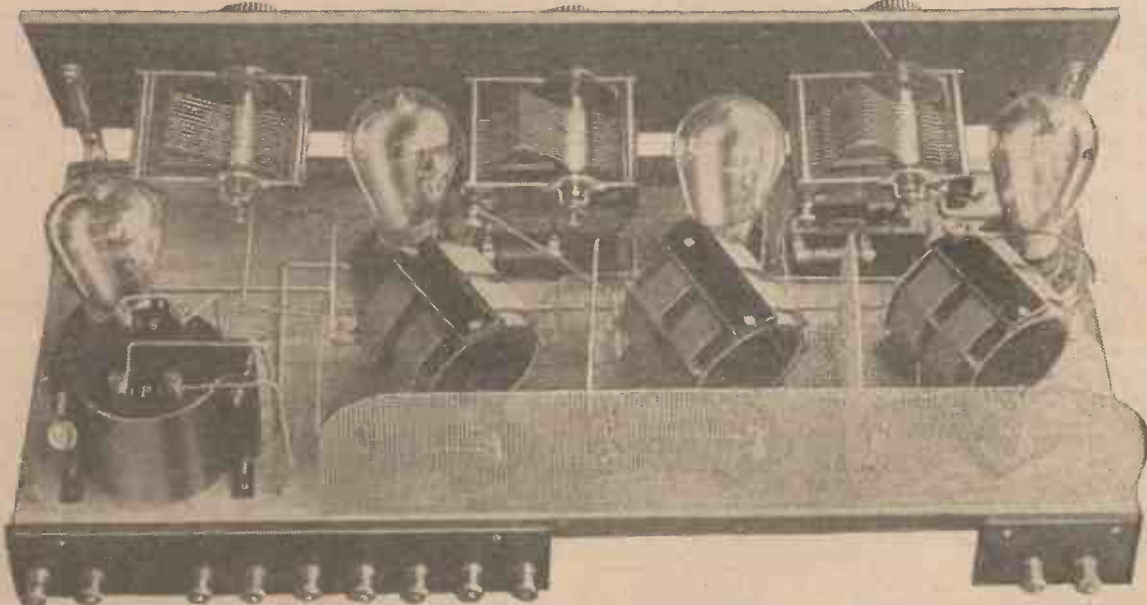

The layout of the components has been carefully thought out. Note the alignment of the "split" coils.

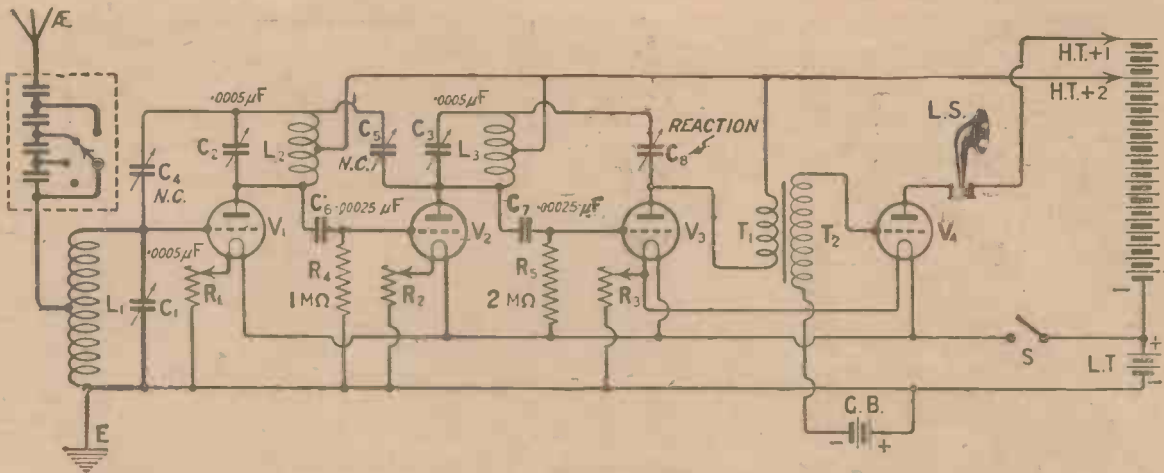

Fig. 1.—It will be seen that the two high-frequency valves are neutrodyne.

currents are always correctly opposite in phase. It is for this reason that I have called the receiver the "Neutrophase Four," since it is constructed on the symmetrical lines described in my article in the last issue of MODERN WIRELESS.

It should also be noted that with this arrangement the detector valve is tapped across only half the last tuned coil, so that the effect of the grid damping in this valve is reduced.

The Aerial Circuit

Finally, the aerial circuit assists to a large extent in obtaining the selectivity. The aerial is connected to the centre of the first grid coil, through a small condenser. This

condenser is variable in four steps between .0002  $\mu F$  and .0005  $\mu F$ . The smaller the condenser the greater the selectivity and this gives a convenient adjustment of coarse and fine tuning.

hold good over the whole tuning range and that "blind spots" would occur in the tuning range as has recently been pointed out by Mr. G. P. Kendall in these columns, but with the proportions given in this receiver no trouble will be experienced from this source.

Two Panels

The aerial coupling condenser has been made up for me by Messrs. Radio Instruments, Ltd., in a form similar to their Anode Reactance. It consists of four .0002  $\mu F$  capacities placed progressively in series so that capacities of .0002, .0001, .000066 and .00005  $\mu F$  are obtained in successive positions.

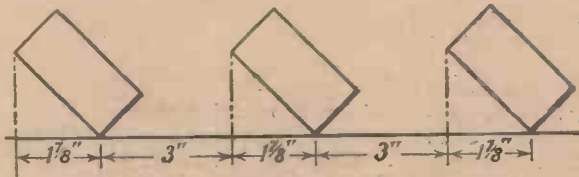

Fig. 2.—This diagram shows the exact positions of the coils.

Selectivity

The selectivity is achieved in three ways. In the first place reasonably low-loss coils are employed, the new "Dimic" coils manufactured by Messrs. L. McMichael, Ltd., being utilised. By using such an arrangement it is also possible to change the coils for others covering a different frequency range.

Secondly, the damping usually experienced in tuned anode circuits, due to the effect of the valve, has been considerably reduced. Normally the internal impedance of the valve (from anode to filament) is in parallel with the tuned circuit and this has the same effect as introducing resistance into the circuit.

Reducing Anode Damping

Capt. Crowther has recently shown that the selectivity and signal strength are both considerably improved by tapping the anode circuit across part of the coil only, so that the use of a centre-tapped arrangement results in a material increase in the selectivity.

With the object of rendering the control as simple as possible the receiver is provided with two panels. The main panel carries the three tuning condensers, the on-off switch and the reaction "tickler." The

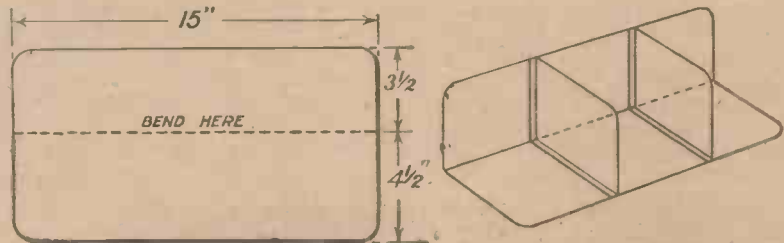

Fig. 3.—Details of the screen made from perforated zinc are shown here.

For searching, the switch is placed on the largest tapping, while as greater selectivity is required the series condenser is progressively reduced.

The signal strength is also slightly reduced at the same time.

No Blind Spots

It may be thought that the use of such an arrangement would not

filament rheostats and neutrodyne condensers are placed on a subsidiary panel, since these controls do not require to be touched in the normal operation of the set. The layout is unusual, and has also the merit of compactness, since the overall length is only 21 ins. As will be seen from the photographs the main panel is in a

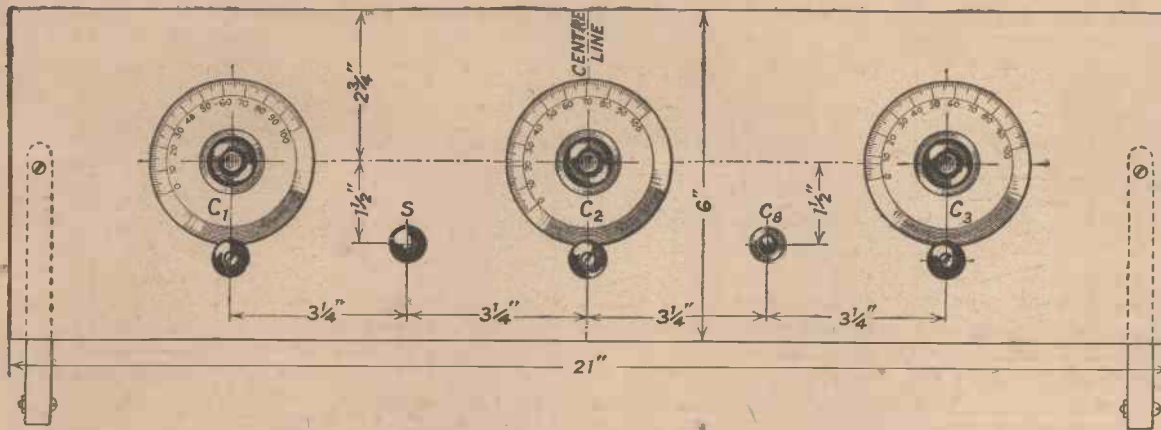

sloping position, and the cabinet is made in the form of a bureau, so that the whole may be closed up when not in use. The subsidiary panel is housed under the main panel and is accessible by opening the two doors at the bottom of the cabinet.

**Shielding**

In order to obtain the compact layout it is necessary for the tuning coils of the two high-frequency stages to be placed somewhat close together, the actual spacing being 5 ins. At such close quarters there is a certain liability to stray capacity couplings. Magnetic coupling may be eliminated to a large extent by placing the coils at suitable angles to each other as can be seen from the diagram giving the layout.

In order to obtain satisfactory results with such an arrangement, however, a somewhat critical adjustment of the actual positions of the coils is normally necessary, and this is undesirable.

A static screen has been placed between the coils, as will be seen from the figures and diagrams.

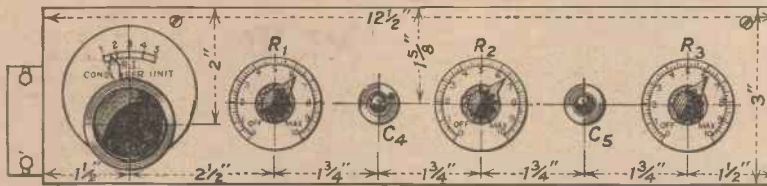

Drilling details for the two panels are given in this diagram. Blueprint No. 151a, post free 1/6.

This eliminates any stray capacity coupling between the coils and also reduces the magnetic coupling to a

interposition of the screen does not eliminate the magnetic coupling between adjacent coils, and it is essential to lay out the coils on the baseboard in the exact positions shown in

Fig. 2 in order to obtain satisfactory results.

The screen, however, does reduce

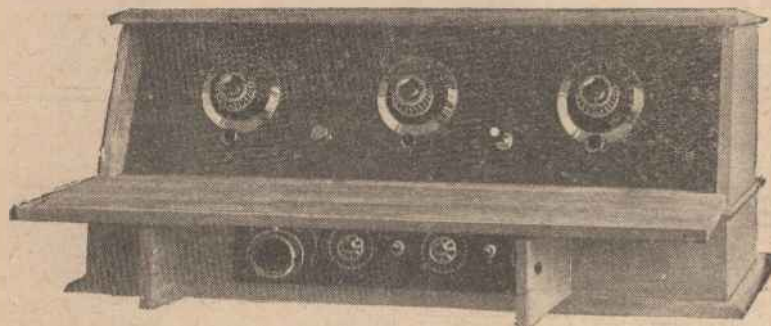

The appearance of the finished receiver is somewhat unique.

small extent, sufficient to render the positions of the coils not too critical.

It should be emphasised that the

the coupling between the first and third coils, and this effect combined with the reduction of the capacity coupling renders the receiver stable.

**Components**

The components required will be as follows. As usual the makers' names are given for the benefit of those readers who wish to make an exact copy of the receiver.

One Radion panel, 21 ins. by 6 ins. by 3/16 in. (American Hard Rubber Co., Ltd.).

One panel, 12 1/2 ins. by 3 ins. by 1/16 in. (American Hard Rubber Co., Ltd.).

One baseboard, 21 ins. by 9 ins. (W. H. Agar).

One special cabinet to suit (W. H. Agar).

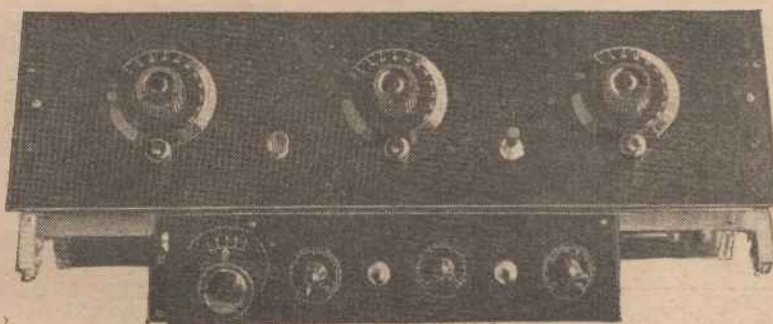

The controls on the main panel and sub-panel are symmetrically arranged.

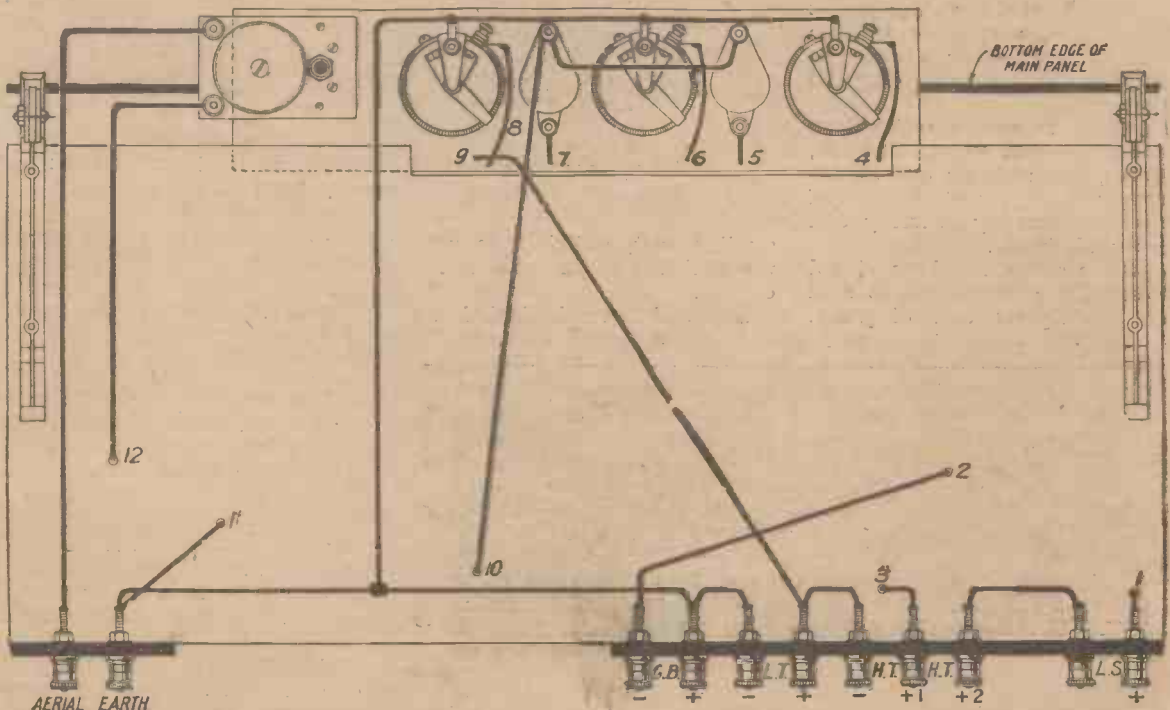
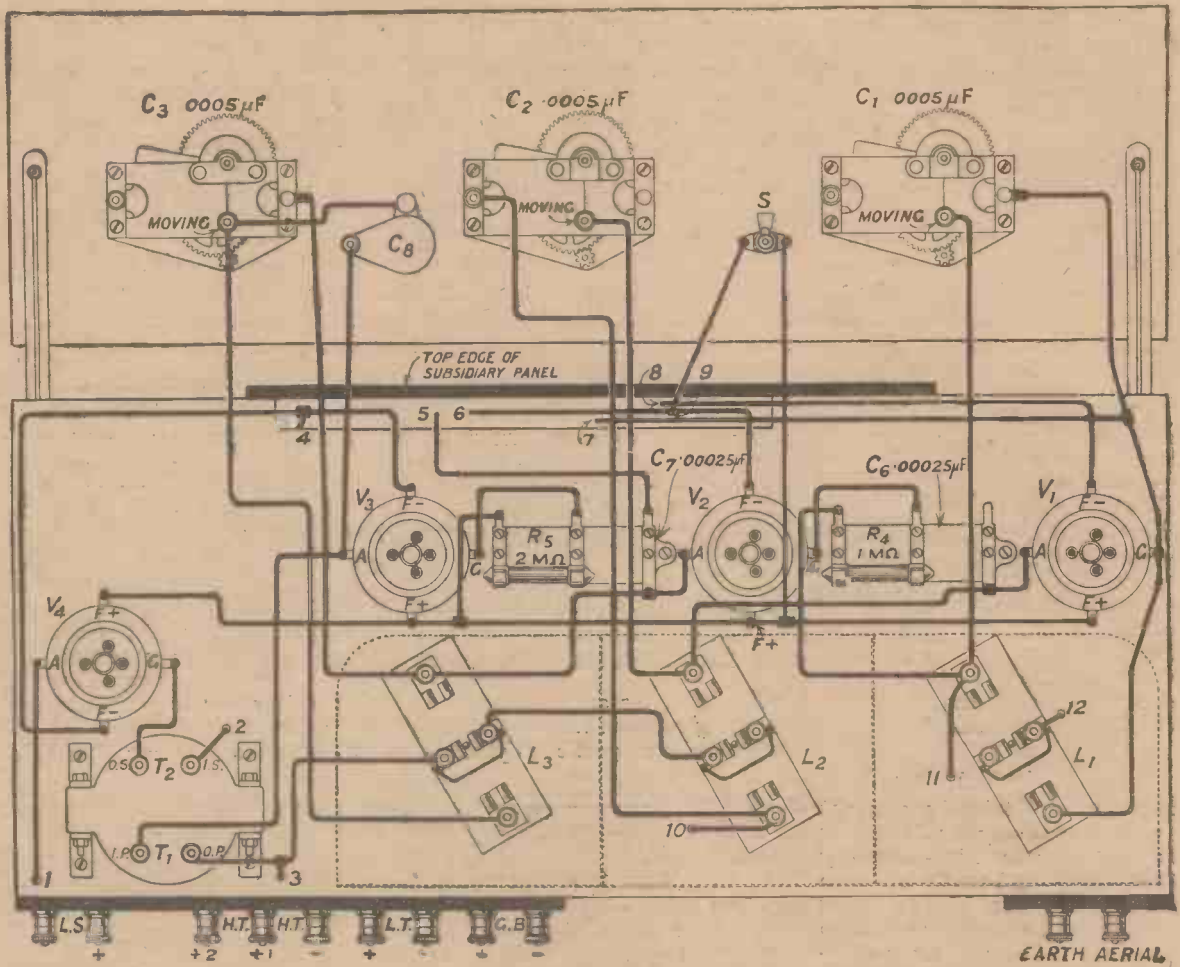

The wiring of the top and bottom of the baseboard can be followed from these diagrams. Blueprint No, 151b, post free, 1/6.

Three "Dimic" coils, No. 1. (L. McMichael, Ltd.).

Three Neutrodyne condensers (L. McMichael, Ltd.).

Three filament rheostats (Lissen, Ltd.).

Three .0005  $\mu F$  square law geared condensers (Jackson Bros.).

Three Radion 3 in. dials.

One Marconi Ideal transformer, 4:1 (Marconiphone Co., Ltd.).

Four antiphonic valve-holders (Lotus). (Garnett, Whiteley & Co.)

Two panel brackets (Formo Co.).

One on-off switch (Benjamin Electric Ltd.).

Two fixed condensers, .00025  $\mu F$  (Dubilier Condenser Co., Ltd.).

Two grid leak holders (Dubilier Condenser Co., Ltd.).

One 1-megohm leak (Dubilier Condenser Co., Ltd.).

One 2-megohm leak (Dubilier Condenser Co., Ltd.).

Two terminal panels as shown in diagrams (Peto Scott Co. Ltd.)

One special aerial coupling unit. (R. I., Ltd.).

Quantity of Glazite wire.

Piece of perforated zinc, 20 ins. by 8 ins.

Packet Radio Press panel trans-  
fers.

**Construction**

The construction is fairly straight-forward, and I shall confine my remarks to those portions of the receiver which require special precautions. The construction of the screen is one such portion. This component may be easily made up by cutting out a length 15 ins. by 8 ins. and bending it as shown in

Fig. 3. Do not bend it too sharply or it will break.

Then cut out two pieces 5 ins. by 4 ins. and fold over a piece  $\frac{1}{2}$  in. wide at two of the edges. These pieces will form the two projecting portions and may then be soldered to the main portion. In soldering, clean the zinc well, and do not make the iron too hot or the zinc will melt. The corners of the screen may be rounded if desired.

The components should be mounted up in three distinct operations. First the condensers, on-off switch and tickler condenser on the main panel. Then the aerial coupling unit, the three filament rheostats and the two neutrodyne condensers on the subsidiary panel, and finally the remainder of the components on the baseboard.

The baseboard components should be wired first, and the subsidiary panel attached. These components may then be wired, and no difficulty will present itself. The main panel should be mounted last, when the only wiring will be that of the three condensers, the switch and the tickler, which can all be carried out easily.

**Testing Out**

Test the receiver in the usual manner in order to ensure that the circuits are satisfactory, and that no harm will come to the valves when they are inserted.

Next insert the valves, connect up the batteries and tune in to the local station. Some little trouble may be experienced at first in finding the local station, which will not be heard if the circuits are much out of tune.

The best method is to place all the condenser dials to the same reading, and then to rotate all three condensers a little at a time, keeping the readings approximately the same. Having found the local station, tune in on all three condensers.

**Neutrodyning Correctly**

Now switch off the first valve. Signals will probably still be heard. Adjust the first neutrodyne condenser until the signals disappear. This valve is then correctly neutrodyne.

Repeat the process with the second valve, switching on the first valve and switching off the second for this test. Now switch on the second valve, when the receiver will be found to be stable over the whole of the range.

Distant stations may now be picked up by rotating each of the condensers one or two degrees at a time, one after the other. This method,

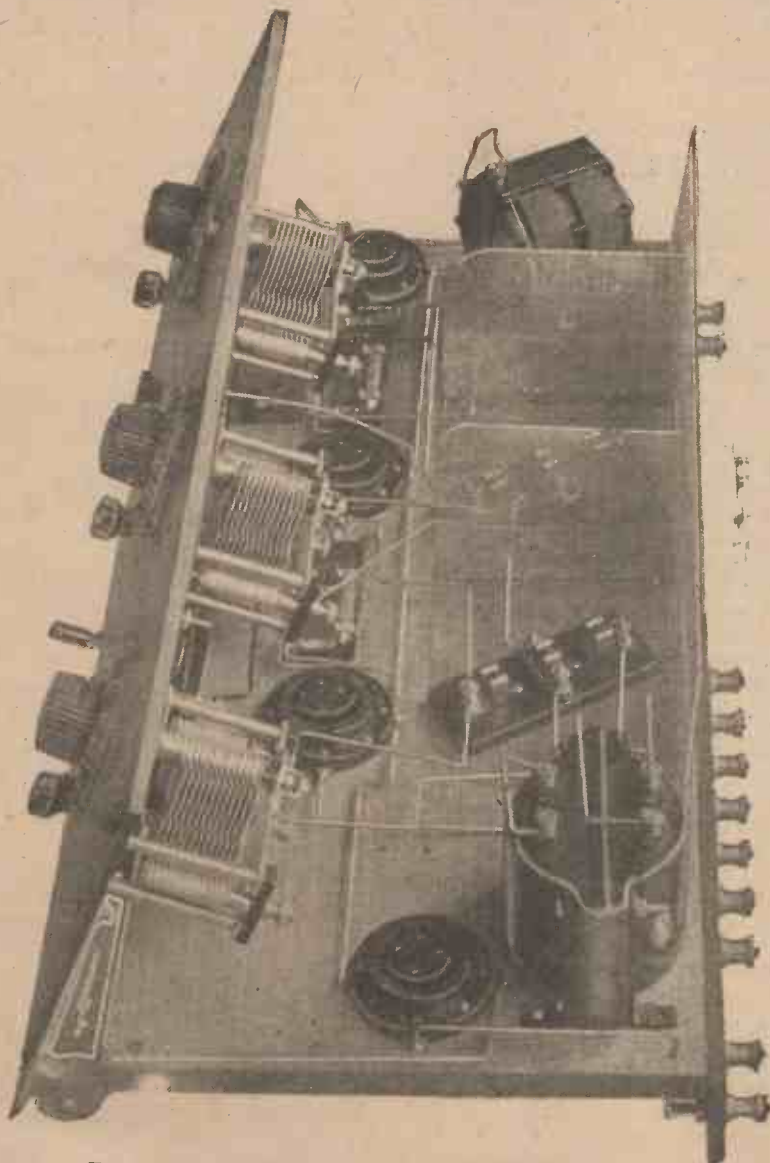

The position of the zinc screen is made clear by this photograph.

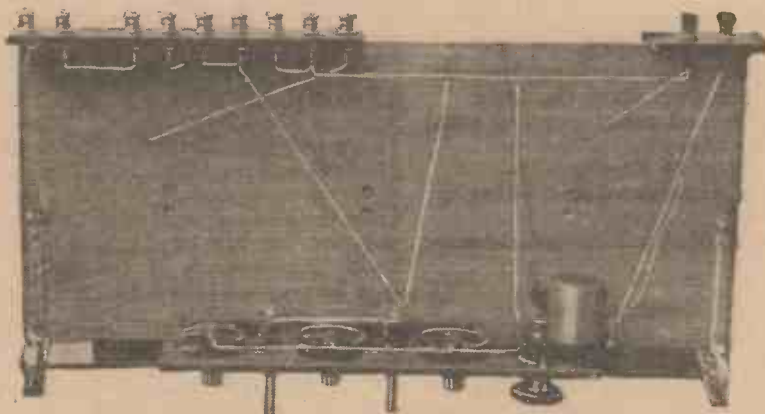

The wiring on the underside of the baseboard is quite straightforward.

though a little tedious, must be adopted in searching. When the various dial settings have once been found it is simply necessary to place the three condensers at the correct positions, when a small readjustment on all the three condensers will bring the station in.

As previously mentioned, the aerial condenser should be at a maximum when searching, and may be decreased to obtain greater selectivity. The reaction adjustment was not required in my case, all the stations being picked up without its aid.

Valves to Use

It is essential to employ high-impedance valves for the high-frequency stages. Such valves as the D.E.5B, D.E.3B or any of the various H.F. valves on the market will serve.

I actually used Marconi D.E.2 H.F. for the first three stages and a D.E.2 L.F. for the last stage.

Low-impedance valves must not be used, as the selectivity with such valves is very poor. This is due to the fact that when a tuned arrangement is employed the valve is shunted across the tuned circuit. These remarks must not be taken as applying to transformer-coupled types of H.F. amplifiers.

In some cases, it may be found that even when the receiver is correctly neutrodyned there are isolated portions of the scale at which oscillation occurs. A slight readjustment of the neutrodyne condensers will check the oscillation at once, and a position can be found for which the receiver is stable over the whole range.

## The Radio Press Year Book for 1926

WE have much pleasure in announcing that the *Radio Press Year Book* is now on sale, and our readers will no doubt be interested to learn something of the contents of this splendid production.

This "Wireless Book of Reference," as it has been very appropriately termed, is divided into sections, the first being a collection of authoritative articles written by men whose names are well known to the wireless public because of their expert knowledge of some particular branch of the art.

This is followed by a valve section in which detailed information is given regarding the types of valves to use for different purposes, and in addition a comprehensive list of valve data, together with a large number of characteristic curves, is included.

Then comes a portion dealing with simple wireless calculations in which the non-mathematical reader is led, with the aid of numerous examples, to a clear understanding of the methods of finding the inductances of given coils, of dealing with condensers in series or parallel, and of designing resistances. A valuable feature is the insertion of a useful table of frequencies and LC values and a metre-kilocycle conversion table.

For the constructor, there is a section devoted to hints upon set construction, while the experimenter has not been forgotten, inasmuch as he will find a most comprehensive and up-to-date list of amateur call signs, a list of Wireless Societies, and last, but not least, the international Morse code and the international abbreviations or "Q" signals.

Reverting to the general section of the book, we have an enlightening article entitled "Prophecies," from the pen of Mr. J. C. W. Reith, the managing director of the British Broadcasting Company; while Capt. H. J. Round, M.C., M.I.E.E., chief of the Research Department of Marconi's Wireless Telegraph Co., Ltd., contributes an exceedingly interesting article dealing with low-frequency magnification, in which he elucidates in a simple and practical manner many of the problems involved in the proper understanding of this subject.

Major James Robinson, D.Sc., Ph.D., F.Inst.P., discusses various methods of controlling oscillation in H.F. amplifiers, and Mr. J. H. Reyner, B.Sc. (Hons.), A.C.G.I., D.I.C., A.M.I.E.E., explains the meaning of coil resistance, and describes how the self-capacity of the coil, the spacing of the turns,

and the gauge of wire used all affect its general efficiency.

Capt. A. G. D. West, M.A., B.Sc., of the B.B.C. Engineering Staff, gives many valuable hints to those enthusiasts desirous of receiving American broadcasting. Capt. West's attempts at the retransmission of American programmes have made his name familiar to listeners in this country, and readers will be obtaining the benefit of much of his practical experience in this work.

In another feature of interest Mr. Percy W. Harris, M.I.R.E., draws a contrast between American and English radio conditions. Mr. Harris, it will be remembered, has made a thorough investigation of radio in the United States, and is in a position to give first-hand information on the subject. In further articles of technical appeal Mr. H. J. Barton-Chapple, Wh.Sch., B.Sc. (Hons.), A.C.G.I., D.I.C., A.M.I.E.E., deals with the Effects of Self-Capacity in Inductance Coils; Capt. H. L. Crowther, M.Sc., gives some authoritative facts about Valve Filaments; while Capt. Jack Frost, of the B.B.C., in his article entitled "Getting the Best from Your Aerial," discusses many points which often escape the attention of the beginner in erecting his aerial.

# Removing a Misunderstanding

*A Chat on Valve Constants.*



*The misunderstanding that exists through the use of a wrong name for an important valve constant is explained in this article.*

THE questions of nomenclature and terms in the sphere of wireless have unfortunately not been reduced to the same level as in the other arts and sciences. This can, perhaps, be excused when it is remembered that wireless is really only in its infancy, and can trace its material growth from the beginning of this century, which growth has been most rapid since the end of the war. Several commissions and committees have been appointed to deal with the question of symbols, terms and definitions, and it is pleasing to record that many lists have been drawn up making definite recommendations for British, and sometimes universal, adoption.

### Avoiding Confusion

In order to avoid confusion, it is really necessary for all those interested in wireless, either as a hobby or as a daily occupation, to keep in touch with these issued lists, so as to keep abreast of progress. In the light of these remarks, it will be found beneficial if attention is turned to the British Engineering Standards Association's Handbook No. 166, which contains a list of accepted terms and definitions used in radio communication. The primary object of this short article, however, is to clear up a misunderstanding which, unfortunately, exists concerning valve data. It has been common practice to speak of the *amplification factor* of a valve when dealing with a particular constant of the valve itself. This term, however, is erroneous and should be represented by the correct one, namely, *amplification ratio*.

### The Amplification Ratio

Referring to the previously-mentioned list, we find amplification ratio defined in these words—  
“The numerical ratio of the slope of the anode current/grid voltage characteristic curve to the

slope of the anode current/anode voltage characteristic curve of the three-electrode thermionic valve, the slope in each case being at that point representing the particular adjustment under consideration.”

### Examining the Definition

Examining this definition, it should be quite clear that this ratio is a definite number, found by dividing the change in anode volts to produce a small change in anode current by the change in grid volts necessary to bring about the same anode current change. Taking a particular example, if we find that it requires 18 anode volts to bring about a small change in anode current, say, 0.3 milliamp., when the grid volts are constant, and for the same anode current alteration 2 volts change in grid pressure is necessary when the anode voltage is constant, then the amplification ratio (generally denoted by the symbol  $\mu$ ) is simply  $\frac{18}{2} = 9$ .

### A Caution

It is necessary to bear in mind that calculations of this nature should always be made on what is popularly termed the “straight part” of the characteristic of a valve, *i.e.*, the portion of the static characteristic between the top and bottom bends, and at that point which represents the particular part under consideration, the filament current or voltage being generally that stated in the manufacturer's rating.

### An Inherent Property

It is known by all valve users that if a definite change of voltage is applied to the grid or control electrode of the thermionic valve, it will produce a much larger alteration in anode current than if the same potential change was applied to the



anode. This inherent property is brought about for many reasons. The electric field produced between the grid and filament exerts a definite influence in the path of the electron flow from the incandescent filament to the anode.

**Actual Magnitude**

It should be clear that the actual magnitude of the amplification ratio will be mainly dependent upon the dimensions of the three electrodes, the size of the grid mesh or closeness of the grid spiral, and also the relative distances between the filament, grid and anode. According to the particular purpose of the valve, this figure will vary between the approximate limits of 4 and 20.

Now all these remarks have been made concerning the quantity called amplification ratio. Turning to the misused term, namely, amplification factor, let us briefly examine its true meaning in order to avoid further confusion.

**Amplification Factor**

Referring once more to the list of terms and definitions mentioned previously, we find amplification factor defined in the following words:—

“The ratio of the power, voltage, or current available at the output terminals of an amplifying device to the power, voltage, or current at the input terminals under certain specified conditions, such as given output or given input. The amplitude in each case must be such that no saturation or threshold effects of any kind are involved.”

**An Amplifying Device**

Now for operating any amplifying device using valves, it is necessary to have some associated apparatus in the anode circuit, such as a choke, transformer winding, etc., and this offers a definite impedance to the flow of alternating current in the anode circuit. Now it should be appreciated that the anode to filament impedance of the valve itself cannot be neglected in comparison with this added



A typical valve with a low amplification ratio.

external impedance, and, consequently, the total impedance of the circuit must be used for calculation purposes.

**The Final Result**

The actual mathematical derivation of the amplification factor will not be given here, but

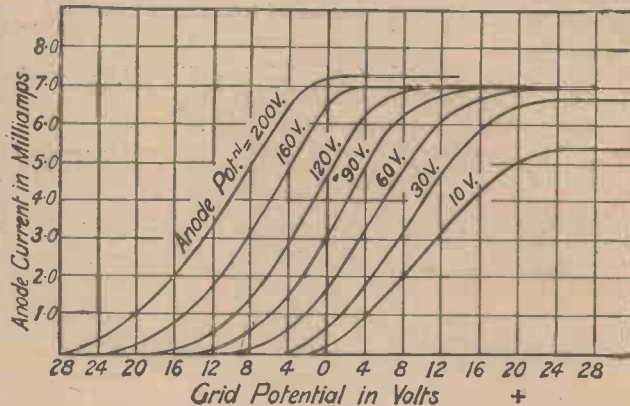

Characteristic curves similar to those shown in the figure are used for determining graphically the amplification ratio of a valve.

the final result is of importance. It enables the magnitude of, say, the voltage amplification of an L.F. amplifier to be determined, and expressed in symbolical form this becomes

$$\text{Amplification factor} = \frac{\mu Z}{\sqrt{R_0^2 + Z^2}}$$

where Z = external impedance in anode circuit in ohms.

R<sub>0</sub> = internal anode to filament impedance of the valve in ohms.

μ = amplification ratio.

**General Remarks**

It is thus clear that, while the amplification factor is dependent upon the amplification ratio, the two quantities must be treated separately.

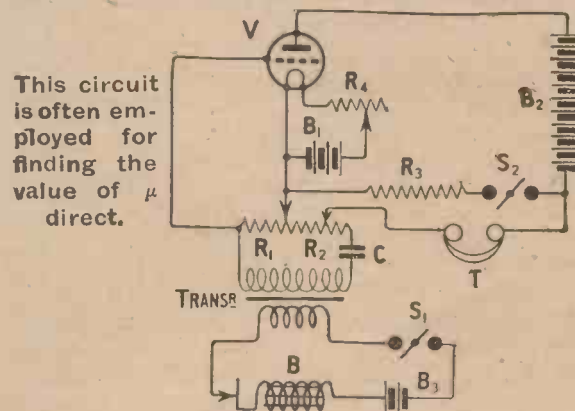

This circuit is often employed for finding the value of μ direct.

The two quantities only become equal when the added external impedance becomes infinity, and, of course, this is a hypothetical case. Consequently the value published by valve manufacturers as amplification factor must be read as amplification ratio, and a good average of the amplification factor to expect in general practice can be taken to be μ/2.

H. J. B. C.



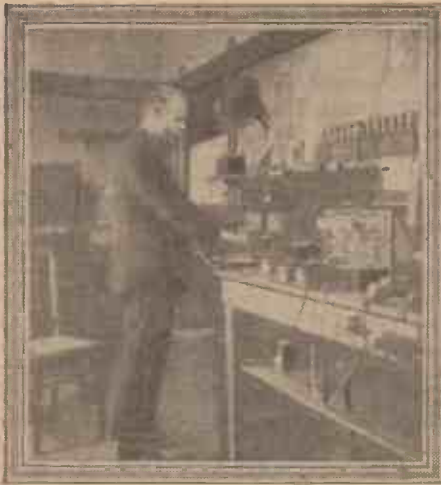

*The* HILVERSUM  
BROADCASTING  
STATION

By  
Capt. L. F. PLUGGE,  
B.Sc., F.R.Ae.S., F.R.Met.S.

*An interesting account of the developments made at the Hilversum station since the early days of broadcasting.*

HOLLAND claims the privilege of being the first country in Europe where the broadcasting of music took place. Many of us no doubt remember the early Hague concerts, and in those days and the years that followed there were in Holland a great number of amateurs who transmitted music from time to time. These concerts were either organised by themselves, or subsidised by firms wishing to gain a little advertising through the new medium. It is in this manner that a certain Mynheer Van Dyck, of the Hague, arranged with the *Daily Mail* to broadcast concerts for British listeners on certain Sunday afternoons, which some of us may remember.

**Early Transmissions**

Among these small early experimental stations was included a station run by the *Nederlandsche Seintoestellen Fabriek* of Hilversum. The difference between this small experimental station and the others is that it still exists to-day and is working, whereas all the other pioneers have gradually fallen out from the ranks of transmitters.

The Hilversum Station, however, is no longer the 100 watt installation of years gone by, neither is it any longer owned by the *Nederlandsche Seintoestellen Fabriek*, although the aerial from which programmes are transmitted is still built up on some waste ground belonging to that company. This ground is rented by the new Dutch company which is at present running the station.

**The New Station**

The company is called the

*Hilversumsche Draadlooze Omroep*. A long history attaches itself to the formation and development of this company and its station, but it has now become one of the important high power stations of the

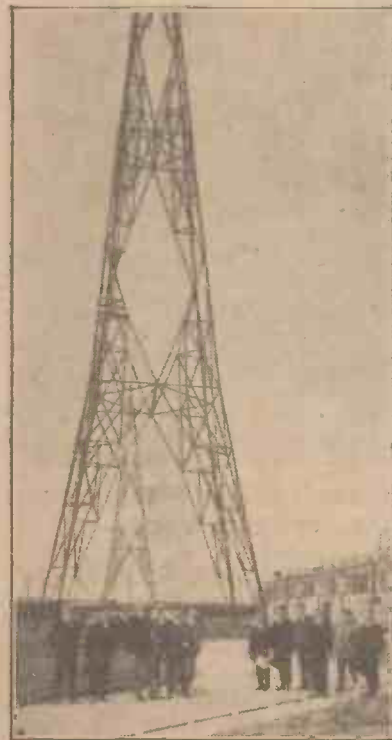

The self-supporting lattice towers are conspicuous in this photograph.

Continent of Europe. At present there is really no other broadcasting station in Holland except Hilversum, and it is certainly an interesting one in many respects.

The Hilversum Station is entirely run on voluntary contributions at present, but in the near future there are to be many changes in the organisation of broadcasting in Holland, of which I will speak later.

**Working Expenses**

Two years ago a special demand for funds was circulated and six thousand gulden were contributed to the expenses of the station as a result of this appeal. The money was expended in a shorter period than had been anticipated, and about a year later a second demand was sent out, and the result of this appeal was much more tangible as a sum no smaller than 17,000 gulden was collected. As the present rate of exchange of the gulden is twelve to the pound, this contribution is certainly somewhat considerable, and shows the interest which is taken by the Dutch people in broadcasting as a whole.

The *Hilversumsche Draadlooze Omroep* were expecting some definite settlement by the Dutch Government of the future of broadcasting, and they had hoped that this second appeal would have been the last one. However, a third appeal was decided upon a short time ago, and the result was again excellent, as a sum of 20,000 gulden was subscribed.

**English Associations**

It will no doubt be a pleasure for readers to learn that the chief engineer of this station, and the man who has been associated with its development from the very start, is an Englishman. I am referring to Mr. W. G. White, chief engineer of the Hilversum Broadcasting

Station. Mr. White has created a name with reference to the technical side of broadcasting which is unequalled in Holland, and he has been on certain occasions entrusted by the Dutch Government with special confidential naval work.

It has not been an easy task for those early pioneers to have evolved from the original station of the N.S.F. the model station which Hilversum is to-day. In addition to Mr. White, a good deal is owing to Mynheer Vogt, who has been called the father of broadcasting in Holland. Mr. Vogt's energy and perseverance, his optimism and his wise insight

Holland a month ago, and he kindly showed me round the installation at Hilversum. An excellent linguist, Mr. Vogt is a great friend of our country, and often takes the Hook of Holland boat to visit London for a week-end.

**Self-supporting Towers**

Hilversum is a picturesque village on the north-west of Amsterdam near the borders of the Zuider Zee. It takes approximately one hour by train to reach Hilversum from Amsterdam. On leaving the railway station one is driven along a main road on the one side of which is a very comical-looking steam tram. This tram has been running for the

gether on the insulator above the lead-in and brought into the operating room. The studio and the transmitting room are all housed in a one-storey building, situated at the north end of the aerial.

**The Studio**

The studio is entirely unconventional, and in going into it one can realise and appreciate the difficulties with which Mr. Vogt is faced to produce something that is really efficient. The operating rooms are a mass of experimental sets and experimental installations and circuits, and in looking around one dare not imagine what would



The transmitting apparatus of the Hilversum station does not appear to follow any orthodox lay-out.

into the future, have given him the courage and the energy to pursue his ideals, and he must feel proud to-day, as indeed are all the Dutch people, of the achievement of the Hilversumsche Draadloze Omroep station of the present day.

**The Dutch Radio Times**

Mynheer Vogt, in addition to being secretary of the Dutch Broadcasting Station, is also the Editor of the Dutch *Radio Times*, which is called *Radio Luistergids*. I was fortunate enough to meet him when I last visited

last thirty years, and it is not difficult to realise this by mere appearances. On going some distance down this avenue and turning sharp to the right, one is confronted by two monumental steel lattice towers in the shape of vast triangles. They are what one describes as "self-supporting" towers, as they do not depend on stay wires for their rigidity.

The aerial is composed of three parallel wires some 200 feet long and about 150 feet high. The lead-down to the station is by means of three wires which are joined to-

happen to Hilversum transmissions if anything were to happen to Mr. White.

The microphone, which is of the magnetophone type, is similar in appearance to that which is used at our London station. It is slightly smaller in diameter, and Mr. White told me that it was of the N.S.F.'s own manufacture, and only made on the principle of the magnetophone. It is not, however, a mere copy of the original, but is considered to be a marked improvement. The instrument was suspended in the usual manner on an

india-rubber sponge. The studio is not large, although it can comfortably hold a fair-sized band.

**Personal Messages Banned**

Among the noticeable points which drew my attention I might mention a large card hung up on the wall in front of the microphone on which it was said that those who were speaking were not allowed to go beyond the subject which had been agreed. Mr. Vogt explained to me that this ruling had been necessary as speakers, even men of repute such as University Professors had, to his great surprise, made use of the microphone whilst they were before it to give out personal messages. Although Mr. Vogt does not object to an author referring to his books, he does expect that people who use the microphone should keep to the

towards the end of January, so listeners should already have noticed the change by the time that this article appears in print.

The Hilversumsche Draadlooze Omroep Company are very ambitious in their scheme, as they do not hesitate to forecast that Hilversum will become the second Daventry of Europe.

**Reorganisation Pending**

The Broadcasting Service in Holland is at present undergoing great changes, and it is likely that within the next two or three months entirely stabilised conditions will be reached. Funds will be supplied by means of licences. There is at present sitting a Parliamentary Commission to decide what the future of broadcasting is to be. Just as in other countries, a certain amount of apprehension is felt



A view of the studio while the orchestra are playing chamber music.

text which they have previously submitted to him, and to which he has agreed.

**Increased Power**

Rumours have been circulated recently about the proposed increasing of power of the Hilversum Station, and I am pleased to be able to confirm this rumour, as I received the good news from the mouth of the chief engineer himself. It is proposed to change the installation to a certain extent, and to use an arrangement which, it is estimated, will radiate 20 kilowatts. A single water-cooled valve will be used, which has already been tested up to 75 kw. It was hoped that the station would transmit on this new power

owing to the mingling of radio, religion and politics. In Holland religion plays a great part in politics, and there are a very great number of political parties.

However, it is interesting to note that the Commission is composed of strong men, and among the members of the Sub-Commission, whose duty it is to deal with the technical side of the question, we notice Herr Dubois, the Chairman of the Nederlandsche Seintoestellen Fabriek, and also Mr. Veln, representative of Standard Telephones and Cables, Ltd., in Holland.

**Future Policy**

Apart from the question of licences, the Commission will also have to decide as to what policy

will be adopted with regard to broadcasting stations. Holland is a small country, and a great number of Dutch wireless enthusiasts are in favour of one powerful station only, as against a larger number of smaller stations.

However, let us send our very best wishes to the Commission, and hope that their labours will result in a stabilised condition for the betterment of radio in Holland and in Europe generally.

□□□□□□□□□□□□□□□□□□□□  
□ The "Special Five" □  
□□□□□□□□□□□□□□□□□□□□

SIR,—Just before Christmas I made the "Special Five," constructional details of which appeared in the November 1925 issue of MODERN WIRELESS.

I have purposely postponed writing to you offering my congratulations on this excellent set so that I might have time to get over the period (which no doubt every enthusiast has upon completing a new set) of "first thrills." However, I can now genuinely say that it is by far the best set I have ever handled, and as most of the best-known commercial sets have at various times passed through my hands, you will appreciate that this is intended to be a compliment to Mr. Harris. To anyone who has made the ordinary type of 4 or 5 valve set and who realises its limitations owing to its lack of selectivity, this set is the one to make. Here at Market Harbourough I have a 100-foot, single wire aerial and can get all main and relay stations on the loud-speaker and, of course, the usual crop of Continentals. Apart from the purity with which these come through, the thing which I think impresses me most is the way in which the slightest touch on the H.F. condensers cuts out the local station, passes through a section of complete silence and then merges into the next station, which comes through without the slightest suspicion of interference. I have used Pelican Univernier dials (a good geared dial and condenser I think is a necessity), and have followed the instructions exactly. I see in the January 1926 issue of MODERN WIRELESS that instructions are given for making the H.F. transformers, but, personally, I should not tackle this task.

I am afraid this is rather late, but in conclusion I must say this is just the set for an enthusiast,  
—Yours truly,

GLANVILLE BLACKMORE,  
Market Harbourough.

# Developments in Neutrodyne Reception

By the Staff of the Radio Press Laboratories.

ANYONE who has attempted neutrodyne reception, and more particularly anyone who has designed neutrodyne circuits, knows of some of the difficulties that are met with in this type of work. Some of these difficulties have been discussed by Mr. J. H. Reyner in last month's issue of MODERN WIRELESS.

## A Fundamental Neutrodyne Circuit

There are several different types of neutrodyne circuits which are in common use at the present time, but we shall limit ourselves in this article to the consideration of what might be termed the fundamental or true neutrodyne circuit in which the effect of the inter-electrode capacity of the valve is balanced out by means of a simple "bridge circuit connection," such as is shown in Fig. 1. We shall not consider neutrodyne circuits in which stray effects, both electro-magnetic and electrostatic, are balanced out by some form of reversed electro-magnetic reaction.

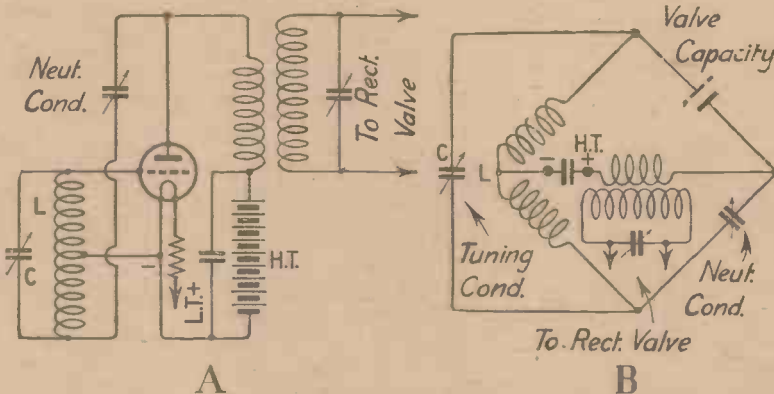

Fig. 1.—The neutrodyne circuit A can be regarded as a bridge arrangement as shown at B.

## Eliminating Stray Effects

Referring to Fig. 1A, it would appear that the circuit is perfectly straightforward, and that no difficulties would be experienced in actually operating the circuit in practice. By a proper layout of the circuit, and careful wiring, it is possible practically to eliminate all stray electromagnetic reaction effects between the circuits, and by testing the circuit by exciting the grid circuit of the first valve, with its filament disconnected, an almost perfect zero signal can be obtained by the correct adjustment of the neutrodyne condenser. This proves that the tuned grid and anode circuits are not reacting on one another, on the band of frequencies under consideration.

## A Parasitic Oscillation

On testing out the circuit under working conditions, however, it is often found that a comparatively low value of high tension has to be employed in order to obtain stability. The circuit does not

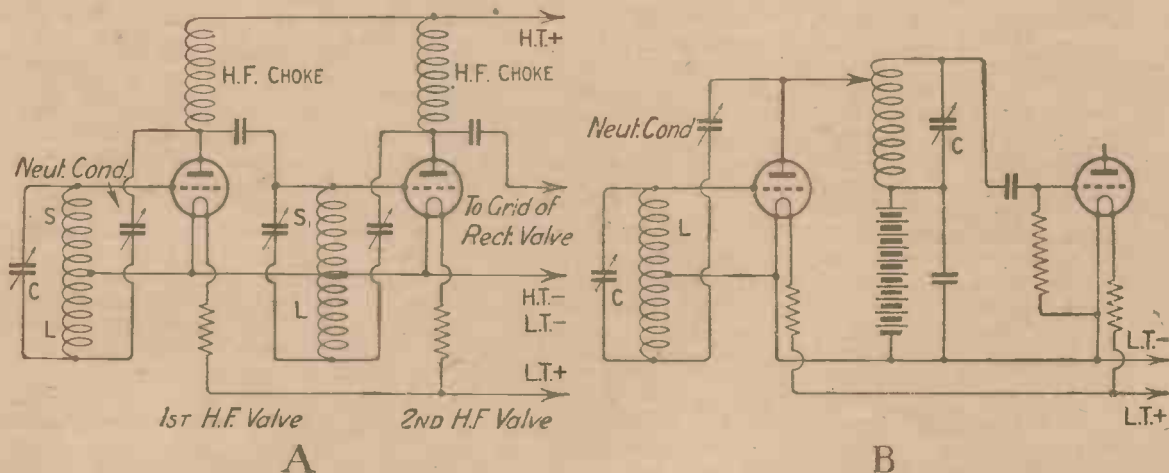

Fig. 2.—The parasitic oscillations to which circuit A is subject are reduced by the arrangement B.

tend to oscillate at the frequency for which it is tuned, but at some other frequency which will be found to be somewhere between 5,000 and 15,000 kilocycles, depending on various circuit constants. This parasitic oscillation is practically independent

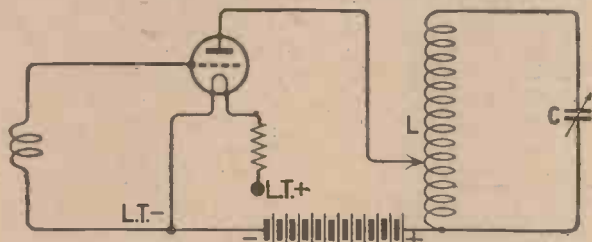

Fig. 3.—This simple circuit will oscillate at a very high frequency.

of the tuning of the grid and anode circuits. This high frequency oscillation is, of course, fatal to the reception of signals, as the whole set becomes "dead." The greater the number of high-frequency valves used, the more persistent does this oscillation appear to become.

**Neutrodyne Condensers not Completely Effective**

It might be imagined that, once the neutrodyne condenser is properly adjusted, all stray reaction effects due to inter-electrode valve capacity would be balanced out, and that under no circumstances would there be any tendency for any part of the circuit to oscillate. This, however, is not the case, and we can see that, if we examine a circuit as shown in Fig. 2A, although the circuit can be properly neutrodyned for any frequency corresponding to the circuit L C, it is not neutrodyned for a circuit which is controlled by the natural frequency of the grid circuit, which consists of half

the inductance L and the associated valve capacity. If now the natural frequency of the anode circuit, which consists of the anode inductance and the valve capacity, is of a similar value to that of the grid circuit, the valve will oscillate at this frequency, independently of whether the circuit is neutrodyned or not. The frequency of the oscillation is practically independent of either of the variable condensers, but can be altered by varying the value of the inductance in the anode and grid circuits. If the anode circuit of the valve is tapped across practically the whole of the coil, so that the anode circuit is tuned as a whole by means of the condenser C, as shown in Fig. 2B, then there is apparently no tendency towards high frequency oscillation. The circuit thus becomes unstable when the turns in the anode consist of only a small part of the complete coil.

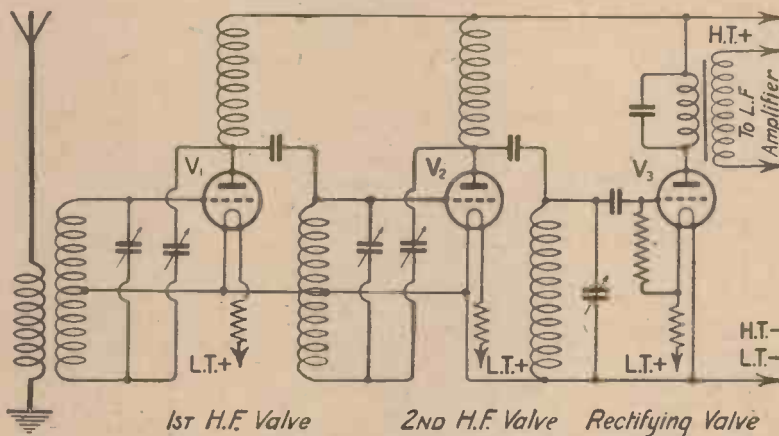

Fig. 4.—The first H.F. valve of this circuit will tend to generate parasitic oscillations.

**A More Simple Circuit**

We can consider an even more simple circuit, as shown in Fig. 3, and still get this parasitic high-frequency oscillation. The grid circuit simply consists of a coil of a few turns of wire, the anode and filament of the valve being connected across part of a tuned circuit, which may be coupled to a rectifying valve. With a suitable anode tapping; which is not at all critical, the circuit will oscillate at a high frequency which is independent of the frequency of the circuit LC.

**Typical Neutrodyne Circuits**

If we now consider one or two of the ordinary neutrodyne circuits we shall see that conditions are generally suitable for the generation of a parasitic high-frequency oscillation. Typical neutrodyne circuits are shown in Figs. 4 and 5, from which it will be seen that in each case both the anode and grid are tapped across part of the tuned oscillatory circuits, which we have seen favours the generation

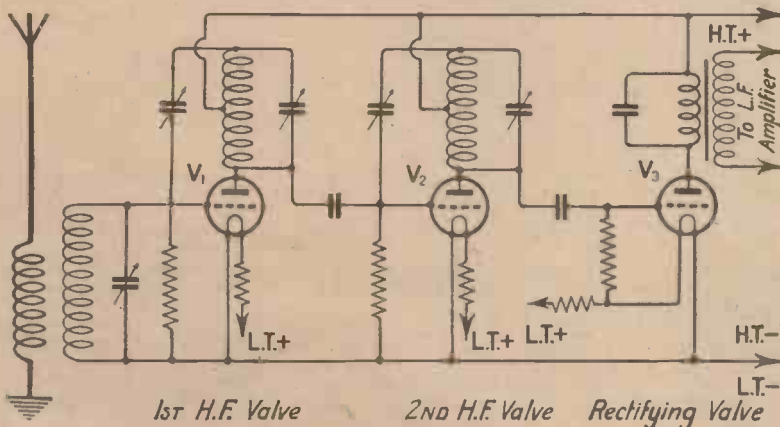

Fig. 5.—In this rearranged circuit the second H.F. valve tends to generate oscillations which are independent of the circuit tuning.

of high-frequency oscillations which are independent of the tuning of the circuits.

**Possible Methods of Preventing this Parasitic Oscillation**

Mr. J. H. Reyner, in the previously mentioned article on "Split Coil Methods of Neutrodyning,"

free from this trouble is to employ a "split condenser" in place of a split coil. Such a circuit is shown in Fig. 6. This, however, necessitates the use of double variable condensers which vary together in exactly the same ratio. With this type of circuit it should be possible to prevent the generation of parasitic oscillations.

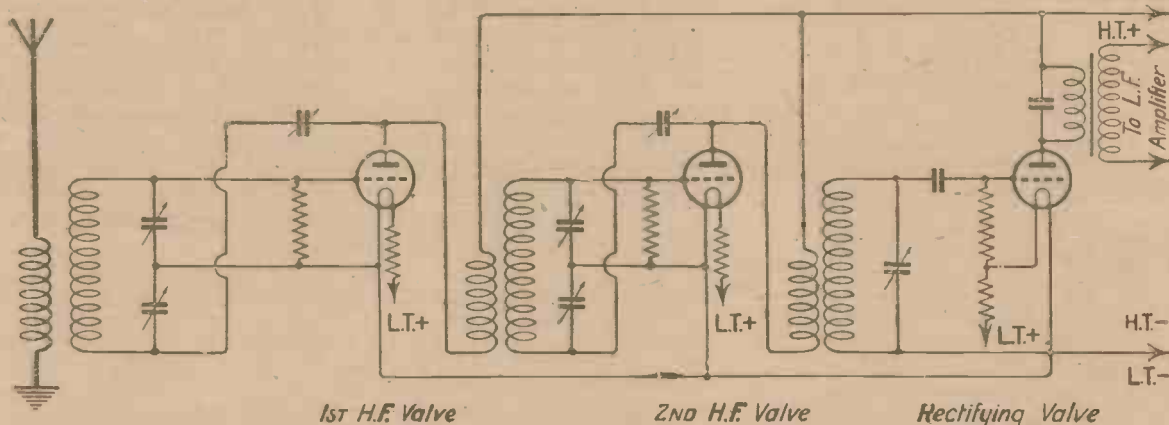

Fig. 6.—A type of neutrodyne circuit in which a double variable condenser is used in lieu of a split coil.

has suggested some methods for checking this parasitic oscillation.

Another method which has been used with success is the introduction of small high-frequency chokes in the grid leads on the anode side of the grid condensers. If these are of suitable value, depending on the type of coils and valve used, the oscillation can be completely prevented.

Another method which suggests itself as being

**An Interesting Fact**

An interesting point concerning this parasitic oscillation is that in quite a normal circuit, a thermo-milliammeter connected direct in the grid circuit may show a current of as much as about 30 to 40 milliamperes. Thus we can see why the circuit becomes dead when this takes place.

**Frequency of the Oscillation**

The frequency of the oscillation can be roughly determined by coupling a calibrated "trap circuit" to some part of the receiver. The trap circuit need only consist of an ordinary variable condenser and a loop of wire about 9 ins. or 1 ft. in diameter. When this circuit is tuned in to the oscillation, the usual characteristic click will be heard.



The Dimic Coil made by McMichael, Ltd., is suitable for split coil neutrodyning circuits.

HAVE YOU SEEN  
 THE NEW  
**Wireless Weekly ?**  
 Price, 3d.



A QUESTION that is frequently put to one by friends wishing to construct a wireless receiver is, "What set will give me loud-speaker results on most British and Continental stations and yet have a minimum of tuning controls? If possible it should work on a frame aerial, as living in a flat it is difficult for me to put up an outside aerial."

To this, there is only one reply, "A superheterodyne."

The amateur wireless enthusiast who has not yet handled a super-

and, under average conditions, pick just that station which it is desired to receive.

**Not a Complicated Set**

Many constructors think that a superheterodyne receiver is a complicated set, difficult to build and handle. This, however, is not the case, notwithstanding the fact that seven or more valves may be employed. Neither need there be any fear that it is difficult to get going in the first place, for the experimental model of the set here de-

ingly selective, so much so that even with geared condensers tuning is very sharp.

The set to be described in the following article receives Union Radio, Madrid, on 373 metres, free of all interference from 2LO working within two miles. All the main B.B.C. and most of the relay stations have been received on the loud-speaker, as well as numerous Continental transmissions.

As a matter of interest, it was decided to try and see how many stations could be picked up, and

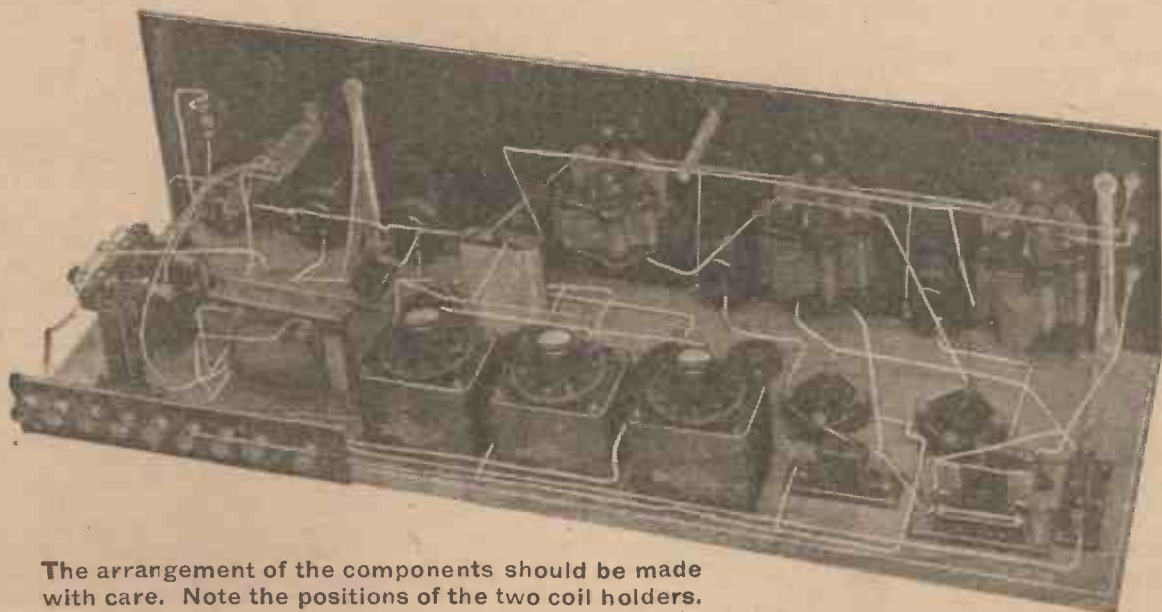

The arrangement of the components should be made with care. Note the positions of the two coil holders.

het., as it is usually called, has not experienced a form of reception that stands in a class by itself. With but two tuning controls it is possible to go from station to station on the loud-speaker with comparative ease, and it is possible to ignore the local transmission, even when within a mile or so,

scribed (which was designed after over 18 months' work on superheterodyne receivers) on being connected up immediately the constructional work was finished functioned satisfactorily. Such modifications as have been made in the finished receiver are of a minor nature. Further, it is exceed-

on an evening when conditions were normal, but not above the average, 39 separate stations were logged within an hour and a half.

**Sixty—Two Thousand Metres**

Among some of the special features this receiver displays is the fact that plug-in coils are used

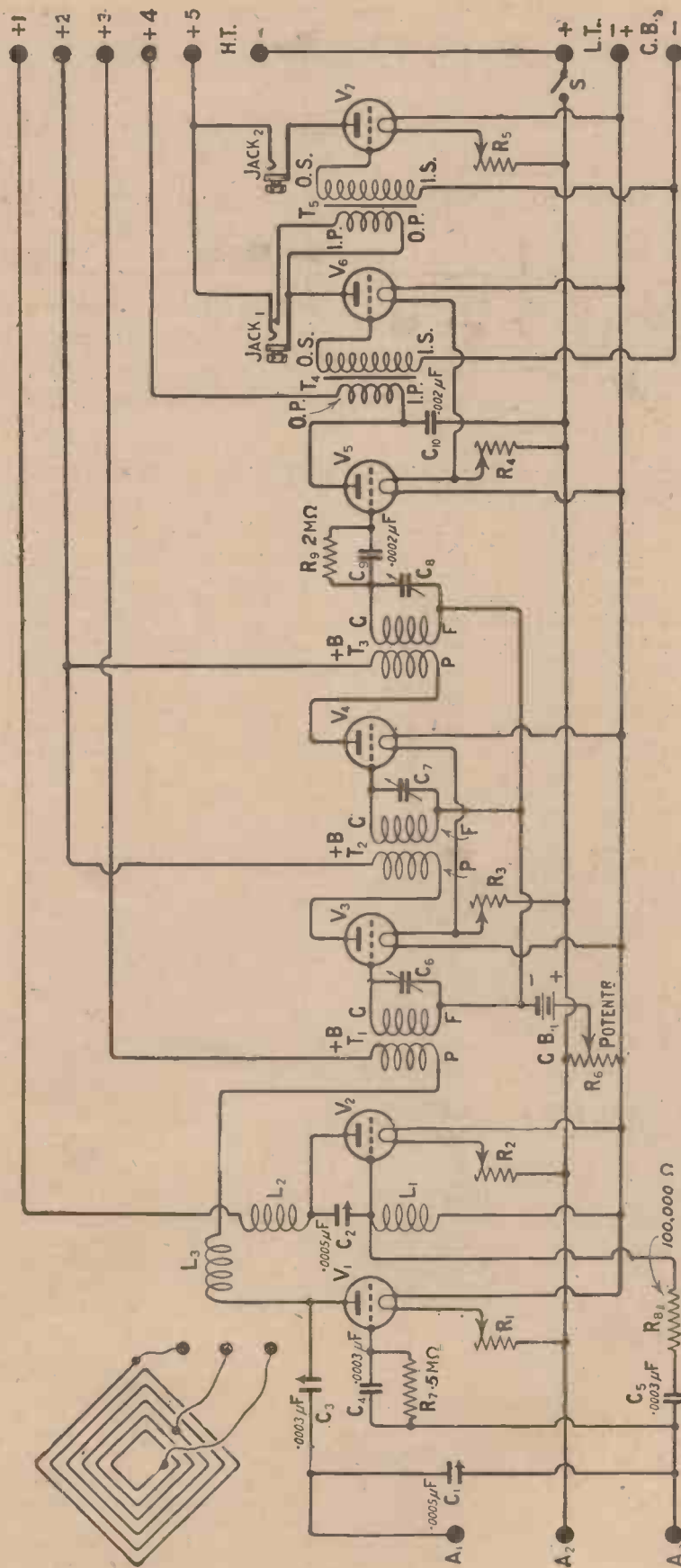

Fig. 1.—The theoretical circuit shows that several departures have been made from the usual arrangement.

for the oscillator, enabling various wavebands to be covered and Daventry and Radio Paris can be received. Also KDKA has been heard at 11.30 p.m. on 62 metres. This, of course, requires either a special frame or else a coupling unit to couple the set to an aerial. An indoor one will do very well.

The completed receiver is shown in its cabinet in the photographs, while other views are given showing the interior of the set both with and without coils and valves. Its appearance is most pleasing, while the disposition of the controls on the panel is neat and conducive to easy handling.

Three condenser dials are seen on the panel, but only two of these are for tuning, the other providing reaction in the frame aerial circuit. This is of the greatest value for the reception of distant stations, for a transmission that is only just audible in the loud-speaker may be brought up to good loud-speaking by means of this control.

Although seven valves are used the length of the panel is only 30 ins., and the views of the interior of the set show it to be compactly built yet without unnecessary crowding of any of the components.

**The Circuit Used**

To turn to the theoretical circuit shown in Fig. 1, it will be seen that it shows several distinct departures from the usual arrangement. The oscillator employs the Hartley-Reinartz system, two coils of equal size being placed in the grid and plate circuits and tuned by a variable condenser connected between plate and grid. These coils should not be coupled together, and it will be seen from the photographs and the baseboard lay-out shown in the wiring diagram (Fig. 4) that they have been placed at right angles. It was found that this gave the best results.

The usual pick-up coil for coupling the oscillator to the first detector is eliminated, the desired coupling being obtained straight from grid to grid by means of a condenser and fixed resistance in series as shown at C<sub>5</sub> and R<sub>8</sub> in the theoretical circuit. The values shown are those used by the author, but different values may be tried out. C<sub>5</sub> can be as large as .006 μF capacity and R<sub>8</sub> may vary within small limits with different valves.

**Reaction**

Reaction from the first detector valve is obtained by using a frame aerial with a centre tap. The outer ends go to plate and grid (terminals A<sub>1</sub> and A<sub>3</sub>), a variable condenser in the plate lead giving



The spacing of the wiring is shown in this photograph. Note that jacks other than those specified have been used as these were available when constructing the receiver.

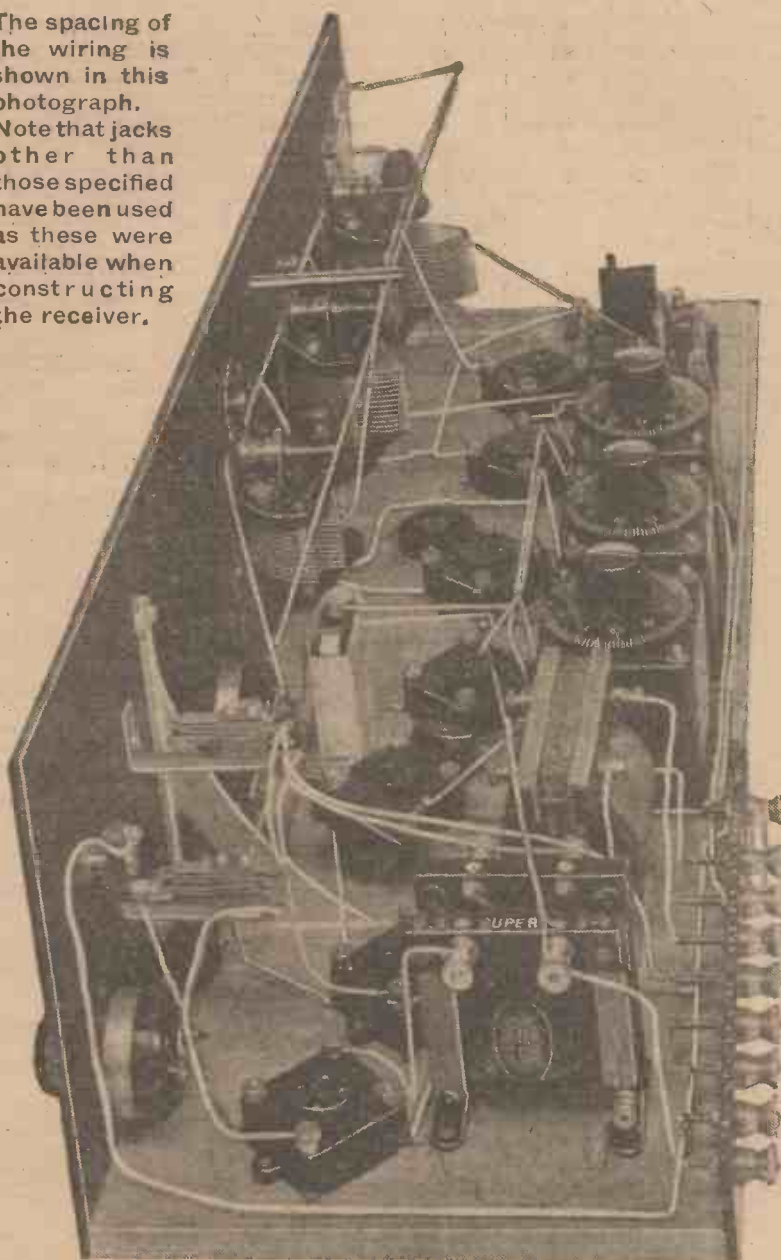

Since only two stages of inter-frequency amplification are used, that part of the receiver is exceptionally stable (depending, of course, to a certain extent on the valves employed therein and also on the valve that is used for the second detector), and it is therefore possible to use the maximum negative bias on the grids of these two valves. In order that this may be applied to the full a  $4\frac{1}{2}$  volt grid battery has been connected in the potentiometer circuit, so that a large negative bias may be applied as desired. In practice it is found that the best working point with the particular valves used by the writer is with the slider a quarter of the way round from the positive end.

#### Cutting out One L.F. for Searching

The second detector, which employs leaky grid condenser rectification, is followed by two stages of transformer coupled low frequency amplification; while the use of plugs and jacks allows either one or two stages of L.F. to be used as desired. This is particularly convenient when searching for distant transmissions, as they can be picked up with ease on the headphones with one stage. The other stage is then switched on and reception transferred to the loudspeaker, after which the transmission may be brought up to full strength.

It is also a desirable feature, in view of the fact that the receiver is so silent, that unless headphones are worn when first learning to handle it, it is frequently difficult to tell when the two tuning condensers are in the correct relation to each other, as the hiss that denotes this condition is so faint as to make detection in the loudspeaker difficult.

#### Common Controls

It will be seen that the detector valve and first stage of L.F. are controlled by one filament resistance, and it is therefore necessary to use valves of the same rating in these positions. The two stages of L.F. amplification employ the same high tension voltage, and, therefore, since these two valves are working under similar conditions a common grid bias tapping was found satisfactory. If the constructor desires to use a separate tapping for each valve he may do so, of course, but it has been the writer's aim to simplify this receiver as far as possible and reduce the number of auxiliary adjustments to a minimum.

reaction, and the centre tap is connected to L.T. +.

The small choke ( $L_3$ ) in the plate circuit of the first detector valve is included so as to enable reaction to be obtained at the higher frequencies. Down to about 150 metres the untuned primary of the transfer circuit serves as a choke, but below that it was found unsatisfactory.

#### Only Two Inter-frequency Stages

The intermediate frequency amplifier uses only two valves, and since the transformers employed are tunable no special filter is required. The fact that the inter-frequency transformers are tunable

is a most valuable feature, for two reasons: (1) If long wave interference is experienced from commercial stations working on a wavelength close to that to which the intermediate frequency amplifier is tuned, it is possible to eliminate this by readjusting the condensers, tuning the transformers and thus altering the wavelength; (2) it enables the filter and the two stages to be matched with accuracy, thus ensuring that maximum signal strength and selectivity is obtained. It may be mentioned here that it has been found that merely changing the valves in the inter-frequency amplifier is sufficient to throw the stages out of balance.

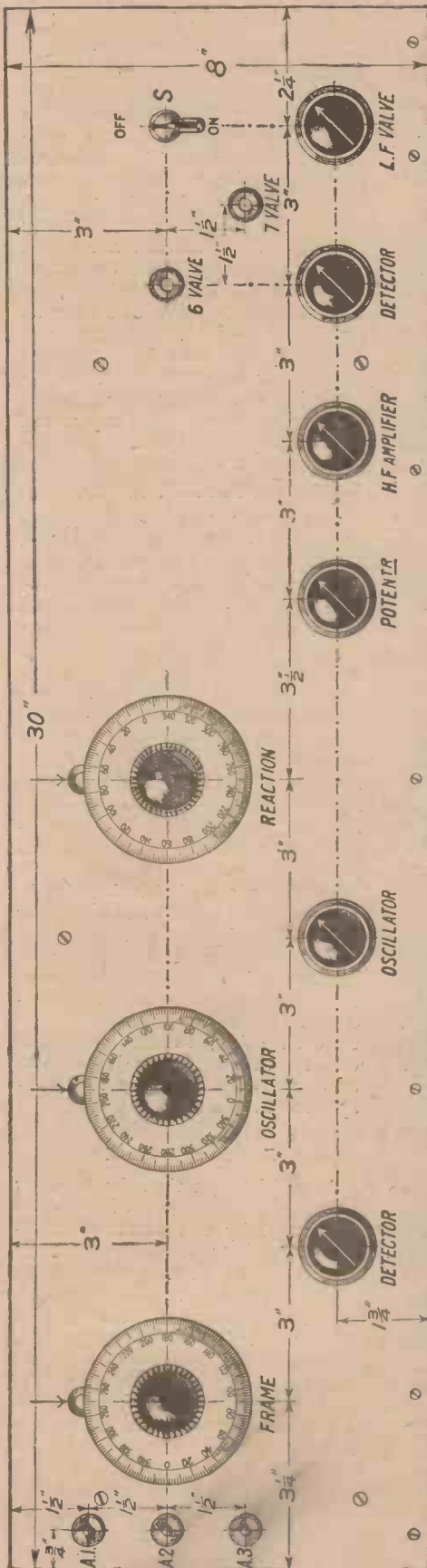

Fig. 2.—Marking out the panel controls will be made clear by reference to this diagram. Blue print No. 149a. 1/6 post free.

**Components Needed**

The components required to build this set are given below, although other makes, such as are advertised in this journal, may be substituted. It is important to note that if vital parts, such as the inter-frequency transformers, are substituted, it is impossible to expect to obtain the same results as those obtained by the author. It should also be noted that the three variable condensers are liable to hand-capacity effects owing to their position in the circuits, and therefore condensers with isolated dials are needed if the maximum ease of handling is to be obtained.

One Radion panel, 30 ins. by 8 ins. by 3/16 in., polished black (American Hard Rubber Co., Ltd.).

One cabinet for same (W. H. Agar).

One centre tap frame aerial (Beard and Fitch, Ltd.).

Two .0005  $\mu$ F geared condensers (Collinson Precision Screw Co., Ltd.).

One .0003  $\mu$ F geared condenser (Collinson Precision Screw Co., Ltd.).

Three Tropaformers (Rothermel Radio Corporation of Great Britain, Ltd.).

One L.F. transformer, Power type (Peto-Scott Co., Ltd.).

One second stage I.F. transformer (U.S. Radio Co., Ltd.).

Seven Clearertone valve holders (Benjamin Electric Ltd.).

Five 30 ohm Yesly filament rheostats (Engineering Supplies, Ltd.).

These have been used by the writer in order that different valves may be tried out; if, however, the constructor knows exactly what valves he intends to use, other suitable resistances may be obtained.

One Yesly potentiometer (Engineering Supplies, Ltd.).

Two baseboard mounting coil holders (Beard and Fitch, Ltd.).

One special H.F. choke (Burne-Jones and Co., Ltd.).

One grid condenser and leak unit with .0003  $\mu$ F condenser and 100,000 ohm resistance (L. McMichael, Ltd.).

One .0003  $\mu$ F fixed condenser (Dubilier Condenser Co., Ltd.).

One .5 megohm leak (Dubilier Condenser Co., Ltd.).

One grid condenser and leak combined .0002  $\mu$ F and 2 M $\Omega$  (Watmel Wireless Co.).

Two double circuit jacks (Igranic Elec. Co., Ltd.).

Two plugs (Igranic Elec. Co., Ltd.).

One .002  $\mu$ F fixed condenser (Dubilier Condenser Co., Ltd.).

One on-off snap switch.

Two panel brackets (Burne-Jones and Co., Ltd.).

Three large lacquered brass terminals (Burne-Jones and Co., Ltd.).

Nine nickelled W.O. pattern terminals (Burne-Jones and Co., Ltd.).

One strip ebonite, 10 in. by 2 in. by 3-16 in., for terminal strip.

Quantity tinned square copper wire and Glazite for connections.

One 4 1/2 volt dry cell.

Packet of Radio Press Panel transfers.

**The Construction**

The first stage in the construction of this receiver is to prepare the panel, and this may be done by means of the panel layout shown in Fig. 2, which gives all the dimensions necessary for determining the positions of the various components mounted on it. Care should be taken if guaranteed ebonite is not used to ensure that the panel be free from all possibility of surface leakage either on the back or front.

Having drilled the panel, mount the terminals, rheostats, potentiometer, jacks, switch and angle brackets, and fasten the panel to the baseboard by means of No. 3 1/2 in. countersunk brass wood screws. Next fix on the baseboard the seven valve holders, the two coil holders, grid condenser, and the unit holding the coupling condenser and resistance. The

positions for these components may be obtained from Fig. 4, which is drawn exactly to scale and will therefore serve as an accurate guide to positions of all those parts mounted on the baseboard. Determine the positions of the inter-frequency transformers and place them on the board, drawing an outline round them with a pencil. Do the same with the two low frequency transformers. This will then show clearly where to run certain wires that go round or between them and enable these to be put in position without difficulty

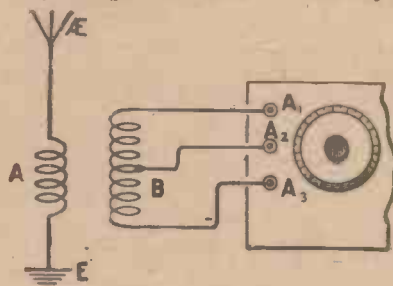

Fig. 3.—For long wave work loose coupling to an outside aerial is used.

or risk of fouling them. The transformers are then put into place after these particular connections have been made.

**Components which are Mounted Later**

Similarly, the variable condensers which have not yet been mounted on the panel will be fixed thereto after certain wires have been placed in position. These several connections should therefore be made next. They are the low tension leads from the filament resistances to the valve holders, and also the common negative bus-bar that runs along the back edge of the baseboard.

After this is done the three variable condensers are fixed to the panel and the three shielding plates joined together and to L.T. positive and the two remaining connections from the two filament resistances made to the L.T. bus-bar. The potentiometer should also be connected up, the left-hand tag going to the positive bus-bar and the right hand to the negative. The centre tag is for the slider and is connected later. The leads to the three condensers, the two coil holders, the grid condenser, coupling condenser and resistance may next be completed.

The lead from the terminal A<sub>1</sub> to the reaction condenser C<sub>3</sub> is rather long, and it has therefore been supported by a piece of 3/16 in. ebonite rod. This is drilled and

tapped 4 B.A. at one end, so that it stands out at right angles to the panel. The other end has a small hole drilled in it through which the wire is passed.

**The H.F. Choke**

Before mounting the inter-frequency transformers fix the small choke, which is connected in the plate circuit of the detector valve so as to allow reaction to be obtained at the high frequencies. This consists of about 150 turns of 32 S.W.G. enamel or silk insulated copper wire, wound into a slot cut in a circular ebonite bobbin, 2 ins. in diameter, the slot being about 1/2 in. deep and 1/8 in. wide. A hundred turns wound in a single layer on a 2 in. ebonite or dry cardboard former will do, but care must be taken in mounting it to see that it does not foul the moving plates of the oscillator condenser.

The three inter-frequency transformers may now be fastened to the baseboard and connected into circuit. A number of short leads with brass spade tags soldered on the ends will be found useful at this stage, as these fit under the terminals and simplify the wiring. Next come the two stages of L.F. amplification with the various leads going to the jacks, after which the several H.T. positive leads may be brought to their respective terminals. Any connections not completed may now be finished off.

**Check the Wiring**

Having completed the wiring carefully check all the connections

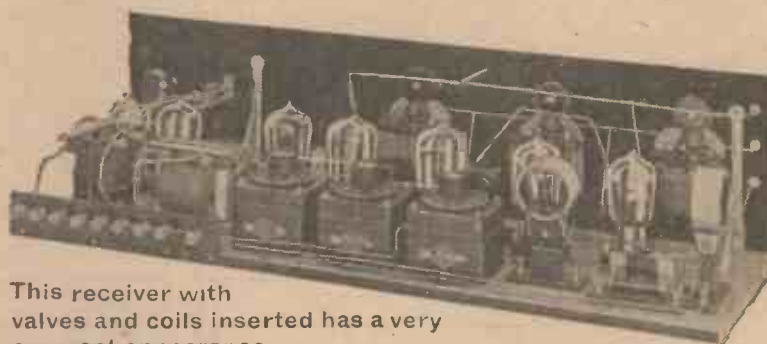

This receiver with valves and coils inserted has a very compact appearance.

and then test out the L.T. and H.T. circuits. The set may now be tested on the local station. Two No. 50 coils should be plugged in the holders (or two Gambrell B's), the outer ends of the frame aerial connected to terminals A<sub>1</sub> and A<sub>3</sub>, the centre tap going to A<sub>2</sub>. A common H.T. value of 60 volts will be suitable for this preliminary test, and the reaction condenser should be set at zero.

**Using the Frame Aerial**

The frame should be pointed in the direction of the local station and the condensers on the tropaformers each set to the same value. The local station may now be searched for by rotating the two tuning condensers till it is heard, the potentiometer being adjusted so that the slider is near the positive end of the winding. The searching should be done slowly if the station is at any appreciable distance, as the tuning, on the oscillator condenser in particular, is exceedingly sharp. When the station is heard it should be tuned in to its loudest and the potentiometer should be adjusted to see that it gives the correct control. Next adjust the condensers on the tropaformers till the maximum signal strength is obtained. During this procedure it will probably be necessary to adjust the oscillator condenser slightly and try different settings of the inter-frequency tuning condensers to see at what setting of these condensers maximum amplification is obtained.

**Balancing the Intermediate Transformers**

On the writer's receiver the settings are 75, 62 and 60 for the first, second and third transformers respectively, and this also gives a wavelength that is remarkably free from long wave interference in his locality. Long wave interference may be recognised by the fact that Morse is heard whenever a carrier is picked up, the pitch changing as the oscillator condenser is adjusted.

With regard to the valves used, the two most important ones are those for the two intermediate stages, and two P.M. 4 valves have been found best up to the present. D.E. 5's are also satisfactory, and no doubt the B. 4 would also suit, and other valves of this type. For the first detector, various valves have been used with equally good results, and this does not appear to be at all critical. Providing a 60

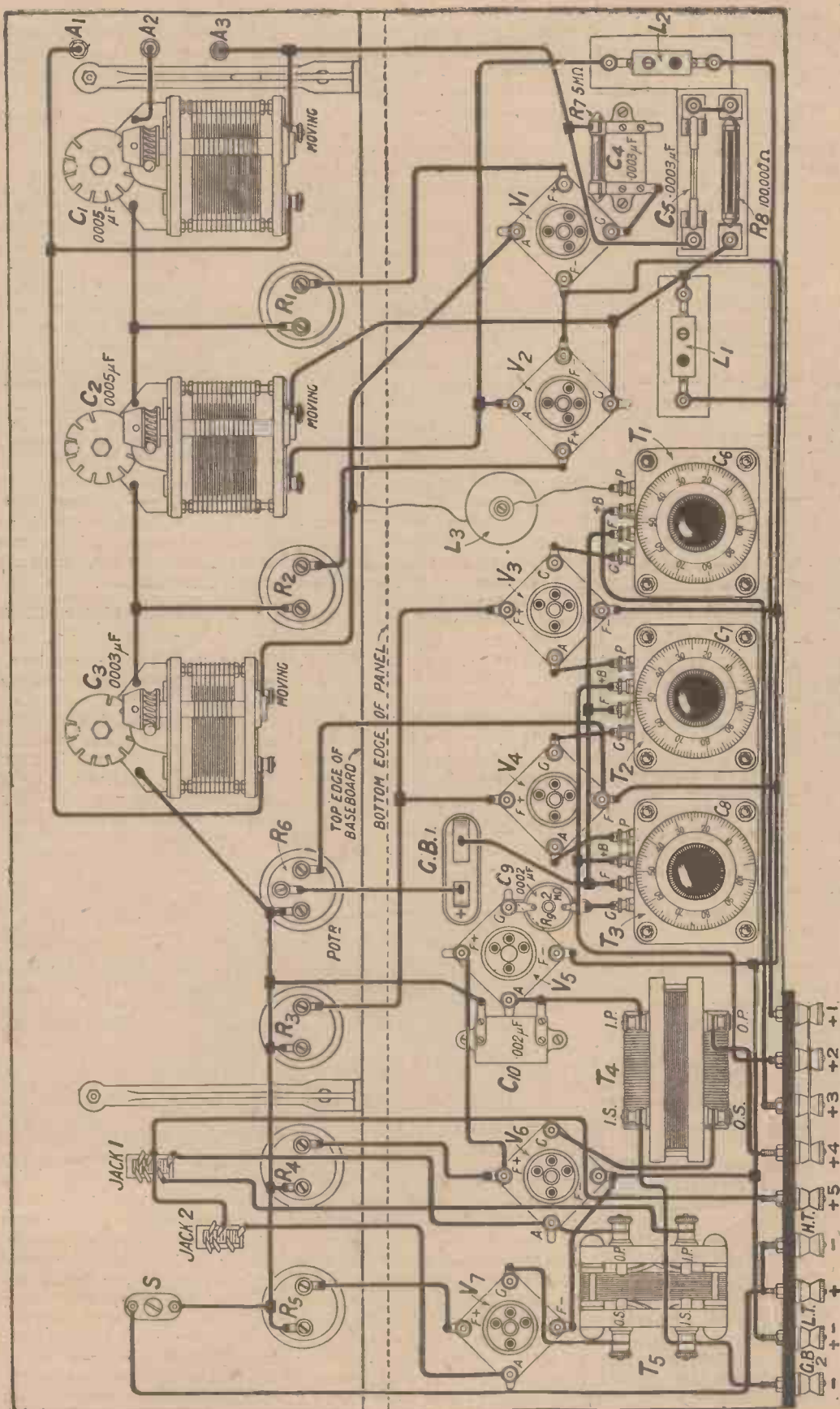

Fig 4.—The back-of-panel layout can be followed by reference to this diagram. Blue print No. 149b, may be obtained for 1/6 post free.

ohm filament resistance is used a 60 type valve may be employed. A D.E.5 b is excellent as second detector, and two D.E.5 type valves for the L.F. stages are generally used. A small power valve is found best for the oscillator, while on 60 metres it may be necessary to try different valves to see which will oscillate down to the lowest reading on the condenser.

**A Hint for Distance Work**

It should be noted that for distant reception it may be found an advantage not to have the oscillator valve turned full on, a marked improvement being obtained with a D.E.5 when the rheostat was only turned two-thirds on. This also applies to the reception of 5XX and Radio Paris. If the inter-frequency amplifier does not oscillate at any setting of the potentiometer this should be set at the point where the greatest volume is

whistles will be heard. Reaction should be reduced before searching for another station, or as soon as the frame aerial circuit is detuned, the first detector will oscillate. A little practice will soon show the best procedure for tuning in distant stations, and the directional properties of the frame will frequently assist in cutting out interference.

**Final Adjustments**

Having tuned in a distant station the final adjustments to the tropa-formers should be made. Transfer the set to the loud-speaker if the transmission is strong enough and then make very small alterations in the tuning of the condensers which are on the inter-frequency transformers till the loudest signals are obtained. It may be necessary in the interests of quality and silence of background to detune one of the stages slightly. Once

a 7-turn coil with a centre tap will replace the frame, this being loosely coupled to a 2-turn coil in the aerial.

**Long Wave Reception**

For the reception of 5XX and Radio Paris two Gambrell G coils were used in the oscillator. It is important that these two coils be matched and therefore two coils of different makes (even if of the same nominal size) should not be used. The oscillator filament, when using a D.E.5 valve, should not be turned on more than half-way with a 30 ohm resistance.

As a frame for long wave work would require to be specially made, a centre tap coil, such as a Gambrell G, was used instead, loosely coupled to a coil in the outside aerial. The method of connecting up is shown in Fig. 3 and is similar to that used for short wave work, except for the sizes of the coils.

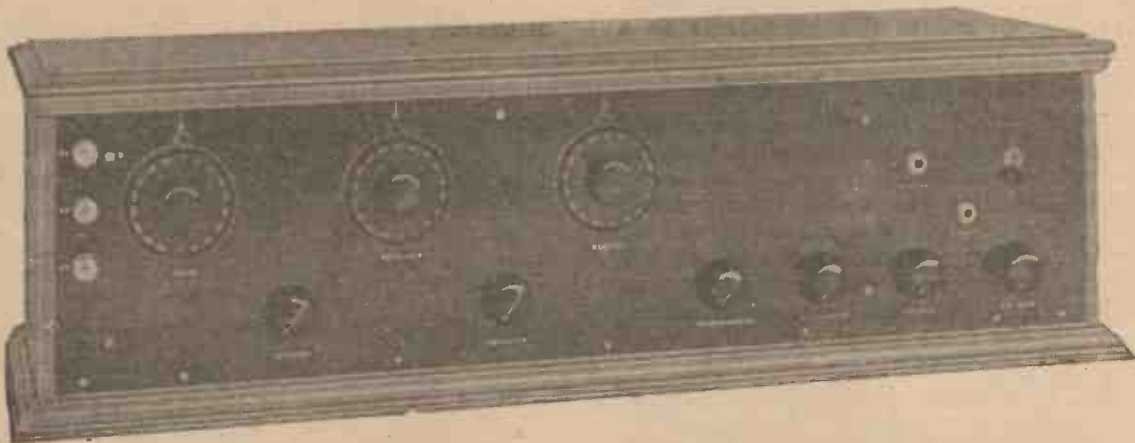

The finished receiver presents a handsome appearance, the disposition of the controls being conducive to easy handling.

obtained. If oscillation occurs at a particular setting it should be adjusted so that the inter-frequency stages are just off the oscillating point.

Distant stations may now be searched for. Turn the two tuning condensers together, in the same direction, and it will be found that if they are in the correct relation to each other a slight hissing sound will be heard.

**The Use of Reaction**

If a carrier is picked up it will be heard as a louder hiss and tuning will be found to be very sharp. When a distant station is being received it will be found that increasing the reaction condenser will bring it up greatly in strength, but if it is increased too far the first detector will go into oscillation and nothing but a series of heterodyne and reheterodyne

set these need not be touched again unless severe long wave interference is experienced.

Correct values of H.T. may now be applied to the various valves and the following is a guide.

H.T.1 oscillator—60 volts; for short waves 100 volts may be required.

H.T.2 intermediates—60-80 volts.

H.T.3 1st detector—40 volts.

H.T.4 second detector—60-100 volts.

H.T.5 2 L.F.—120 volts.

Suitable grid bias should also be applied to the two L.F. valves, *i.e.*, about 6-9 volts.

**Short Wave Work**

For those who wish to work on the 60-metre wave two 7-turn coils will be found satisfactory for L<sub>1</sub> and L<sub>2</sub>, and it will be preferable to use an outside aerial coupled very loosely rather than a frame. In this case

**Some Stations Received**

Testing on a frame aerial situated about 1½ to 2 miles from 2LO over 25 stations were received in the course of a short period during the afternoon, some 10 to 15 of these being at good loud-speaker strength. At night no fewer than 39 stations were picked up. Among these were Kiel, Eskilatuna, Elberfeld, Brussels, Malmo, Hanover, Berne, Radio Lyons, Marseilles, Cardiff, Union Radio Madrid, Manchester, Oslo, Bournemouth, Dublin, Hamburg, Newcastle, Münster, Breslau, Glasgow, Belfast, Radio Toulouse, Ecole Superieure, Frankfurt, Birmingham, Munich, Aberdeen, Berlin and Zurich.

Most of these were received at excellent strength on the loud-speaker. Numerous other stations have been received at varying strength in the phones with one stage of L.F.

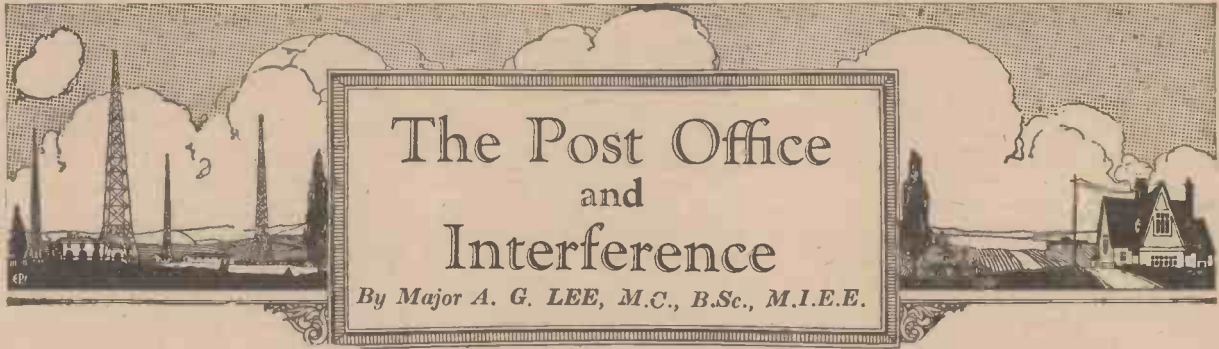

*The questions of interference are acute at the present time and this article from the pen of the Chief of the Post Office Radio Section throws a light on the subject.*



HE Post Office, as one of the largest users of wireless in this country, is from time to time blamed for producing interference to broadcast listeners. It may, therefore, be of interest if I give an account of what the Post Office has done, and is doing, to reduce this interference to a minimum.

**Are the Complaints Justified**

In the first place, it must not be imagined that all the complaints seen in the papers are justified. The average broadcast listener cannot read Morse, and cannot identify the station which causes trouble. Many of the complaints about the North Foreland spark station, for example, are attributable to Boulogne or to ships working in the Channel. Again, there is a personal incident which points the same moral. I met a friend

whom I had not seen for some time, and he remarked, "I wish you would put a stop to those harmonics from Northolt." Further questioning elicited the fact that his reception of 2LO had been entirely spoiled by Morse which he could not read, but which he thought was Northolt. I enquired where he was living, and found that it was at a point about seven miles from Northolt,

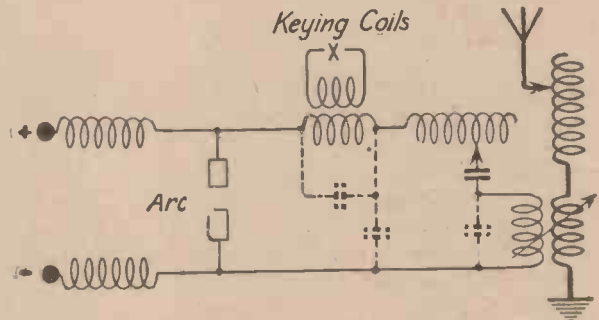

Fig. 1.—A diagram of the coupled circuit at Leafield. The condensers for shunting harmonics are shown dotted.

where a certain prominent amateur short-wave transmitter also resided, and it was quite evident whence the interfering Morse had emanated. At this particular time I knew that good reception of 2LO was being obtained within 200 yards of the Northolt station.

However, the Post Office has not been idle in the matter of reducing interference.

**Arc Interference**

The first station which was tackled was Stonehaven, which contained a Poulsen arc. Then followed Northolt. Both these stations had the arcs converted to coupled circuit working in the early summer of 1922. Then followed Leafield, where the coupled circuit was brought into operation in March, 1924. This entailed a considerable amount of work, which was retarded by the ordinary commercial operations of the stations. It is, perhaps, difficult to realise that in a powerful transmitting station it is impossible to work with any metal in the vicinity of the transmitter without drawing enormous sparks from the metal to the hands, for example. All metal objects



The primary inductance coil of the Rugby Station.

become charged, and the trick of lighting a cigarette from a spark drawn from a piece of metal is often shown to astonished visitors at these stations.

**Harmonics and "Mush"**

It may be useful at this point to explain how a coupled circuit reduces harmonics and "mush." Nearly all wireless generators, such as arcs and valves, produce harmonics, because the wave form of the current has irregularities. In the case of the arc, the current is interrupted for a

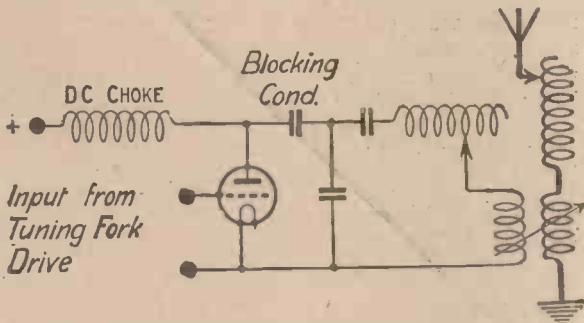

Fig. 2.—A coupled circuit for eliminating harmonics from valve transmitters.

very brief interval when the arc goes out once each cycle. "Mush" is due to another cause, the fact that the frequency generated by the arc is not perfectly steady, which produces an infinite series of harmonics. In both cases the aerial, in addition to being in resonance on its fundamental frequency, can also resonate on harmonics of that frequency. The aerial is somewhat similar to a violin string, which when bowed in a particular way can be made to give off strong harmonic vibrations.

**Coupled Circuits**

A diagram of the coupled circuit is given in Fig. 1. The primary circuit has its inductance and capacity concentrated, instead of being distributed, as it is in an aerial, along the length of the wire. In these circumstances the primary circuit, therefore, acts as an effective stopper to prevent the harmonics reaching the aerial. If they do get to the aerial in spite of these precautions, then they will be radiated, because, as already stated, the aerial will resonate to certain harmonics.

Now at Leafield, after the coupled circuit had been completed, we found that while most of the harmonics had disappeared, there were still some on the broadcasting band of frequencies. A search for the cause disclosed the fact that the keying coils in the primary circuit were too near the aerial tuning inductance. Although they were 5 ft. apart, this gave sufficient capacity coupling for these harmonics to get into the aerial without passing through the effective stopper we had arranged in the form of a condenser across the coupling coil. This difficulty was overcome by placing condensers, shown dotted in Fig. 1, whose function it is to keep the harmonic potential of the keying coils as low as possible.

**Radiation from the Primary Circuit**

The next step was to stop radiation from the primary circuit; this was done by enclosing the whole building in a network or screen of copper wires. By this time it became possible to receive broadcasting in the grounds of the station itself, and, in fact, practically all the staff now have broadcasting receivers.

There was, however, still one town about six miles away which complained of trouble. This was eventually traced to the telephone wires, which carried the harmonics from the wireless station into this particular town. Air-core chokes placed in the telephone wires soon solved that particular trouble.

The condensers used for the primary circuit have a capacity of .025  $\mu$ F, and are designed to stand a working voltage of 80,000 volts. They consist of metal plates supported by porcelain insulators in tanks filled with oil.

**Frequency Variations**

The primary inductance is made of strip copper, pancake wound, and is arranged as a variometer for tuning purposes. It was found that a coupled arc is liable to develop sudden frequency changes unless the tuning fulfils certain conditions, so that fine tuning by means of a variometer is essential. With these conditions fulfilled, there has been no trouble due to these frequency changes.

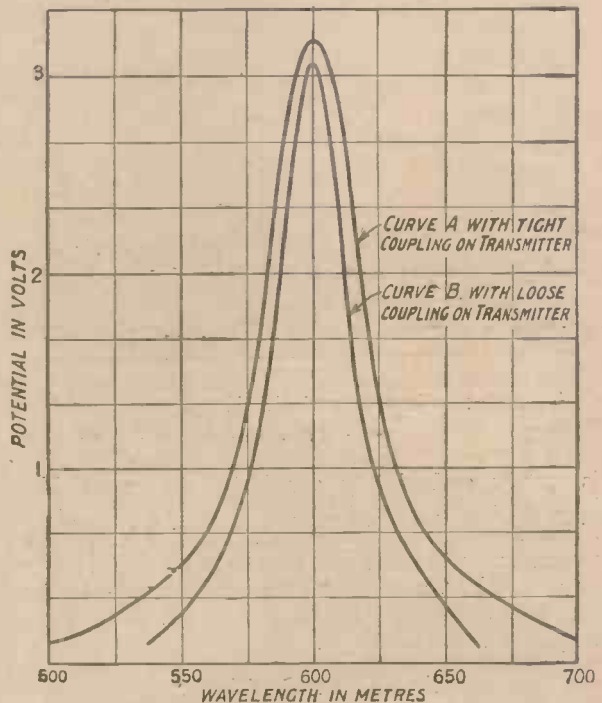

Fig. 3.—Resonance curves of the radiation from a spark station measured at a short distance from the station.

In addition to the sudden jumps in frequency, an arc is liable to frequency variation due to the swinging of the aerial in a high wind. This has been reduced by careful tensioning of the aerial wires, so that Leafield is now one of the

most constant frequency stations in existence. It also has the distinction of having the largest powered arc, working on coupled circuit, in the world.

#### Valve Harmonic Interference

The next subject which received attention was the elimination of harmonics from valve transmitters. It must not be supposed that valve transmitters are immune from this particular trouble. On the contrary, in their raw undiluted state the harmonics are far more powerful than those from an arc station. Coupled circuits are also employed to cure this trouble, and a diagram illustrating the circuit employed is given in Fig. 2. The valve transmitter is used as an amplifier, which is driven by a harmonic from a tuning fork oscillator. This is an example of one of the beneficent uses of a harmonic. The wireless frequency which is sent out from our valve stations at Northolt, Devizes and Rugby



These condensors at the Rugby Station have a total capacity of  $1.3 \mu\text{F}$ , and are mica-insulated.

is purely and simply a selected and amplified harmonic of a tuning fork which is oscillating at about 2,000 cycles per second. All the harmonics which are not wanted are filtered out and the circuit in Fig. 2 performs the function of filtering out the additional harmonics which the power amplifier itself develops.

#### A Master Oscillator

As will be seen, it is slightly different from the coupled arc circuit, because, being driven by a master oscillator, it allows some changes to be made. One of the important changes made is that the anode tapping point is across a condenser instead of across an inductance. This anode tap condenser acts as a heavy shunt for the harmonics, which are thus prevented from getting into the aerial circuit. Even with the enormous power

employed in the valve transmitter at Rugby, there is no trouble due to the harmonics.

#### The Condensers and Inductances at Rugby

One of the photographs shows the condensers used for the primary circuit at Rugby. They are of mica insulation, and have a total capacity of  $1.3 \mu\text{F}$ . It will be seen that they are of colossal size compared with the miniature condensers used in receivers. Another photograph shows the primary inductance coil. The heavy cable carried by the spiders contains 6,561 wires, each separately insulated with enamel and silk or cotton. The two turns on the spider at the left-hand side are part of the aerial circuit and form the coupling between the primary and secondary circuits, and it is of interest to note that on full power 500 kilowatts will be passing through the 4 or 5 ft. of space between the primary coil and these two turns. The woodwork forming the spiders is of "American whitewood," which has a lower power loss than ebonite.

#### Spark Stations

A further point of interest is the work which has been done in reducing the trouble caused to broadcasting by Post Office spark stations. The interference in this case is not due to harmonics, but is a direct shock excitation of the broadcast listener's aerial circuit. The spark method of generating wireless energy is inherently an impulsive method, and all that can be done, short of its abolition, is to arrange for a sufficiently low decrement in the transmitter, either by low-resistance circuits, or by a multiplicity of loose coupled circuits. Fig. 3 shows the effect of loosening the coupling on the resonance curve of a spark station. It will be seen that the loose coupling gives a more narrow resonance curve, with consequently less interference to broadcast listeners. Interpos-

ing an intermediate circuit between the primary and secondary produces a similar effect in making the resonance curve of the station more narrow, and this arrangement has been adopted at the North Foreland wireless station. The spark itself always produces heavy damping. Widening the resonance curve, and loose coupling, combined with a low-resistance aerial system, helps to prevent this damping effort being transferred from the primary to the oscillations being radiated from the aerial.

It should not be forgotten by those living near the coast that wireless is essential to shipping for use in connection with saving life at sea, and the use of the spark system is sanctioned by international convention. It will be some time, in view of the capital outlay involved, before all the spark sets on board ship can be replaced by tonic train valve sets.



# Laying Out Your Receiving Set

By  
**A. JOHNSON-RANDALL**

*Laying out a receiving set is not a simple matter and this article shows in a lucid manner what points need consideration.*

**T**O design a wireless set sounds a very simple matter, and yet the whole subject of set design is fraught with difficulty. I am not speaking of evolving a new circuit, and of turning it into a practical receiver—that is a job

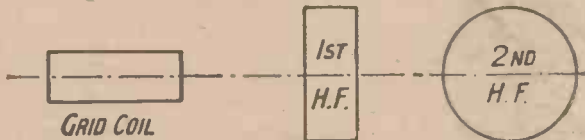

Fig. 1.—An arrangement of coils to prevent interaction between the magnetic fields.

for the expert—but of taking one of the many circuits published from time to time in Radio Press journals, and making it up into a neat and efficient set which will give the same results as those obtained by the originator of the particular circuit chosen.

### The Chief Points to Consider

The chief points to be borne in mind when making up a set from a circuit are that, first,

the layout must be carefully thought out according to the type of circuit chosen, and secondly, the layout should be symmetrical in order to produce a completed receiver which will delight the eye. To combine these two points is a somewhat difficult matter, and the result is generally a compromise.

The general layout of the set must depend upon whether the circuit includes high-frequency amplification or whether it is a simple detector valve employing a stage or more of low-frequency magnification.



Fig. 2.—A popular method used to avoid coupling between the H.F. coils.

### High-Frequency Amplification

Dealing with the case of circuits employing H.F. amplification, I may say that from the point of view of both efficiency and appearance I personally prefer the American type of layout, utilising a loose baseboard. In this way it is possible to arrange all the valves and the inductances behind the panel, reserving the panel for the filament controls and variable condensers. The various battery terminals, together with those for the aerial and earth, can be mounted on a strip of ebonite screwed to the back of the baseboard. They are therefore in a convenient position for wiring, and the appearance of the set is not spoiled by a number of flexible leads trailing around the front of the panel. The variable condensers can be mounted in a straight row along the horizontal centre line of the panel, the filament controls being arranged in a symmetrical manner below them.

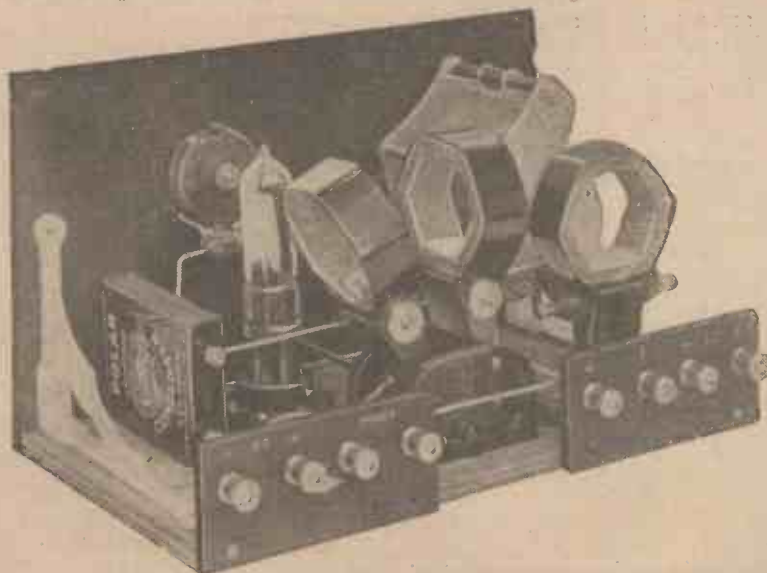

A compact receiver with the plug-in coils efficiently arranged.

**Switching**

Switching after the detector valve may be carried out with the aid of jacks, the insertion of the telephone or loud-speaker plug bringing the required valve into circuit.

I do not under any circumstances recommend any form of switching arrangement on the high-frequency side, since this method of control in nine cases out of every ten results in inefficient operation.

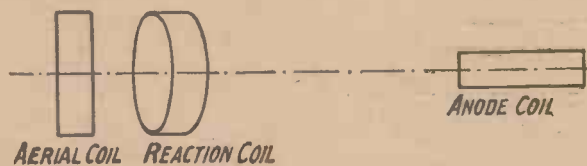

Fig. 3.—A satisfactory arrangement for reaction on to the aerial circuit.

In fact in the modern forms of neutrodyne circuits it would probably be quite impossible to stabilise a receiver employing such an arrangement.

**Large Inductances**

For a set in which the circuit chosen demands the use of large inductances it is necessary to choose a cabinet of such dimensions that the baseboard is at least 7-8 ins. deep. At the same time the length should be sufficient to permit adequate spacing if more than one stage of high-frequency amplification is desired, unless of course some form of screening is used. The depth of the baseboard is important since in the case of a shallow one a coil several inches in length may have to be placed very close to the metal endplate and vanes of a variable condenser, with the resulting loss of efficiency in the coil through the production of eddy currents.

**Practical Methods with H.F.**

In a receiver with two stages of H.F. amplification there are two practical ways of arranging inductances so that the interaction of their fields is a minimum. These are shown in Figs. 1 and 2.

The first method is comparatively simple, but somewhat difficult to arrange with certain types of coils designed to be mounted horizontally, since the third coil, it will be noted, is placed on end in a vertical position. The second method is very popular and can be used for any number of stages, but it should be remembered that there is no fixed angle which covers all types of coil, the position of minimum coupling depending upon the dimensions of the coil. Provided there is ample space on the baseboard the final positions can be determined experimentally by moving the coils and noting the effect upon the working of the set.

**Neutrodyne Condensers**

For neutrodyne circuits I should like to see a neutrodyne condenser suitable for baseboard mounting, but with a long ebonite adjusting rod of a design which permits the rod to be withdrawn from the condenser when the correct adjustment has been found. Most of the existing condensers have to be mounted on the front panel with the consequent long leads rendered necessary by their distance from the coils.

Assuming suitable baseboard mounting neutrodyne condensers—and there probably will be a number of these very shortly owing to the increasing popularity of neutrodyne receivers—the valves themselves can be placed just in front and between the coils, the battery terminals being arranged along the edge of the baseboard at the back of the coils. With the valves arranged in this manner the leads to the filament rheostats will be short and well clear of all other wiring.

**Tuned Anode with Reaction**

I have so far only considered the lay-out of the most difficult type of set, but equal precautions should be taken in the case of receivers employing only one stage of H.F. amplification. Take for example a simple tuned anode circuit with reaction applied to the aerial circuit. The inductances in this case should be arranged so that there is a minimum coupling between the aerial and

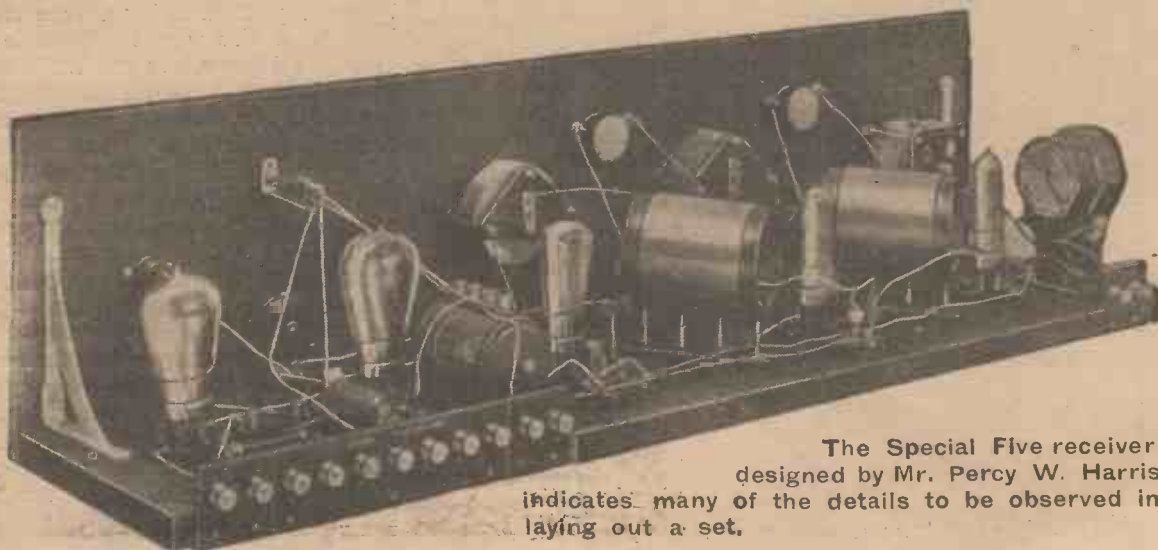

The Special Five receiver designed by Mr. Percy W. Harris indicates many of the details to be observed in laying out a set.

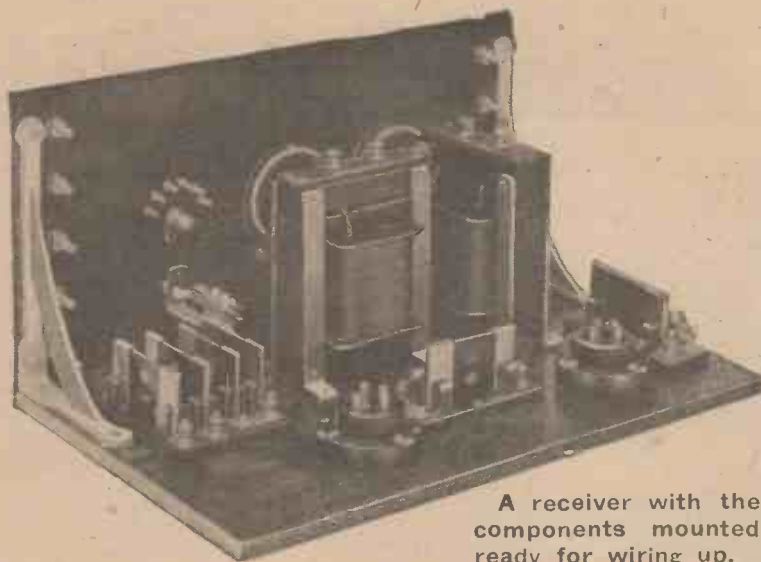

A receiver with the components mounted ready for wiring up.

anode coils. One good arrangement is shown in Fig. 3.

**A Good Plan**

When designing a receiver of any type the best plan to adopt in planning a suitable layout is to obtain a large sheet of paper to represent the panel, at present, of course, of unknown size, and another sheet to represent the baseboard.

Choose the components which you desire to use, and having obtained them lay them out on the sheets in the approximate positions which are to be adopted for the final arrangement. Find by direct measurement the amount of space required, allowing the requisite clearance all round, and you have the size of panel and baseboard required. In order to reduce cost a compromise may be necessary, therefore it is a sound principle to secure lists of stock sizes of cabinets and panels, choosing from these lists a cabinet and panel of dimensions approximating to the ideal. Of course, if expense is no object a specially

cut panel together with a hand-finished non-stock size cabinet is very attractive.

**The Low-frequency Side**

On the low-frequency side of a receiver difficulties in layout are not so numerous, but with transformer or choke coupling spacing still remains necessary. That is, of course, when two stages are employed. It is not a good plan to place two transformers in very close proximity in all cases, although with some makes no ill effects are noticeable. In any case the safest scheme is to place them with their cores at right angles, but it should be borne in mind that there are other factors which affect stability in L.F. amplifiers. The mere fact of two transformers being carefully arranged on the baseboard does not always

ensure stability in operation. These other factors cannot be dealt with in an article of this nature, and the constructor should be careful to purchase components of the highest quality and to choose a pair recommended by the makers as being suitable for the type of amplifier he wishes to construct.

**Plug and Jack Switching**

Where plug and jack switching is employed care should be taken to allow a good clearance in the neighbourhood of the jacks, since in some cases soldering the leads to the jack contacts can become a very difficult procedure. Another point to note is that any components or leads in the vicinity of the valve holders should be placed in position with the valve to be used inserted in the holder. Failure to observe this precaution may mean an alteration in layout after the set has been wired up.

Tests being made at the Bureau of Standards in Washington to determine the best types of tuning coils for receiving sets.



## Radio in Other Lands

**T**HE new observatory which is being constructed at Mont Saleve is 1,500 metres above the sea level on the Swiss border, near to Geneva. This observatory is to be fitted with an exceedingly high power transmitter and weather reports will be broadcast.

On a site close to the famous Koenig-wusterhausen station what is claimed by Germany to be the highest aerial in the world has been built, although we do not know upon what grounds they have bettered the Eiffel Tower. This aerial is 755 feet in height, and an additional mast of about 178 feet has been erected and added for the purpose of short wave transmissions. At present it is used only for testing purposes carried out by the Doeberitz station; but it is expected that very shortly it will be used for its legitimate purpose. In Koenigswusterhausen itself a new transmitter with a power of 20 kilowatts has been ready for some time, and when this high power is used in conjunction with the wavelength of 1,300 metres it will still further enlarge the range which this station has been able to encompass.

In the Arctic Sea it would appear that news bulletins and Press reports are received more clearly than any other transmissions. Captain Larsen, of the whaling vessel *Falk*, has recently been cruising in the Arctic Seas near the South Shetland Islands. For some time they had been unable to get into communication with any country whatsoever, and things were getting monotonous, but afterwards they were able to pick up various broadcasting stations in all parts of the world, and items which were most clearly heard were the general news bulletins. New York and San Francisco both came through well, but the German station of Nauen was reported as the best and most

regular. This station, it will be remembered, does not transmit concerts, only time signals and Press reports. For these transmissions Nauen uses a wavelength of 3,000 metres and a power of 50 kilowatts.

To organise broadcasting in India is to organise it for a continent containing people and races as different from each other as are the people and races of Europe. Then, again, the programmes must vary not only in language but also in taste and material. Will the

chance that the wireless medium may perform wonders in reconciling East and West.

It is probable that India and Ceylon will be equipped with ten broadcasting stations within the next five years, and both English and Indian capital will be invested. Already application has been made to the Indian Government. At present India possesses only two small private broadcasting stations, at Calcutta and Bombay, and the first steps under the new scheme will be to convert those into standard stations, and then to erect one at Madras. Local relay stations will be set up to serve the different territories.

In Paris the abolition of the code by means of which the Eiffel Tower still transmits time signals at 10.45 a.m. and 10.45 p.m. was recommended by the Commission de l'Heure at its recent meeting. The Commission recommended the adoption of the International Code, with this difference, that in place of the last three dashes, each of the three minutes shall end with the six dot seconds as transmitted by 2LO.

Considerable interest is being shown by the more technical members of the American broadcast listeners in the Daventry station, and it is the hope of all these enthusiasts to pick up the signals from Daventry regularly during this year. With this in view amateurs have been busily engaged in the construction of sets that will reach the frequency of 5XX; for, of course, none of the existing receivers in the United

States is constructed for a frequency lower than 500 kilocycles. The *Radio Informer* states that this enterprise of American radio enthusiasts should do much to cement the friendship between the two nations, and should also educate the American public to understand the English accent.

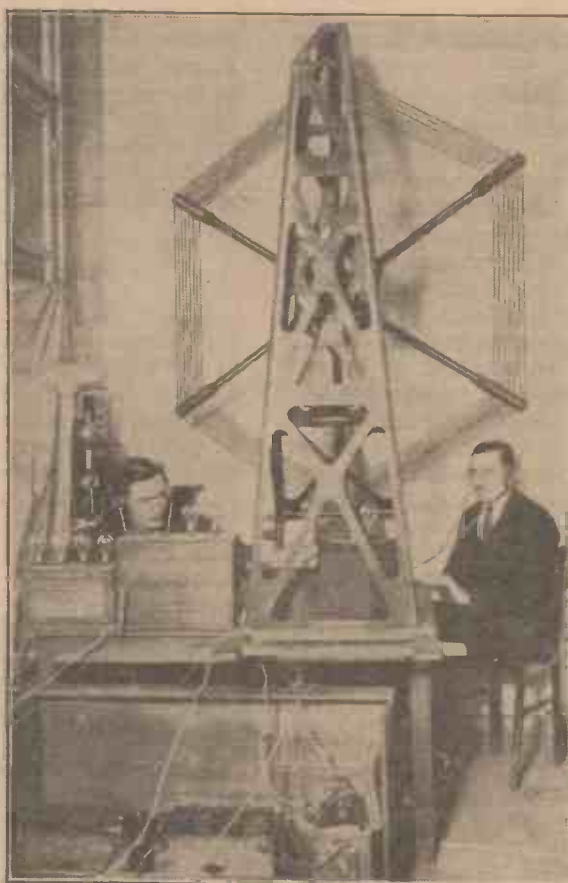

Le Bourget radio station keeping in touch with passenger-carrying aeroplanes.

masses of India react to the new medium? It is good to know that the new scheme does go beyond the European population, which hitherto has had a practical monopoly of what little broadcasting there is in India. If imagination and adaptability are displayed in this great enterprise there is a good



# WORKING WITH TWO VALVES and a CRYSTAL

By *E. J. Marriott.*

*A set for receiving the local station at loud-speaker strength while, in addition, more distant stations can be heard on the telephones.*

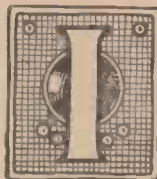

It is probably quite true to say that the first wireless receiver made by many wireless enthusiasts consisted merely of a single tuned circuit across which was placed a crystal detector and telephones. One outstanding feature will always be associated with that simple arrangement, however—*i.e.*, the purity of the signals received.

### The Next Step

Following the crystal set, possibly one valve was added to obtain louder signals, and after having worked this arrangement for a period, the probability is that the desire for loud-speaker results was only satisfied by the addition of yet another valve acting as a second L.F. amplifier.

With a crystal detector and two L.F. valve amplifiers following, good loud-speaking can be obtained up to approximately 15 miles or so from a main broadcasting station.

### Limited Range

In most cases, however, besides Daventry, the local station is the only one within range of such a receiver. Several enthusiasts, having two valves at their disposal, discard the crystal, and arrange the first valve as a detector, the second functioning as a single-note magnifier. The crystal, however,

is a useful detector, and now that there are so many of the semi-permanent types to be obtained and the trouble of continually setting the crystal contact is obviated, it can with advantage be retained in a valve receiver, thus allowing the valve which would otherwise act as a detector to be utilised as either H.F. or L.F. amplifier.

### Arrangement Adopted

In designing the receiver to be

receiver is shown in Fig. 1. The circuit  $L_1 C_1$  is connected across the grid and filament of  $V_1$  in a conventional manner, a potentiometer being incorporated in order that a positive bias can be applied to the grid, if necessary, to overcome self-oscillation of the valve. The aerial can be either directly coupled or auto-coupled to the grid circuit by altering the position of the lead from the aerial terminal. The anode circuit connections of  $V_1$  are, perhaps, not so familiar to many readers. The anode, as will be seen, is connected to H.T. + via a tapped R.F. choke, this choke preventing the amplified high-frequency impulses from passing through the H.T. battery. A path for the H.F. impulses is provided via the condenser  $C_3$  through the tuned circuit  $L_2 C_2$  and thence back to the filament.

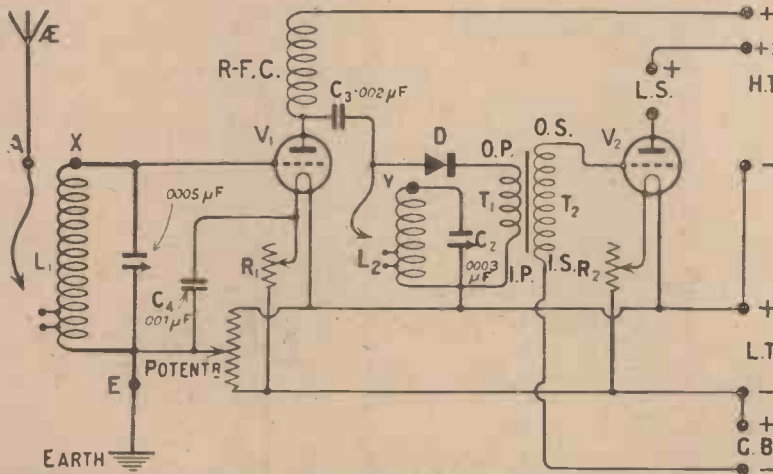

Fig. 1.—In the anode circuit of  $V_1$  is a tapped R.F. choke.

described, it was desired that the local station should be received on the loud-speaker over a distance of approximately ten miles, whilst good telephone signals should also be obtained on other more distant stations. For this reason one valve is arranged as an H.F. amplifier, the crystal detecting, and the second valve as an L.F. amplifier.

### The Theoretical Circuit

The theoretical circuit of the

of course, merely prevents the H.T. battery from being short-circuited. In this manner oscillation troubles, which may arise due to varying resistances developed in a well-used H.T. battery, are minimised.

It will be observed that a crystal detector is joined to the condenser  $C_3$ , the lead common to both being joined to a tapping point on  $L_2$ .

The primary  $T_1$  of the L.F. transformer is in series with the crystal, and the secondary of this transformer is connected across  $V_2$  in the orthodox manner.

ranged at the back of the base-board on a terminal strip.

**Components Used**

The actual components used in

Cabinet, 14 ins. by 7 ins. (with baseboard). (The Artcraft Co.)

Panel, 14 ins. by 7 ins. by  $\frac{1}{4}$  in. (Trelleborg genuine ebonite.) (F.W. Lowenadler.)

Two panel brackets.

One terminal strip with 7 terminals. (Peto Scott Co., Ltd.)

One tapped R.F. choke. (Peto Scott Co., Ltd.)

Two spring clips. (Peto Scott Co., Ltd.)

One square-law cam-vernier variable condenser, .0005  $\mu$ F capacity (Polar). (Radio Communication Co., Ltd.)

One square-law cam-vernier variable condenser, .0003  $\mu$ F capacity (Polar). (Radio Communication Co., Ltd.)

Two 30-ohm "Yesly" filament rheostats. (Engineering Supplies, Ltd.)

(If employing bright emitters, then 7-ohm rheostats will do.)

One 800-ohm potentiometer. (The British L.M. Ericsson Mfg. Co., Ltd.)

Two board mounting single coil mounts (Quality). (Goswell Engineering Co.)

One P.M. crystal detector. (Radio Instruments, Ltd.)

Two "Lotus" buoyancy valve-holders. (Garnett, Whiteley & Co., Ltd.)

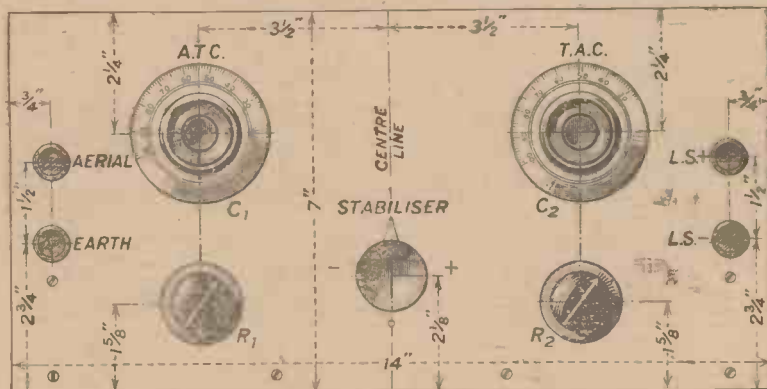
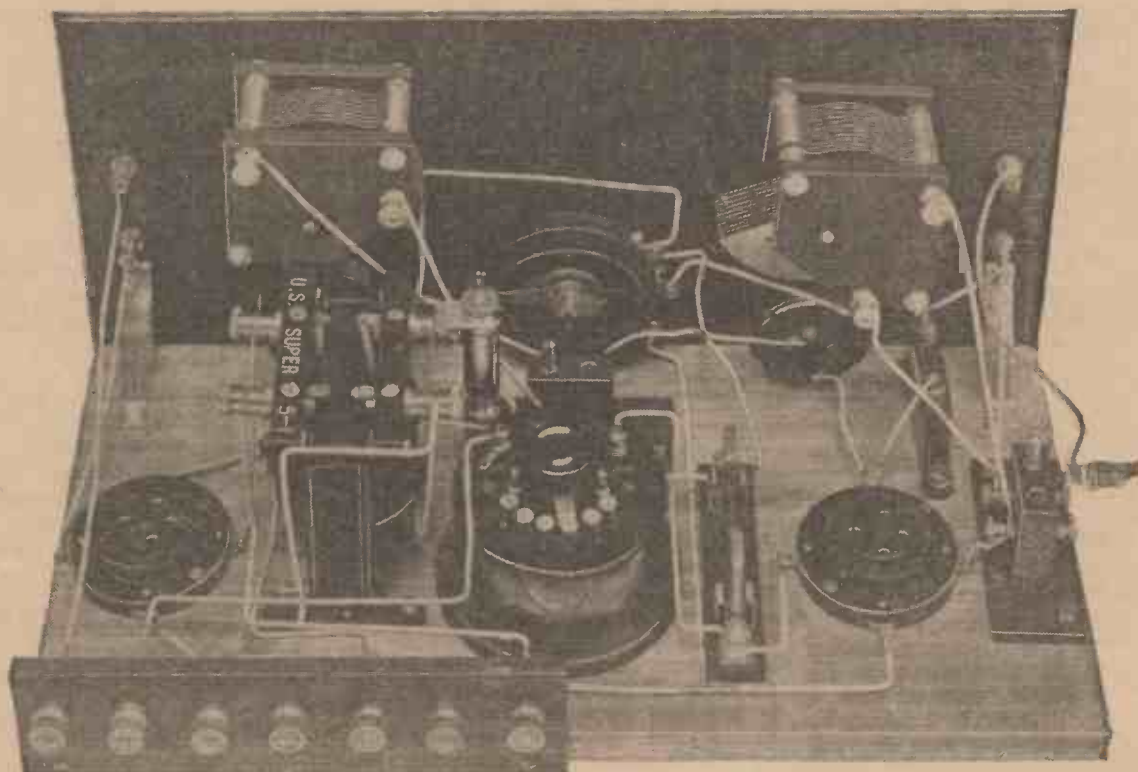

Fig. 2.—Only four terminals appear on the front panel. Blue Print No. 148a. Price 1/6 post free.

**The Completed Instrument**

The completed receiver itself, as can be seen in the photographs accompanying this article, is both neat and compact, the panel layout being symmetrical. The only terminals appearing on the panel are those necessary for the aerial and earth and telephones or loud-speaker connections, all the battery terminals being ar-

this receiver, together with the makers' names, are given in the following list, but you can make use of other good quality components, such as are advertised in the columns of this journal. Make certain first, however, that you have sufficient space available. In the set described, full use has been made of the whole of the base-board, there being no room to spare.



The disposition of the components can be clearly seen in this photograph. Note the relative positions of the two coil plugs.

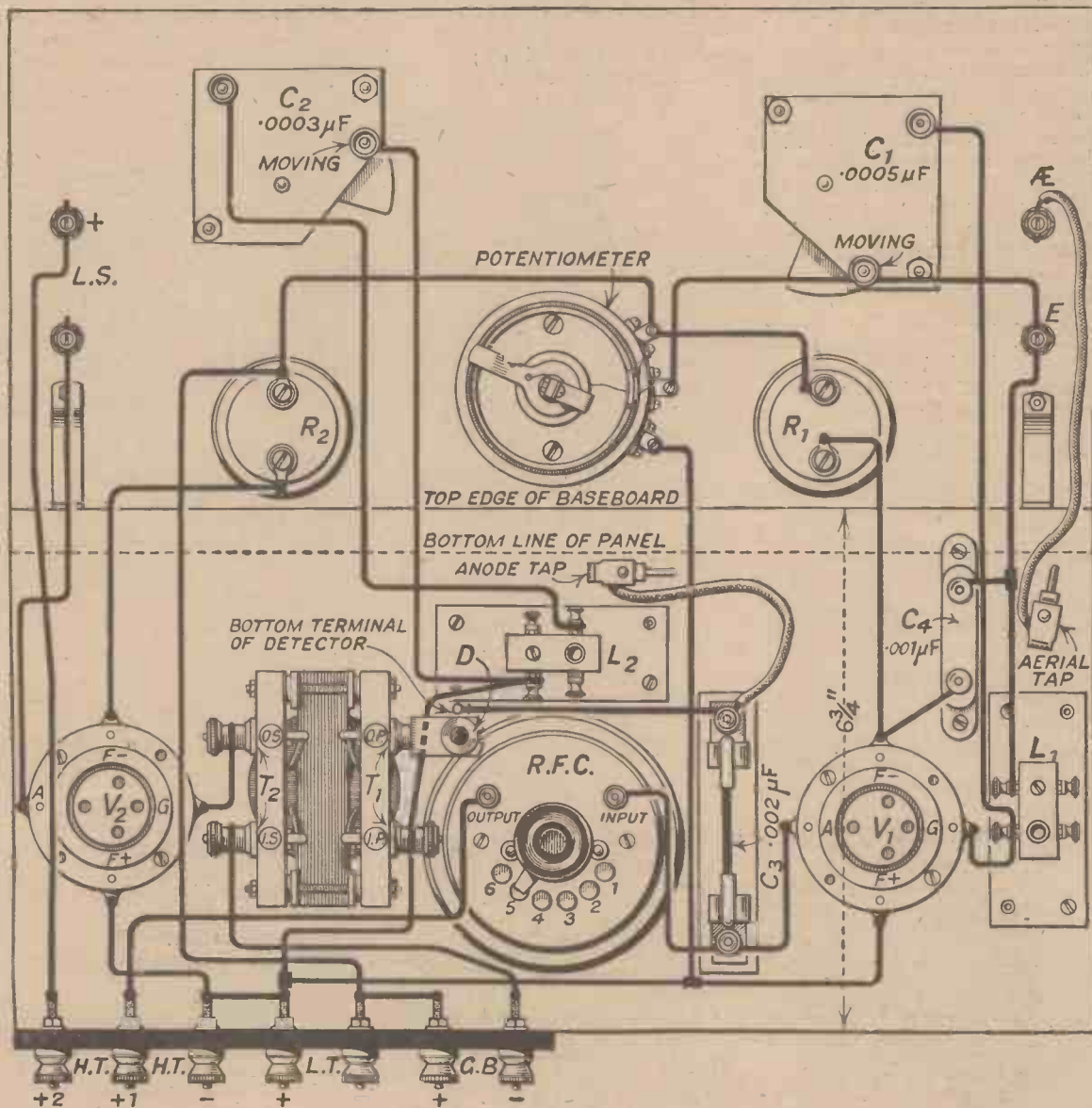

Fig. 3.—The wiring of the receiver may be easily followed from this diagram, blue prints of which may be obtained if desired. Blue Print No. 148b. Price 1/6 post free,

One clip-in fixed condenser with base, .002  $\mu$ F capacity. (L. McMichael, Ltd.)

One fixed condenser, .001  $\mu$ F. capacity. (Telegraph Condenser Co.)

One L.F. transformer, 5:1 ratio (Super). (U. S. Radio Co., Ltd.)

Four engraved terminals—Aerial, Earth, LS+, LS—. (Belling-Lee Co., Ltd.)

Quantity of Glazite, short length of flex, screws, nuts, etc.

**Construction**

First of all mark out the panel in accordance with the drilling diagram given in Fig. 2, and drill the various holes. Having com-

pleted this, with the baseboard in the cabinet, place the panel in position against it, and secure it to the baseboard by means of four wood screws. Now affix the terminal strip to the baseboard in a similar manner, thus ensuring a good fit into the cabinet.

The various components carried on the panel may be mounted in their correct positions, and it will be found advisable, at this stage, before screwing the other components on to the baseboard, to solder the leads to the two rheostats, as later on this would be a rather difficult operation, because

of space. The various components can now be assembled on the baseboard, adhering as nearly as possible to the arrangement shown in the photographs and diagrams.

**A Warning**

Be careful to place the two coil-holders as shown, as otherwise undesirable stray coupling effects may be introduced, and the control of oscillation may become very difficult.

Make sure also that there is ample room for coils and valves to be inserted without fear of them fouling any of the other components.

For convenience, the crystal detector, which is one of the semi-permanent types, has been fixed directly to one terminal of the L.F. transformer primary winding, so that it is behind the panel and out of the way of meddling hands.

Once this detector is set, it should not require readjustment, and it will be found to retain its sensitivity for a long period. Further, to vary the detector contact whilst the set is in operation, will probably result in self-oscillation of  $V_1$  occurring, with consequent interference to one's neighbours.

**Wiring**

The rest of the wiring can now be carried out and, when complete, should be carefully checked up against the wiring diagram given in Fig. 3. Having satisfied yourself that all is in order, the set may be tested out.

**Testing Out**

Insert a general purpose type of valve into each of the valve-holders and a No. 60 X coil in the holder for  $L_1$ , clipping the flexible aerial lead on to one of theappings.

For  $L_2$  use a No. 60 "X" or centre tapped coil, which in this receiver was of Lissen make, and connect the flexible anode lead to one of theappings. Now connect up the various batteries, applying

correct, with about 4 volts negative grid bias. Connect the aerial and earth leads and the telephones to the correct terminals; turn the potentiometer to the positive

crystal should be left alone. No improvement will result from continually altering its adjustment.

If the potentiometer is now adjusted slowly from positive to

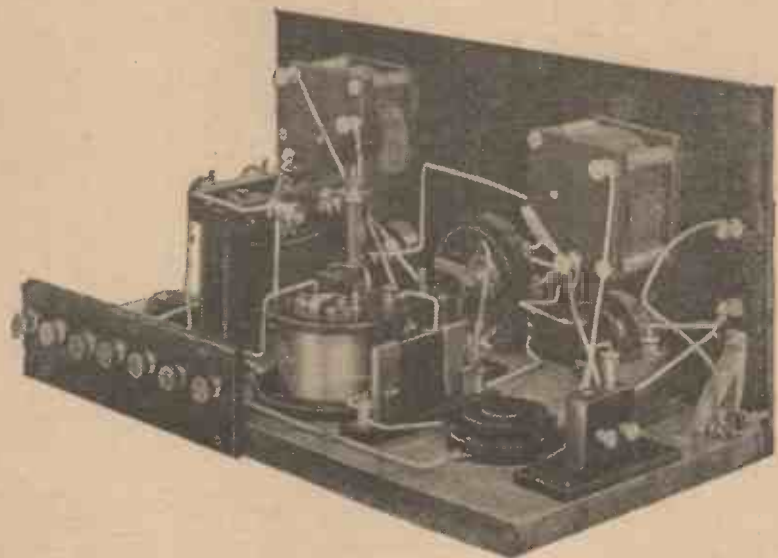

The crystal detector, mounted on a terminal of the L.F. transformer, is set once and for all when first testing the receiver.

position, and switch the tapped H.F. choke on to the third stud from the input side.

The valve filaments must now be lighted to their correct bril-

negative, it will be found that signals increase in strength until at a certain point the set will go into oscillation. This last feature, of course, must be avoided, the potentiometer being set to the adjustment which gives the loudest pure signals. In some cases, with certain valves, it may be found that oscillation does not take place, whatever the adjustment of the potentiometer. It will be found, however, that there is one position for best signals, and this should be carefully noted.

Should your local station be within ten miles, you will find that its signals will be sufficiently strong to enable a loud-speaker to be worked satisfactorily.

Signal strength is, of course, not so strong at a short distance from a station as that obtained from a crystal followed by two transformer coupled note magnifiers. Against this, however, must be set the fact that fairly distant stations can be received in the headphones, whilst with the crystal and two L.F. arrangement, besides 5 XX, the local station is generally the only one within range.

**Reception of 5XX**

For the reception of 5XX,  $L_1$  might be a No. 250 X coil, whilst for  $L_2$  a No. 200 or 250 "X" coil will be found suitable. On these

(Continued on page 815.)

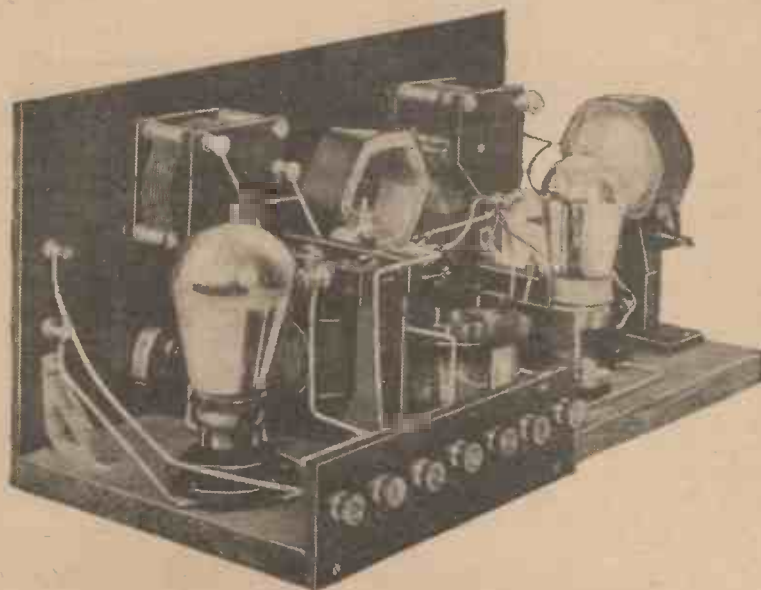

All the battery terminals are mounted behind the receiver.

the appropriate H.T. voltage to each valve. The exact H.T. necessary will, of course, vary with different types of valve, but generally about 60-70 volts on  $V_1$  and 80-90 on  $V_2$  will be found

liancy, and tuning on the two condensers should enable you to hear the local station at loud strength. After finding the local station, the best adjustment for the crystal can be obtained, after which the



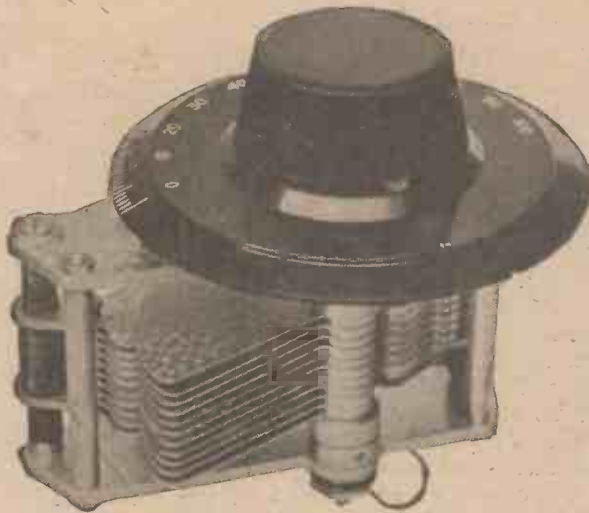

## The Era of Low Loss

by

**H. J. BARTON-CHAPPLE,**  
*Wh.Sch., B.Sc. (Hons.), A.C.G.I.,  
 D.I.C., A.M.I.E.E.*

*The design of components to fulfil the conditions of low loss is most important. This article indicates the salient points to be observed.*

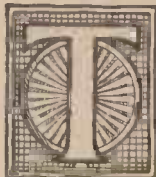

THE past year has seen enormous strides made in the construction of wireless receiving apparatus; and this progress is to be commended, for it is largely the outcome of the fact that more attention is being paid to those details which have previously been overlooked in the "fever heat" consequent upon the realisation of the vast potentialities of wireless. The applications of the principles of wireless have manifested themselves in many unlooked for directions, but for the present we shall confine our attention to an examination of those facts in so far as they concern the majority of the readers of this journal, that is in the efficient reception of wireless signals for broadcast programmes.

### Component Details

Many of the Radio Press staff have shown in the columns of the various Radio Press journals that distinct improvements in wireless receivers are possible by paying particular attention to component details, which components have often undergone radical changes in their construction, while many new ones are in various stages of development. The words "low loss" have become somewhat of a slogan with various manufacturing firms, as can be seen by an examination of the detailed advertisements, which go to great lengths in an endeavour to bring before the potential customer the advantages of their particular wares from the point of view of the reduction of undesirable losses.

### An Undesirable Feature

These points must not be deprecated in any way, for they are indicative of the many improvements made in all directions by the amateur constructor and the professional wireless engineer. What is an undesirable feature is the frequent complete misapprehension of facts, which has led to a diversion of useful energy into such channels that only an imperceptible increase in efficiency has resulted. This may be attributed

to a failure to appreciate that the problems of low loss are not nearly so obvious as at first sight they would appear to be. Again, in certain parts of a particular piece of receiving apparatus, the losses are so low relative to the other parts that improvements effected in the former portion, often brought about by a complete alteration in the construction, produce no appreciable difference in the final results.

It should therefore be at once clear that the correct relationship between the various components and the attendant apparatus which go towards making a complete wireless installation must be viewed in the correct light. It becomes necessary to know whether attention should be turned to the condenser, inductance coils, trans-

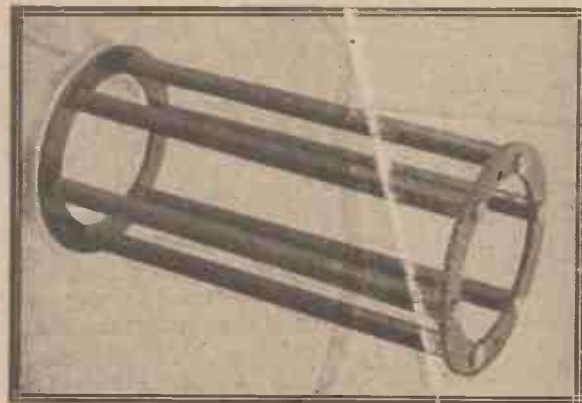

Frequently a former of the type shown here is used for winding low loss coils.

formers (air- and iron-core), the aerial and earth system, valve-holders, etc., and in what direction improvements may be effected, before credence can be given to the somewhat rash statements which are prevalent at the moment.

### Inductance Coils

Mr J. H. Reyner has devoted a great deal of time and attention to the questions influencing

the resistance of coils. It has been pointed out that there has been an increased tendency to incorporate special types of coil mounting and coil winding in which the resistance has been



Stranded wire can be used with advantage for winding low loss coils.

reduced as far as possible. The main object in view is to obtain an improvement in selectivity without the necessity for recourse to reaction effects, which may introduce certain undesirable features. This promotes stability in a receiver, and selectivity with stability should be the aim of all constructors. The formers employed in coil construction should as far as possible have a minimum of dielectric, and all necessary supports must be designed without the presence of unnecessary metal.

#### The Presence of Metal

If metal is present eddy currents will be set up and a certain amount of energy will manifest itself as heat, and consequently this will constitute a direct loss as far as signal strength is concerned. Dry air is practically a perfect dielectric, and consequently it would appear that air-spaced formers and windings are desirable features. The problem does not end here, however, for questions of cost and compactness enter into the field. To construct a large inductance with air-spaced windings of a single layer type, under ordinary conditions, results in a long coil, and this may be inconvenient. A reduction in the length of the wire may be brought about by using thin wire, which enables fewer turns to be employed for the same inductance, and thus, since the length of the wire is reduced, the increase in resistance consequent upon the wire having a smaller diameter is somewhat counterbalanced by a reduction in the total length of the wire.

#### Self-Capacity

Attention must also be focussed on the question of self-capacity, which quantity is present to a larger or smaller degree depending upon the type of winding, the insulation between turns (and layers when more than one layer is used), the material for the former, and the methods of bringing out the ends of the coil for making connections to the other parts of the associated apparatus in the receiver. These questions,

together with a consideration of high-frequency resistance as a whole, were quite recently discussed by the author in the columns of this journal, and consequently will not be duplicated in this article.

#### Stranded Wire

Reverting once more to the question of wire suitable for coil winding, it should be apparent that if a large number of individual strands are used in parallel to form the resultant conductor, then the final resistance will be reduced. Special precautions must be taken in the construction of this multi-stranded wire, however, if all its benefits are to be secured. The strands should be adequately twisted throughout their length so that each strand takes up a position on the outside of the conductor as well as at the core. In addition, the individual strands should really be insulated from one another if maximum efficiency is to be secured. No solid soldered joints should be made, as the distribution of the current in each strand would be considerably affected at these joints, and losses would occur. A refinement is introduced if every strand is taken separately and soldered to the outer cylindrical surface of a special terminal, but this process is, of course, very lengthy if the number of strands is very large.

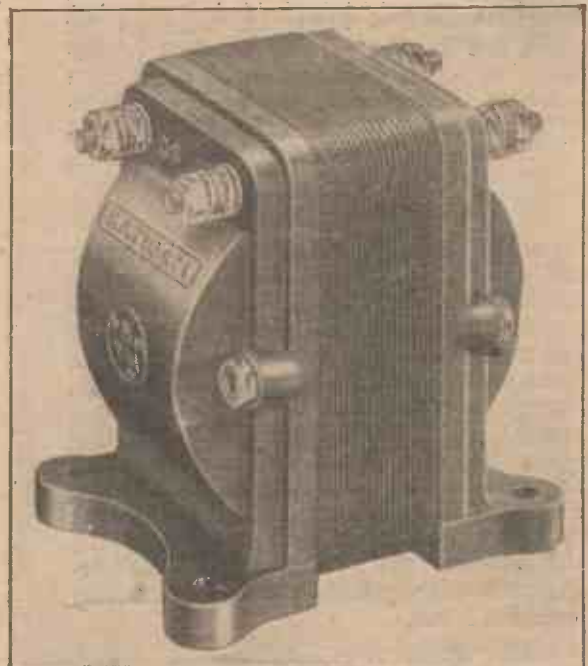

Best quality thin stampings of high-grade magnetic material should be used for L.F. Transformers.

#### Actual Resistance

With all these precautions the resistance of coils for the broadcast band of frequencies varies between about 7 and 20 ohms, whereas if these

points are not given the necessary attention, the resistance may be anything up to 70 ohms, or even more. Further comment is thus superfluous.

### Low Loss Condensers

Leaving the problem of coils and coming to condensers, it will be appreciated that remarkable progress has been made in the construction of these components. Losses do exist in condensers, and in an article in *Wireless Weekly*, Vol. 7, No. 20, the author dealt at length with the important points to be considered. The total losses are really due to a variety of causes, included in which may be mentioned the dielectric leakage both across and through the material employed, hysteresis losses, eddy current losses (shown as heat) in the metal portions and contact resistance. Materials of the best quality should of course be employed throughout, while the effects of moisture must not be overlooked.

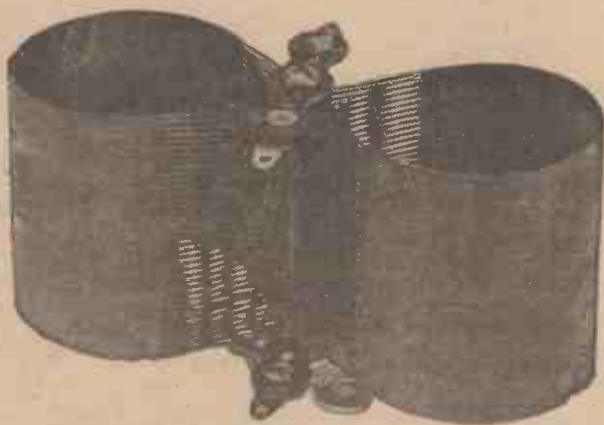

The Bodine "Twin Eight" R.F. Transformer is designed to have a small external magnetic field.

### Contact Resistance and Dust

The contact resistance in variable condensers between the spindle of the moving plate and the connecting terminal is often the source of a relatively large loss, and this connection should preferably be made through the medium of a thin helical spring. The presence of dust between the plates is liable to introduce errors, as the alternating voltage across the plates will cause very rapid movements of these particles which will be registered as a resistance. When manufacturing the condenser plates the metal employed should not be liable to rapid oxidisation, since the resultant film formed over the surface alters the capacity calibration and introduces a loss.

### An Equivalent Resistance

The effect of the loss of power in a condenser can be regarded as equivalent to a resistance in series with it, but when all the possible sources of losses are taken into full consideration, it will be found that this resistance, with a modern high-grade variable condenser, is less than half an ohm. It is thus seen that when the condenser

is considered in conjunction with the coils with which it is employed the loss in the condenser is out of proportion to those of the coils. Provided the condenser is constructed in a sound mechanical manner, with reliable material and the insulating material reduced to a minimum, the final component should have a natural low loss.

### Transformers

Many of the features mentioned about coil construction, etc., have a direct application to transformers. In the case of iron-core transformers particular attention must be paid to the metal forming the core. A complete magnetic path is essential, that is, no bad joints must be made between the central limbs and the cross pieces. Best quality thin stampings of high-grade magnetic material are very desirable to reduce all iron losses, both eddy current and hysteresis. From these considerations it will be apparent that short circuits between the stampings due to burred edges must not occur, while the insulation between the individual stampings may take the form of a sprayed liquid, or even the oxidisation on the plate sides themselves will suffice. The number of turns on the primary and secondary windings is limited largely by considerations of the resultant self-capacity; thus very large step-up ratios or very high primary or secondary impedances are not possible.

### Air-Core Transformers

In connection with air-core transformers for high-frequency working we find that many of the remarks made concerning inductance coils are applicable to this component. Just recently a great deal of attention has been directed to the question of stray magnetic fields and the resultant interaction effects. Failure to appreciate these salient points has led to the inefficient construction and working of many wireless receivers, so that the layout of the components of a particular receiver must be studied in great detail. Many high-frequency transformers are now appearing on the market which are constructed in such a manner that the resultant external magnetic field is considerably reduced, and consequently the losses will of necessity be automatically reduced. The problems arising from coil field influences are mainly responsible for the cautions generally given to prospective constructors of receivers designed by the Radio Press staff, that if the layout of a set is departed from, the efficiency will probably suffer in consequence.

### Valve-holders

Although the function of this component may be regarded as quite of minor importance, it is surprising how an inefficient valve holder will upset the working of a receiver. The quality of the insulating material employed should be of the highest grade, while the connections from the valve sockets to the soldering tags or terminals must not be of a flimsy character. The reduction of

(Continued on page 756.)

# Regular Programmes from American Broadcasting Stations

*Hours of transmission given in Greenwich mean time and in local time prevailing.*

*Telephony only. • Corrected up to February 15th, 1926.*

*Edited by Captain L. F. PLUGGE, B.Sc., F.R.Ae.S., F.R.Met.S.*

Ref. No.	G.M.T.	Local Time prevailing.	Station.	Call Sign and Wave-length.	Town.	Nature of Transmission.	Approx. Duration
<b>WEEK-DAYS.</b>							
A. 1	Midnight	7.0 p.m. E.S.T.	Gimbell Bros.	WIP 508.2 m.	Philadelphia, Pa.	Children's Corner	1 hr.
A. 2	Midnight	6.0 p.m. C.S.T.	"Kansas City Star"	WDAF 365.6 m.	Kansas City, Mo.	Talks, Stories, Music	1 hr.
A. 3	Midnight	6.0 p.m. C.S.T.	Westinghouse Elec. & Mfg. Co.	KYW 536 m.	Chicago, Ill.	Dinner Music	1 hr.
A. 4	Midnight	6.0 p.m. C.S.T.	Chicago Tribune Broadcasting Co.	WGN 370 m.	Chicago, Ill.	Dinner Concert	—
A. 5	Midnight	7.0 p.m. E.S.T.	Goodyear Tyre & Rubber Co.	WEAR 389.4 m.	Cleveland, Ohio	Orchestra (except Saturday)	1 hr.
A. 6	Midnight	6.0 p.m. C.S.T.	Woodmen of the World	WOAW 526 m.	Omaha, Nebraska	Talk or Concert (except Wed.)	1 hr.
A. 7	Midnight	7.0 p.m. E.S.T.	Henry Field Seed Co.	KFNF 266 m.	Shenandoah, Iowa	Concert	2 hrs.
A. 8	Midnight	6.0 p.m. C.S.T.	Fort Worth Star Telegram	WBAP 475.9 m.	Forth Worth, Texas	Dinner Music (except Sat.)	½ hr.
A. 9	Midnight	7.0 p.m. E.S.T.	Jewett Radio & Phonograph Co.	WJR 517 m.	Detroit, Mich.	Orchestra and Soloist	2 hrs.
A. 10	Midnight	7.0 p.m. E.S.T.	Chesapeake Tel. Co.	WCAP 469 m.	Washington	Market News followed by Concert (Mon., Wed. and Fri.)	4 hrs.
A. 11	Midnight	6.0 p.m. C.S.T.	Sears-Roebuck & Co.	WLS 345 m.	Chicago, Ill.	Variety Concert (except Sat.)	2 hrs.
A. 12	12.30 a.m.	7.30 p.m. E.S.T.	John Wanamaker	WOO 508.2 m.	Philadelphia, Pa.	Dinner Concert (Mon., Tues. and Fri.)	1 hr.
A. 13	1.0 a.m.	7.0 p.m. C.S.T.	St. Louis Post Dispatch	KSD 545.1 m.	St. Louis	Concert (except Tues. and Thurs.)	2 hrs.
A. 14	1.0 a.m.	8.0 p.m. E.S.T.	The Shepherd Stores	WNAC 280.3 m.	Boston, Mass.	Concert	1½ hrs.
A. 15	1.0 a.m.	8.0 p.m. E.S.T.	Watch Tower	WBRR 272.6 m.	Staten I., N.Y.	Concert and News (Mon., Thur. and Sat.)	1 hr.
A. 16	1.0 a.m.	8.0 p.m. E.S.T.	"The Detroit News"	WWJ 352.7 m.	Detroit, Mich.	News and Music (Mon., Wed., Fri.)	1 hr.
A. 17	1.0 a.m.	8.0 p.m. E.S.T.	Westinghouse Elec. & Mfg. Co.	WBZ 333.1 m.	Springfield, Mass.	Concert or Musical Programme (except Sat.)	30 min.
A. 18	1.0 a.m.	8.0 p.m. E.S.T.	Westinghouse Elec. & Mfg. Co.	KDKA 309 and 64 m.	Pittsburg, Pa.	News, Talk, Market Reports (except Sat.)	15 min.
A. 19	1.15 a.m.	8.15 p.m. E.S.T.	Westinghouse Elec. & Mfg. Co.	KDKA 309 m. and 64 m.	Pittsburg, Pa.	Address from University (except Thurs. and Sat.)	¾ hr.
A. 20	1.15 a.m.	8.15 p.m. E.S.T.	Radio Lighthouse	WEMC 286 m.	Berrion Springs, Mich.	Concert	1½ hr.
A. 21	1.30 a.m.	7.30 p.m. C.S.T.	Fort Worth Star Telegram	WBAP 475.9 m.	Fort Worth, Texas	Musical Programme (except Sat.)	1 hr.
A. 22	2.0 a.m.	9.0 p.m. E.S.T.	American Radio Co.	KFQX 394 m.	Washington, D.C.	Concert (Thurs., Silent)	—
A. 23	2.0 a.m.	3.0 p.m. C.S.T.	"Kansas City Star"	WDAF 365.6 m.	Kansas City, Mo.	Musical Programme	2 hrs.

Ref. No.	G.M.T.	Local Time prevailing.	Station.	Call Sign and Wave-length.	Town.	Nature of Transmission.	Approx. duration.
----------	--------	------------------------	----------	----------------------------	-------	-------------------------	-------------------

WEEK DAYS (Contd.).

A. 24	2.0 a.m.	8.0 p.m. C.S.T.	Chicago Tribune Broadcasting Co.	WGN 370 m.	Chicago, Ill.	Vocal and Instrumental Music (except Mon.)	1 hr.
A. 25	2.0 a.m.	9.0 p.m. E.S.T.	Westinghouse Elec. & Mfg. Co.	KDKA 309 m. and 64 m.	Pittsburg, Pa.	Concert or Variety Entertainment (8.30 Wed., Sat.)	50 min.
A. 26	2.0 a.m.	9.0 p.m. E.S.T.	Rensselaer Polytechnic	WHAZ 379.5 m.	Troy, N.Y.	Concert, Address, Dance Music (Mon. only)	2 hrs.
A. 27	2.0 a.m.	6.0 p.m. P.S.T.	"Morning Oregon"	KGW 491.5 m.	Portland, Oregon	Dinner Concert	1 hr.
A. 28	2.0 a.m.	8.0 p.m. C.S.T.	Wilbur Glenn Voliva	WCBD 344.6 m.	Zion, Ill.	Concert (Tues. and Thurs.)	2 hrs.
A. 29	2.0 a.m.	9.0 p.m. E.S.T.	Pittsburg Press, Kaufman & Baer Co.	WCAE 461.3 m.	Pittsburg, Pa.	Concert, Music (Mon., Tues., Wed and Thurs.)	1 hr.
A. 30	2.55 a.m.	9.55 p.m. E.S.T.	John Wanamaker	WOO 508.2 m.	Philadelphia, Pa.	U.S. Naval Observatory Time Signal, followed by U.S. weather forecast	—
A. 31	2.55 a.m.	9.55 p.m. E.S.T.	Westinghouse Elec. & Mfg. Co.	KDKA 309 and 64 m.	Pittsburg, Pa.	Do. do.	—

SUNDAYS.

A. 32	11.30 p.m.	6.30 p.m. E.S.T.	Westinghouse Electric & Mfg. Co.	KDKA 309 and 64 m.	Pittsburg, Pa.	Dinner Concert	1 hr.
A. 33	Midnight	7.0 p.m. E.S.T.	Westinghouse Electric & Mfg. Co.	WBZ 333.1 m.	Springfield, Mass.	Concert or Music, etc.	—
A. 34	Midnight	7.0 p.m. E.S.T.	Chesapeake Tel. Co.	WCAP 469 m.	Washington, D.C.	Musical Programme and Organ Recital	2 hrs.
A. 35	Midnight	6.0 p.m. C.S.T.	Woodmen of the World	WOAW 526 m.	Omaha, Nebraska	Bible Study Hour	1 hr.
A. 36	Midnight	7.0 p.m. E.S.T.	Carleton College	KFMY 337 m.	Northfield, Minnesota	College Vesper Service	1 hr.
A. 37	12.15 a.m. (Monday)	7.15 p.m. E.S.T.	Shepherd Stores	WNAC 280.3 m.	Boston, Mass	Church Service	1 hr.
A. 38	12.20 a.m. (Monday)	7.20 p.m. E.S.T.	American Tel. & Tel. Co.	WEAF 492 m.	New York	Musical Programme	2 hrs.
A. 39	12.30 a.m. (Monday)	7.30 p.m. E.S.T.	General Elec. Co.	WGY 379.5 m.	Schenectady, N.Y.	Church Service	1 hr.
A. 40	12.30 a.m. (Monday)	7.30 p.m. E.S.T.	Strawbridge & Clothier	WFI 394.5 m.	Philadelphia, Pa.	Church Service	—
A. 41	12.30 a.m. (Monday)	7.30 p.m. E.S.T.	Henry Field Seed Co.	KFNF 266 m.	Shenandoah, Iowa	Divine Service	1 hr.
A. 42	12.45 a.m. (Monday)	7.45 p.m. E.S.T.	Westinghouse Electric & Mfg. Co.	KDKA 309 and 64 m.	Pittsburg, Pa.	Divine Service	1 hr.
A. 43	1.0 a.m. (Monday)	7.0 p.m. C.S.T.	Westinghouse Electric & Mfg. Co.	KYW 536 m.	Chicago, Ill.	Service and Musical Programme	2 hrs.
A. 44	1.0 a.m. (Monday)	7.0 p.m. C.S.T.	Sear-Roebuck & Co.	WLS 345 m.	Chicago, Ill.	Church Service	1 hr.
A. 45	2.0 a.m. (Monday)	8.0 p.m. C.S.T.	Wilbur Glenn Voliva	WCBD 344.6 m.	Zion, Ill.	Concert	2 hrs.
A. 46	3.10 a.m. (Monday)	9.10 p.m. C.S.T.	Woodmen of the World	WOAW 526 m.	Omaha, Nebraska	Chapel Service	1 hr.
A. 47	3.20 a.m. (Monday)	7.20 p.m. P.S.T.	"Morning Oregonian"	KGW 491.5 m.	Portland, Oregon	Church Service	1½ hrs.
A. 48	4.0 a.m. (Monday)	8.0 p.m. P.S.T.	General Electric Co. Pacific Coast Broadcasting Station	KGO 361 m.	Oakland, California	Divine Service	—
A. 49	4.0 a.m. (Monday)	11.0 p.m. E.S.T.	Watch Tower	WBBR 272.6 m.	Staten I., N.Y.	Bible Lecture and Sacred Music	1½ hrs.
A. 50	5.0 a.m. (Monday)	11.0 p.m. C.S.T.	Fort Worth Star Telegram	WBAP 475.9 m.	Fort Worth, Texas	Concert	1 hr.



# Readers' Results

*A few interesting experiences with Radio Press Sets.*

### The "Special Five"

SIR,—Perhaps the following may be of interest to those constructing the Special Five, or may encourage others to try this circuit.

Having had experience of many of your leading sets, including the STroo, Transatlantic Five, T.A.T. and several straight circuits, I can confidently say I have found it unrivalled for quality, volume, selectivity and DX work.

The difficulties met with in constructing may perhaps be useful information to some. Despite the advice of its designer I did depart slightly from the exact design laid out. Each valve is provided with a separate rheostat, thus enabling the first valve to be turned out when receiving the local station. On Manchester (8 miles away) the set functions perfectly with this valve extinguished, passing the signals through to the second valve. For the output connections I have put three jacks on the front of panel, one after detector, one after first L.F. and one after the last valve. The last stage of L.F. I have made choke coupled instead of resistance capacity. Choke coupling I find gives equal purity, greater volume and requires less H.T. voltage. For the choke I used an old Igranic transformer with primary and secondary coupled in series.

With the set arranged as stated I find the first and last valve are unnecessary for the local station which works a large loud-speaker with perfect purity on the three centre valves. I found that using the first three valves (2 H.F. and detector) there was not enough power for my speaker (which requires considerable input). In all other respects the set conforms to standard design. I have used Colvern condensers, which are excellent, enabling calibration to be executed with greater ease than with the ordinary type, making fine tuning a joy.

This circuit was first tried out with Cossor Wuncell valves, which I had by me, but DE<sub>5</sub> valves are now used for the H.F. and last stage L.F., DE<sub>5</sub>B before the choke and a bright emitter "R" type as detector. With these valves the results are amazingly good, surpassing all others that I have had. Using the coil loose coupled is essential to cut out the nearby station for wavelengths within about 15 metres; but, of course, it makes the set more liable to oscillate. I have tried a tapped X coil, but it does not make a big increase in selectivity compared with the loose coupling. Incidentally, I find results vary considerably with different types of aerial coils and I am looking forward to many interesting experiments trying different types of inductances.

In conclusion, may I thank Mr. Percy Harris for the excellence of this Special Five set.—Yours truly, *Altrincham.* J. W. BYROM.

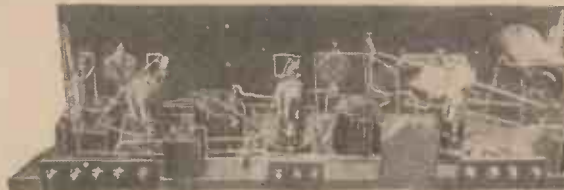

Mr. Green's two valve power amplifier with a detector unit added.

### A Two Valve Power Amplifier

SIR,—I am enclosing a photograph of a set I have constructed. You will no doubt recognise the two stages of low-frequency as they were described by Mr. C. P. Allinson, in the November, 1925 issue of MODERN WIRELESS (every copy of which I have had from No. 1), under the heading of a Two-Valve Power Amplifier. As it was set out so well, I designed a detector unit to complete a three-valve set with the result that after spending over £150 in constructing dozens of sets I have now obtained one that is capable of picking up any European station, to say nothing of the main B.B.C. stations. Up to

the present I have logged 40 stations on the loud-speaker, and this is mainly due to the excellent design of the amplifying unit. As a very keen reader of your publications, I can assure you that your hints, information, designs, etc., have given me many happy hours of study and pleasure.

Wishing your journal the success it deserves.

Yours truly,

L. T. GREEN.

*Leigh-on-Sea.*

### The Three Valve "Prince" Receiver

SIR,—I have never been absolutely satisfied with the production of tone from the different sets I have built until now. I have built 1-2-3-4- and 5-valve sets, but I wanted something that would produce sound from the receiver as perfect as it was sent into the microphone at the other end. The Three-Valve "Prince" Receiver, described by Mr A. S. Clark in the Jan., 1926, issue of MODERN WIRELESS, has proved the best I have heard so far. When listening to Irene Scharer in her Pianoforte Recital, the music, in purity, was never produced any better than that which came through my loud-speaker.

I note this is only a local station receiver, but still I do not think I should have heard that piano any better even if I had been in the London studio listening to it. This receiver has that for which I have been trying for the last three years to get—*purity of reproduction.* It is the best set I have had, and far the best set I have heard for loud-speaker purity of reproduction—and I have heard many, not only in wireless agents but at exhibitions as well, but my keen ear for purity has been sorely tried.—Yours truly,

FREDK. C. HARVEY.

*Glasgow.*

# A SET FOR VALVE RECTIFICATION EXPERIMENTS

By A.V.D. HORT, B.A.



Many experimenters are no doubt anxious to compare grid current and anode current rectification. The set described here will enable many interesting comparative tests to be made.



THE method of rectification in valve circuits which enjoys the greatest popularity nowadays employs a grid condenser and leak to maintain the grid of the valve at a suitable potential. Quite possibly a number of people do not realise the existence of other methods of obtaining rectification, and probably still more have never given such methods a practical trial. Rectification with a grid condenser and leak, or cumulative grid rectification, as it is termed, is so simple to obtain with components "of the usual value" that it is commonly adopted in receivers without question.

### Rectification with Strong Signals

For general all-round reception cumulative grid rectification possesses the advantage of simplicity, both in operation and in the constructional work involved. When strong telephony is received, however, cumulative grid rectification tends to produce a certain amount of distortion as compared with, for instance, anode current rectification. On the point of actual signal strength the cumulative grid method will normally have the advantage over the anode current method, unless valves specially designed for the latter method are used. From the standpoint of the quality of reproduction, however, with correct operation of the valve anode current rectification is often superior.

### A Double Purpose Receiver

It is well known that it is practically impossible to construct two wireless receivers which are exactly identical in performance, so that

the comparison of these two methods of rectification with two receivers, one using cumulative grid and the other anode current rectification, would prove unsatisfactory. The receiver to be described here, the theoretical diagram of which is shown in Fig. 1, was constructed, therefore, to include both methods in the one circuit, the change over from one method to the other being effected simply and rapidly.

different instruments. So much depends on the individual estimate of quality that the comparison in this case must be left to the individual. For the actual comparison however, it is of great assistance if the sounds to be compared by the ear can be set as nearly as possible "side by side." For instance, it is much easier to compare the reproduction of two loud-speakers if a switch is arranged to enable a rapid

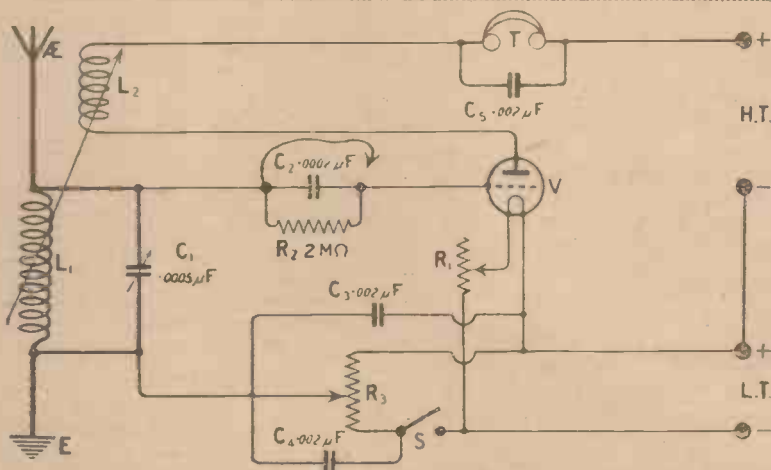

Fig. 1. The theoretical diagram shows the modification introduced when compared with the usual circuit for a single valve with reaction.

### Making Comparisons

With this instrument it is thus possible to listen to different parts of the same programme using either cumulative grid or anode current rectification. Quantitative measurements of relative signal strength may be made if desired. Unfortunately we have at present no standard means of comparing the quality of signals received with

change-over to be made from one to the other.

In the receiver illustrated on these pages, once the correct settings for the two methods of rectification have been found by trial, it is a matter of a moment only to change from the one to the other. Small defects in the quality of the signals produced by either method will thus be readily observed.

**Anode Current Rectification**

Anode current rectification, the alternative method used in this receiver, works best with fairly strong signals, failing the use of special valves. In actual operation the lower bend of the characteristic curve of the valve is utilised. Refer-

current are usually necessary in order to obtain the best results.

**Components Employed**

The list of the components required for the construction of the set is given here, together with the names of the makers of the com-

- Three .002 $\mu$ F fixed condensers. (Watmel Wireless Co.)
- One filament rheostat, 30 ohm. (Climax.)
- One potentiometer. (L. McMichael, Ltd.)
- One push-pull on-off switch. (Lissen, Ltd.)
- One Clix plug and socket. (Autoveyors, Ltd.)
- Ebonite panel, 7 ins. by 9 ins. by  $\frac{3}{8}$  in. (American Hard Rubber Co., Ltd.)
- Containing box to suit above panel and 4 ins. deep. (The Art-Craft Co.)
- One 2-coil holder. (W. J. Henderson and Co., Ltd.)
- Seven terminals and four valve sockets.
- Quantity of Glazite for wiring, and a few inches of flex.
- Packet of Radio Press panel transfers.

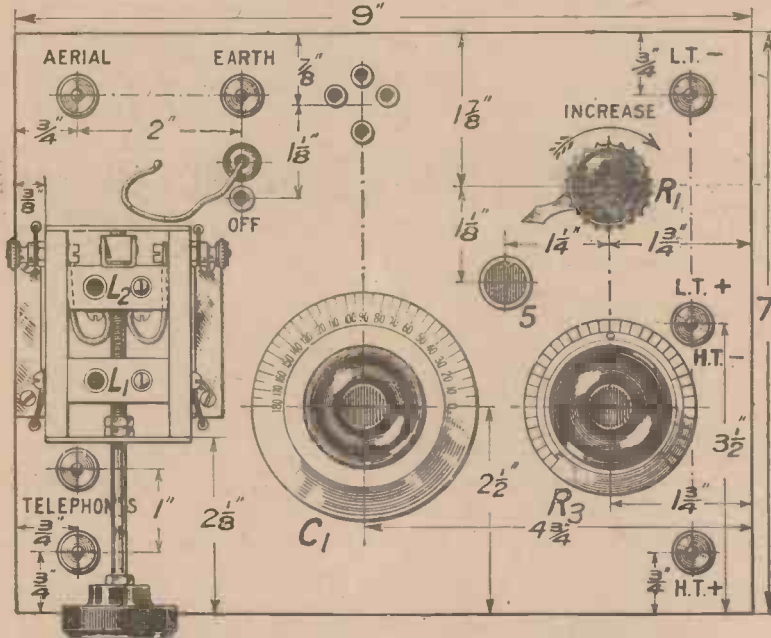

Fig. 2. The panel can be marked out by reference to this drawing,

**Marking out the Panel**

The first operation to be carried out in the construction of the set is the marking out of the panel. If components identical with, or similar to, those described are used, the required dimensions may be taken from the drilling diagram given in Fig. 2. The two holes for the bolts which secure the edge of the coil holder nearest to the panel edge should be drilled for tapping either 4 or 6 B.A. Care should be taken in marking the position of the filament rheostat, potentiometer and switch, as this last is placed close to the other two components mentioned.

**Mounting the Components**

In mounting the components, the three quoted above should be carefully placed in the positions shown in the back of panel wiring diagram (Fig. 4), in order that the wires between the various contacts may be short. Only two of the soldering tags on the switch are used, one making connection to the shaft and the other to the long contact. It will be noticed that connections are taken to all three terminals on the filament rheostat. This is merely for convenience in wiring, since the two outer terminals make contact with the metal frame of the switch and with the contact arm, while the centre terminal is connected to the resistance winding.

**Wiring**

The fixed condensers are soldered in position last of all, when the rest of the wiring is complete. Before the grid condenser is fixed in position, a small hole is drilled through the panel below the position which the condenser will occupy. A short length of flex, soldered at one end to the shank of the aerial

ence to Fig. 3, which is a typical characteristic curve of a three-electrode valve, will explain the method of operation. If we apply a negative bias of 4 volts to the grid of the valve, the steady anode current will be 0.4 milliamp. This point on the curve is represented by B in Fig. 3. Now suppose that the negative half cycle of an incoming signal applies 1 volt negative to the grid. The representative point will move to A on the curve, the resultant anode current being 0.2 milliamp. The positive half cycle of 1 volt, on the other hand, will cause the anode current to increase to 0.8 milliamp.

**Resultant Effect**

It will be seen, therefore, that the effect of an incoming signal will be to produce an average increase on the anode current. Also that rectification will be effected owing to the asymmetrical variations in the anode current, negative half cycles on the grid causing a decrease of 0.2 milliamp. and positive half cycles an increase of 0.4 milliamp.

In practice the correct working potential is applied to the grid of the valve by means of a potentiometer, while careful adjustment of the anode voltage and filament

ponents actually used. Deviations from this list are left to the discretion of the individual, but it should be noted that careful attention to the lay-out of the panel may be

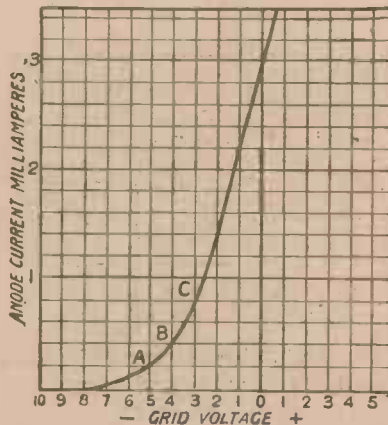

Fig. 3. The bottom portion of a typical valve characteristic curve.

necessary if parts other than those given are used.

One .0005  $\mu$ F variable condenser. (square-law low-loss). (Jackson Bros.)

One .0002  $\mu$ F combined condenser and 2M $\Omega$  leak. (Watmel Wireless Co.)



terminal passes through this hole and has a Clix plug fixed to its outer end. The side of the grid condenser remote from the aerial is soldered direct to a Clix socket; this arrangement provides for short-circuiting the grid condenser and leak when anode current rectification is to be used. A small hole in the panel close to the Clix socket accommodates the plug when the grid condenser is in use, thus obviating any risk of short circuits through the plug swinging loose and possibly making contact with one of the reaction coil terminals on the coil holder.

**Extra Grid Bias**

Since with some valves and with the higher values of anode voltage it will not be possible to apply sufficient negative bias to the grid with the potentiometer alone, when using anode current rectification, a tapped grid battery may be included in circuit when required, with the aid of a short additional lead. When this battery is in use the Clix shorting plug will be placed in its positive socket, while a length of flex with a Clix plug at each end should be connected between the appropriate negative socket and the Clix socket on the panel.

**An Unusual Position**

The telephone terminals are placed in a rather unusual position, nearly underneath the control rod of the coil holder. It will be found in practice that this is a convenient arrangement, as the telephone cords lie out of the way of the operator,

since they do not pass across the set and get in the way of the controls. A direct system of wiring is also made possible, from the anode of the valve through the reaction coil and the telephone to the positive high-tension terminal.

the switch specified has been fitted. If the valve lights up correctly on turning on the filament rheostat, the high-tension battery and the telephones may be connected up, a small value of high-tension, say 3 volts, being plugged in first of all,

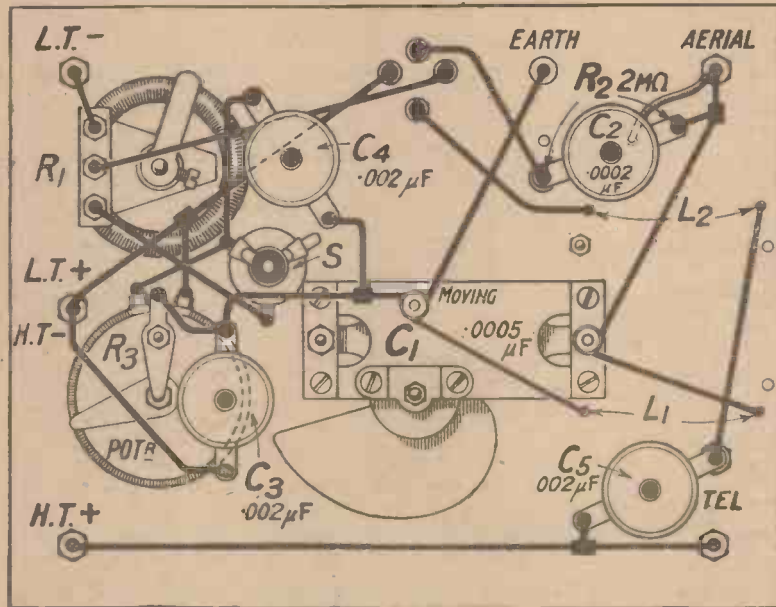

Fig. 4.—The wiring arrangement of the potentiometer, filament rheostat and switch should be carefully followed.

**Testing**

When the set is ready for use, a general purpose valve may be inserted in the socket, and the low-tension battery connected to the appropriate terminals. The potentiometer switch should be in the "off" position, that is, "up," if

in case of possible wrong connections. If the filament brilliancy does not change on plugging in this value of high-tension, a higher value may be plugged in, say 45 to 50 volts to begin with.

**The Initial Trial**

The grid condenser and leak should be in circuit at first, the Clix plug being placed in the "safety" hole in the panel. Attach the aerial and earth to the appropriate terminals, insert a No. 35 or 50 coil in the fixed coil plug and a No. 35 or 50 in the moving coil plug, keeping the coils well separated at first, and endeavour to tune in the transmission from the local station. If the set has been correctly wired, and if you are within a few miles of the local station, no difficulty should be experienced in obtaining good signals. Full signal strength may be obtained by slowly bringing up the reaction coil and readjusting slightly on the tuning condenser.

**A Caution**

With a set of this kind, which is intended for comparative testing purposes, it is a mistake to try and work too close to the oscillation point. One trouble which is likely to be experienced, if this is done, is that on changing over from one method of rectification to the other, the set may go into oscillation,

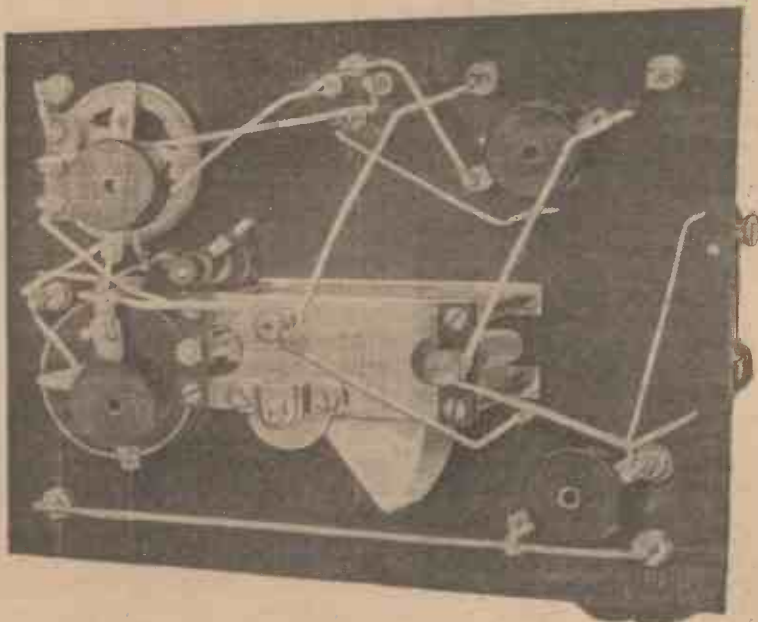

Four fixed condensers are soldered in position when the remainder of the wiring is complete.

causing unnecessary annoyance to other listeners.

When the local station has been tuned in satisfactorily, using the grid condenser and leak method of rectification, the alternative method may be tried. Insert the Clix plug in its socket, thus cutting out the grid condenser and leak, and push down the switch to bring the potentiometer into circuit. The potentiometer should then be adjusted until the best signal strength is obtained. Slight readjustment of the tuning condenser will probably be necessary. The setting of the filament rheostat also needs careful attention, and with some types of valves this will be found extremely critical for the best results.

distortion, when using either method of rectification, by pushing reaction too far. It was thus possible to obtain some estimate of the relative quality of the signals received, although of course no definite standards or figures can be given for this.

#### The Various Valves

The D.E.R. valve gave distinctly better signal strength with cumulative grid rectification, at all values of anode voltage, with the exception of the lowest value applied. At 21 volts high-tension cumulative grid rectification gave very poor signal strength, whereas with anode current rectification little difference in strength was perceptible when 21

#### Further Tests

When the change to anode current rectification was made, the adjustment of the filament rheostat became very critical at each value of anode voltage. Signal strength increased with the higher values of anode voltage, whereas with cumulative grid rectification little difference in signal strength could be detected with 42 and 55 volts on the anode. The setting of the potentiometer varied from fully negative at 55 volts anode voltage down to the 8th division on the negative scale at 21 volts (the scale on the potentiometer used is graduated in even divisions from the central zero point, the maximum negative or positive being 18 divisions of this scale).

With the D.E.R. valve it was necessary to bring the grid battery into circuit with all but the lowest value of anode voltage.

#### A Soft Valve

The soft Dutch valve gave the best results of the valves tested on anode current rectification. Only a slight difference in signal strength was noticeable on changing over from one method to the other. These results were to be expected, owing to the sharper bend and steeper curve of the characteristic of a soft valve. The signal strength with cumulative grid rectification was practically equal to that obtained with the two previous valves and with anode current rectification it was slightly less than this strength, though markedly better than that given by the other valves when using this method. With anode current rectification, both the filament rheostat and potentiometer settings were fairly critical, the latter being at 5, 10 and 18 divisions negative with anode voltages of 21, 30 and 42. Quite good results were also obtained with 14 volts on the anode. The higher anode voltage of 55 volts was not applied to this valve, as it shows the blue glow of ionisation when about 50 volts are used.

#### Quality

The experiments described were carried out on a short aerial, about 1½ miles from the aerial of the London station, so that ample energy was available to provide a fair test for the anode current method of rectification. In the opinion of the writer, the quality of the received signals was superior when anode current rectification was used. The best opportunity for comparisons of quality was afforded by the Dutch valve, as the maximum signal strengths obtained

(Continued on page 813).

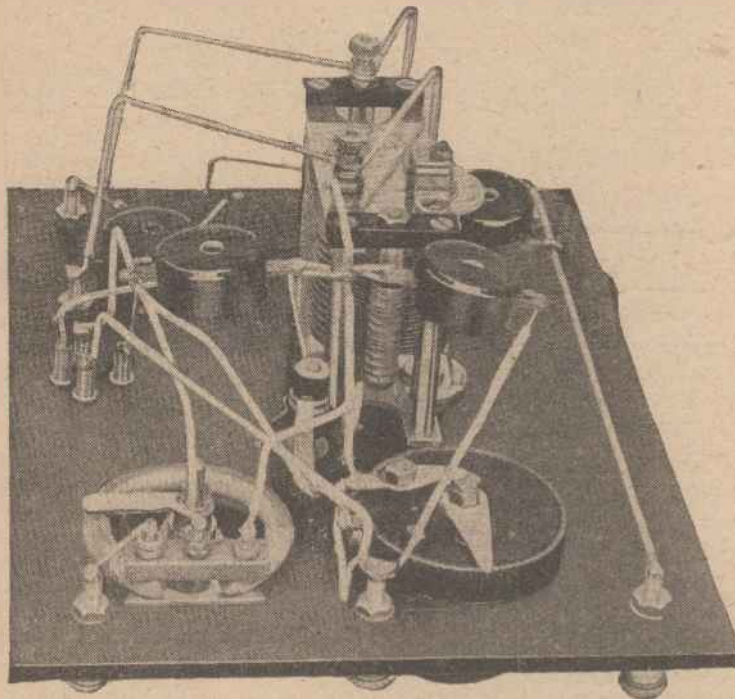

The three terminals of the filament rheostat are all used for connections, the outer pair being in contact with the metal frame and spindle.

If it is found that the potentiometer needs to be turned right round to the negative end, the grid battery should be put in circuit, sufficient cells being included to provide a definite setting on the potentiometer.

#### Comparative Tests

Tests were carried out on the set with three different types of valves, a Marconi D.E.R., a Cossor "red-top" H.F. (bright emitter), and a soft "Dutch" valve of the 4-volt bright emitter type. Each valve was tested both on grid condenser and leak and on anode rectification with various values of high-tension voltage, 21, 30, 42 and 55 volts. Care was taken not to introduce

or 30 volts were applied. The application of higher anode voltages increased signal strength slightly with cumulative grid rectification, while it tended to fall off with anode current rectification. The setting of the filament rheostat was not found to be critical with either method.

The Cossor valve also gave the best signal strength with cumulative grid rectification, at each anode voltage except 21 volts; with this voltage results were poor. The adjustment of the filament rheostat was not critical for the best signal strength, although no advantage was found in applying the full 4 volts with anything below 50 volts on the anode.

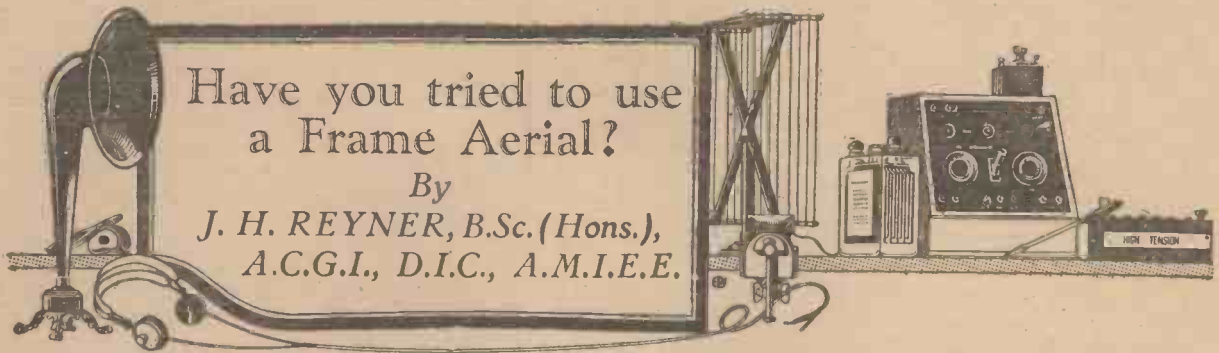

The benefits of frame aerial reception are not always realised, but this article points out the advantages to be gained by its use.

**T**HE use of a frame in place of the usual type of aerial has many advantages. In the first place the arrangement is compact and the receiver with its frame can, if necessary, be made self-contained. A further advantage with the frame aerial is that it is directional in its properties.

**Directional Properties**

This means to say that a frame will receive best when it is pointing in a certain direction relative to the particular transmitting station, and similarly there are other positions of the frame at which the reception is a minimum. By a proper design an actual zero of reception can be obtained, so that this method can be used to eliminate undesired signals.

The disadvantage of the frame aerial is that the actual received signals are considerably smaller than can be obtained on an ordinary outdoor aerial if the same receiver is employed, and for this reason many experimenters are loth to use a frame. There is no reason why this should be the case, however, and with suitable circuits some very interesting results may be obtained.

**Operation**

Before proceeding to discuss any actual circuits, it will be desirable to consider briefly how a frame aerial operates. The simplest type of frame aerial is a single turn of wire, or a loop. Fig. 1 shows such a loop of wire with a pictorial representation of the wireless wave moving past the loop. Now in an ordinary aerial the wireless waves moving past the aerial with a very high velocity set up small voltages in the aerial, and it is these voltages which produce the currents ultimately operating the telephone receivers. In the case of a frame aerial we have two vertical sides, joined by a horizontal top, with a horizontal bottom from the middle

of which we take the leads to the receiver.

**The Induced Voltage**

The wireless waves in striking the vertical sides of the frame will induce voltages in those two vertical

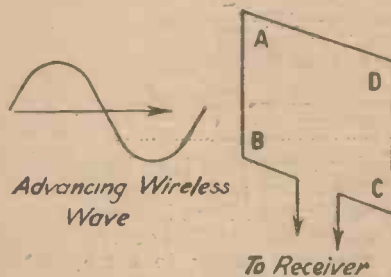

Fig. 1.—A simple frame aerial consists of a single loop of wire.

sides, but will have no effect upon the top or bottom portions because these portions are horizontal, and therefore at right angles to the direction of the electro-magnetic waves. It will be obvious that the direction of the voltages induced in the two sides of the frame will both be the same relative to the ground.

As far as the complete circuit of the frame is concerned these two voltages will be acting in direct opposition. That is to say, the current produced by the voltage in A B would tend to flow through the circuit in the direction A B C D. The current produced by the other voltage, however, which is in the direction D C would tend to flow round the circuit D C B A, which is in exactly the opposite direction to that produced by the first voltage. These two effects appear to cancel out, and we are left with nothing.

**The Time Lag**

How is it, therefore, that we can receive signals on a frame? The answer lies in the fact that there is a

very slight time elapsing during the transit of the wireless waves from one side of the frame to the other, i.e., the voltage produced in the rear side of the frame in Fig. 1, would be slightly later in all its variations than that produced in the front end. The result of this is that the two voltages do not completely cancel out, but leave a small residual voltage which is sufficient to produce signals in the receiver.

**Rotating the Frame**

If, however, we rotate the frame through an angle of 90 degrees, we have the frame at right angles to the direction of the wireless waves. In this case it will be clear that the wireless waves will strike both sides of the frame simultaneously, and there will not be any time lag, so that the currents actually will cancel out and no signals will be heard.

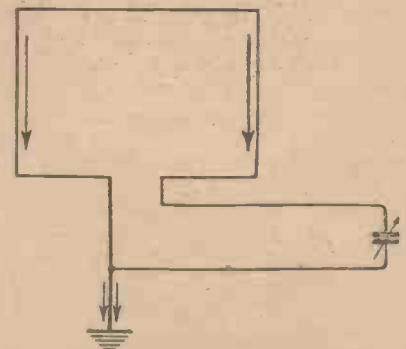

Fig. 2.—The currents on each side of the frame combine together in the earth lead.

It is this property which makes the frame respond to the direction of the wireless waves. It will be obvious that if we have the frame connected to a receiver and it is placed in the position shown in Fig. 1, then we shall receive maximum signals. As we rotate the

frame, however, the time lag between the voltages in each side will get less and less, so that the signals will be reduced in strength until finally when the frame is at right angles to the direction of the wave there will be no voltage at all. Further rotation of the frame will cause the signals to increase again until a maximum is obtained with the frame in a similar position to Fig. 1, with the exception that it has been turned round through 180 degrees.

**Other Features**

This may appear to be a somewhat peculiar way of regarding the action of a frame aerial, but it has

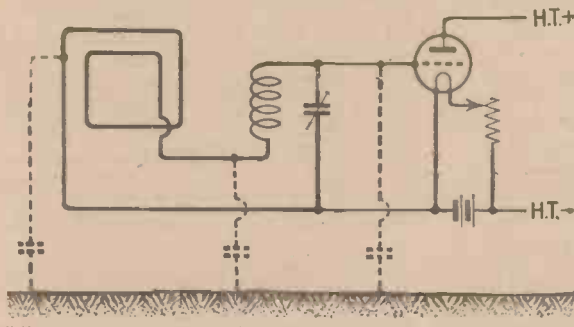

Fig. 3.—The various portions of the frame circuit have a capacity to earth.

several advantages. The first of these is that an ordinary frame also acts as an aerial. Fig. 2 will illustrate this point. It will be clear that although the two voltages A B and D C in the two sides of the frame nearly cancel out as far as the frame aerial itself is concerned, if we connected some point of the frame to earth instead of the receiver we should have a very small aerial, and the two voltages in the two sides would both act together and add up to produce a current in the earth lead.

Now this is an effect of considerable importance. The currents produced in the frame are very small because, as we have seen, they are due to the difference between the two voltages in the opposite sides. Consequently, although the frame has only a small effect when acting as an aerial in this manner, the currents produced by this means may be many times greater than those produced by the true frame action.

**Reducing Interference**

It is for this reason that the directional properties of a frame are sometimes not particularly marked. Many readers will have no doubt tried frame aerals with the express intention of using them to cut out interference, but will have been disappointed to find that the rotation of the frame made

very little difference, or at any rate did not produce any sharp cutting out of the interfering station.

This trouble is nearly always found to be due to the aerial effect of the frame, which stops its true action, and one of the principles of success in using a frame lies in the adoption of suitable precautions to avoid troubles from this source.

**A Simple Receiving Circuit**

Let us consider a simple receiving circuit. The frame aerial would be connected to the grid and filament of the first valve of the receiver, with a suitable loading inductance if necessary, and a condenser for

tuning the whole of the inductance of the frame and the loading coil. It will be seen from Fig. 3 that all these various portions of the circuit possess a capacity to earth, and the batteries of the receiver also possess a capacity to earth if they are not directly earthed, as is often the case. This means to say that currents can flow through the capacity of the frame and its attendant circuit to earth, and these will cause variations of the grid potential irrespective of the true signal voltages produced in the frame itself. Such voltages may often be appreciable because of the minute strength of the true frame current, so that even if the frame is not directly connected to the earth, we can obtain the aerial effect through the capacity to earth.

**Eliminating Capacity Effects**

A method of eliminating this trouble is to connect the middle point of the frame circuit to earth as in Fig. 4, and also the negative of the low-tension battery. Neglecting for the moment the question of the loading coil, it will be clear that the grid and filament sides of the frame then have equal capacities to earth, so that there will be no voltage difference between them due to any capacity currents which may flow.

If a loading coil is in circuit then it will be obvious that the symmetry

of the arrangement is destroyed, and the effect of earthing some other point of the circuit should be tried. It may even be found convenient to connect across the grid and filament of the valve two very small neutrodyne condensers and to connect the mid-point of these two condensers to earth. By a slight readjustment of these neutrodyne condensers one can obtain a point at which the aerial effect is completely eliminated, and crisp and sharp zeros can be obtained as the frame is rotated.

**A High-Frequency Amplifier**

It is assumed that a valve amplifier is being employed, because in order to obtain satisfactory results on a frame aerial at least one high-frequency valve is desirable. The use of a loading coil is to be avoided where possible because for maximum results the frame should be made as large as possible, consistent with obtaining an inductance of the right size. If the frame is made too large, then it will not be possible to tune up to the higher frequencies.

**A Suitable Circuit**

A suitable circuit employing a frame aerial with a suitable centre tapping is shown in Fig. 5, and if precautions are taken with this circuit no difficulty should be experienced in obtaining real directional effects and sharp zeros. This

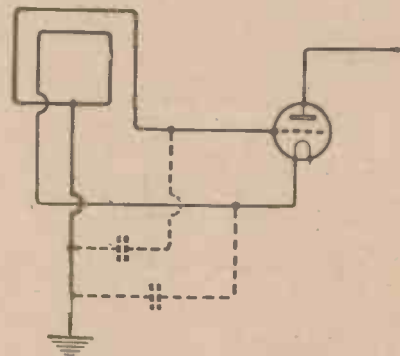

Fig. 4.—Connecting the middle point of the frame to earth eliminates capacity effect.

circuit has been neutrodyne in order to obtain the maximum efficiency from the high-frequency valve. The neutrodyne condenser may, for convenience, be employed to provide the necessary reaction. Such an operation is quite satisfactory where only one stage is employed, and quite reasonable control is possible.

**Barrage Reception**

It is interesting to note that in many cases the aerial effect of the frame is actually employed to increase the signals and to produce other forms of directional effects. For example, one often finds that the station that one desires to receive is on the opposite side to the station to be eliminated. Obviously a simple frame would be useless under such conditions. We should have to place the frame at right angles to the direction of the undesired station, in which case it would be at right angles to the direction of the desired station, and no signals would be obtained.

In such a case what is known as barrage reception may be employed.

**An Explanation**

To obtain this it is necessary to utilise both the aerial effect and the frame effect, and the combination of these two will produce the required uni-directional reception. The actual current flowing in the frame circuit depends upon the direction of the frame, *i.e.*, if we rotate the frame through 180 degrees, then, although the reception will still be a maximum, the actual direction of the current at any instant will be in the opposite direction to what it was previously. On the other hand the current in an ordinary aerial is independent of the direction of the wireless waves and this of course applies to the aerial effect of the frame.

It is conceivable, therefore, that if we couple the frame to the receiver, both as a frame and as an aerial, we shall obtain a condition of

**A Useful Circuit**

A circuit to achieve this result is shown in Fig. 6. Here we have the frame entirely isolated from the receiver, which is coupled to the frame by means of two pick up coils. One of these is responsive to the frame effects of the coil, *i.e.*, it is in series with the frame and a suitable tuning condenser, whereas the other one makes use of the aerial effects of the frame, due to the currents flowing from the frame to earth. In series with the earth lead

of, which tends to overcome any interference which might be experienced from this cause.

**Useful Experiments**

There are many very interesting effects which may be obtained with this type of circuit, and it is one that can be recommended to readers for experimental purposes. For good results at least one high-frequency valve, and possibly two should be employed. These may be of the ordinary type and may

Fig. 6.—A suitable circuit for obtaining barrage reception.

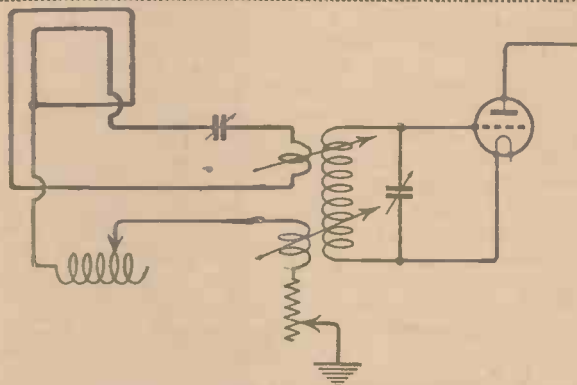

is a high resistance with a variable inductance for obtaining an approximate tune.

**The Necessary Adjustments**

In operating the receiver, one adjusts the value of the resistance until the current due to the aerial effect of the frame is equal to the current produced by the frame effect. By a suitable adjustment of the coupling coils it is then possible to obtain a balance when the frame is pointing in one direc-

tion, which tends to overcome any interference which might be experienced from this cause. Reaction may be provided, if required, in order to obtain satisfactory signal strength. As a means of eliminating interference and particularly for those who wish to attempt distant reception when situated very close to a high-power station the use of a frame opens up many possibilities and will repay experiments.

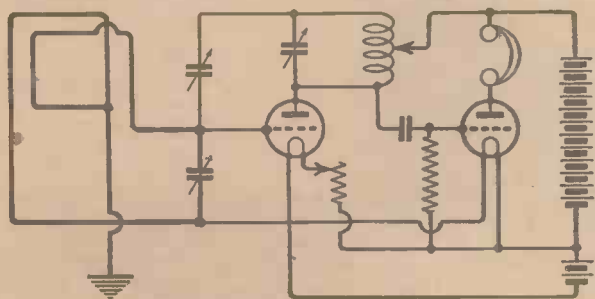
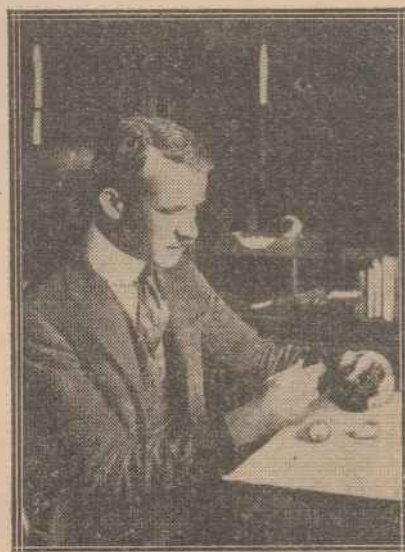

Fig 5.—A neutrodyne frame aerial circuit.

affairs where for one station the aerial and frame balance out, and for a station in the opposite direction they assist each other and produce a maximum. This will give us a zero in one direction only, and a maximum reception in the opposite direction, which, of course, is the position required for the particular case just mentioned.

tion, and it will be found that on rotating the frame through 180 degrees a maximum reception will be obtained in an opposite direction.

This is also useful, because the maximum strength of signals obtained with this arrangement is twice that which can be obtained with the frame acting by itself, and also the aerial effect is made use



The size of a quartz crystal used at the U.S. Bureau of Standards for controlling a transmitter is indicated in this photograph.

# The Transatlantic Tests



THE experience of listeners generally this winter has been that broadcasting stations on the far side of the Atlantic have not been easy to pick up, even with the most sensitive apparatus. The numerous reports which we have had on attempts to receive the American stations during the Tests' week indicate that failure to hear anything definite was the rule rather than the exception.

That the unfavourable conditions were not confined to a small area is evidenced by the fact that

KDKA and WGY at the higher frequencies, which normally are audible on almost any night of the year, were almost as difficult to locate as the lower frequency transmissions. One listener, in Dublin, was able to hear the higher frequency transmission from KDKA on the morning of January 27th, practically the whole programme being logged with the aid of a three-valve receiver, consisting of a detector and two low-frequency amplifying valves. This, however, is the only report received of satisfactory reception even at this frequency.

On the first two mornings of

listening on a six-valve super-heterodyne receiver with a frame aerial at the Elstree Laboratories was able to pick up faint signals from three stations. According to the measurements of wavelength noted, these stations were WJAZ, Chicago, WLW Cincinnati and WGY Schenectady. We await further confirmation of the items received, however, before stating definitely that these were the stations heard.

Many listeners took advantage of the exceptional opportunity afforded them of receiving the Continental stations between 4 and 5 a.m. each morning. The reports show that most of the stations came in well. It may be noted that the Prague station was



A group of prominent radio men at a dinner in New York prior to the departure of Messrs. Eric Palmer and Thornton Fisher (3rd and 4th from the right respectively) in connection with the arrangements for the recent Transatlantic Tests.

reports which have come in from widely separated localities all tell much the same story. Actual atmospheric disturbances and Morse interference are quoted by some listeners as factors contributing to the failure of their efforts. These do not, however, account for the apparent "deadness" of the ether which was observed.

Not only the ordinary broadcasting band of frequencies was affected. The transmissions from

the tests, January 25 and 26 the American hour was curtailed by S.O.S. calls from ships off the coast of America. The broadcasting stations were compelled to close for half an hour or more each morning, to enable the traffic incidental to the distress signals to be expeditiously handled.

On January 29 a very slight improvement in the conditions for reception was observed. A member of the Radio Press staff

working at a frequency slightly below that of Madrid (EAJ7), although scheduled to transmit at a higher frequency. Radio Iberica (EAJ6), Barcelona and San Sebastian were also sending out special test transmissions during the week.

We take this opportunity of expressing our thanks to all those who have sent in reports.

Since the above report was written, we have received confirmation from America of the reception of WJZ, Boundbrook, at 3.45 a.m. on January 26th, by a listener in Surrey.

# The Curvature of Valve Characteristics

By Major JAMES ROBINSON, D.Sc., Ph.D., F.Inst.P.

*A particular feature of valve characteristics has been singled out by Dr. Robinson for a critical examination.*



AN examination of valve characteristics gives us much information, and there are some features that demand, and obtain, very careful attention. As regards the anode current/grid volts characteristic there are the types of

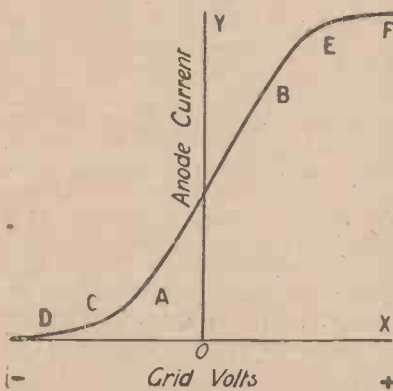

Fig. 1.—A representative valve characteristic.

curvature at the bottom of the characteristic, and also at the top, though many published valve characteristics do not show what happens at the top; the appearance of what is called the "straight part" of the characteristic, whether it is actually straight or how steep it is; the magnitude of the maximum anode current; and how the characteristics are disposed laterally with regard to the zero grid volts. Each of these features has its own peculiar importance and indicates how a particular valve can best be used.

### The Bottom Curvature

It is proposed to discuss some aspects of the bottom curvature of the characteristics, and to indicate some reasons why, with the present-day valves, this curvature is comparatively gradual instead of being abrupt. In passing we will merely mention that what is called the straight part of a characteristic,

the portion A B of Fig. 1, is not absolutely straight, but for most purposes can be regarded as such.

### A Typical Characteristic

A typical anode current/grid volts characteristic is shown in Fig. 1, and it can be divided into five portions. The first portion is D C, where the anode current is practically zero, no matter what the grid volts may be for that portion of the characteristic. The second portion is C A, which is curved. The third portion, A B, is usually called the straight part of the characteristic, where changes of anode current are proportional to changes of grid volts. The fourth portion, B E, is again curved, while the fifth portion is usually nearly straight and approximately parallel to the grid volts axis.

### Anode Current Rectification

The curved portion C A is some-

form of rectification is not particularly efficient is because of the usual gradual slope of the characteristic. In Fig. 2 this portion of the characteristic is shown as F B E, and a train of waves such as  $a b c d$  arriving at the grid is shown to vary the grid volts from D to C. The mean position is A, and for this value of grid volts the anode current is A B. When the grid volts are taken to C, the anode current rises to C E; and for the grid volts D, the anode current falls to D F. Because of the curvature of the characteristic the increase of anode current for the positive halves of the waves is greater than the decrease for the negative halves. Thus there is a wave of anode current  $a' b' c' d'$  about a line B H, the portions above this line being larger than the portion below the line. The result of this is to raise the mean value of the anode current whilst the train of waves lasts.

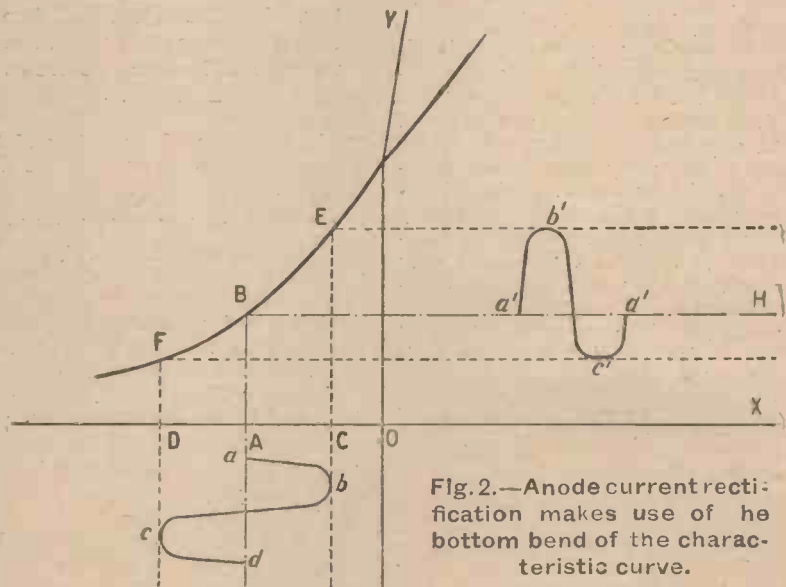

Fig. 2.—Anode current rectification makes use of the bottom bend of the characteristic curve.

### Increase of Curvature

Had the curvature of the characteristic been much greater this

times used for rectification purposes, *i.e.*, when employing anode current rectification. The reason why this

should have had a greater difference between the increase of the anode current and the corresponding decrease, thus producing a greater change of mean anode current during the train of waves. Hence for the best rectification the characteristic should have a sharp bend.

Attempts are constantly being made to design valves with very sharp bends. At the same time, of course, it is advisable to have

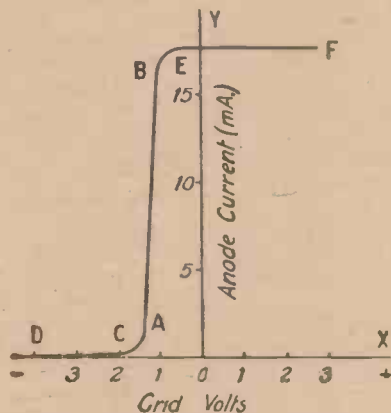

Fig. 3.— Sensitive rectification would be possible with a curve of this nature:

the curve very steep immediately after the bend, so that a small increase in grid volts will produce a large increase in anode current. If it was possible to obtain a characteristic such as that shown in Fig. 3, with a very sharp bend at the bottom, and a very steep portion immediately afterwards, we should have very sensitive rectification.

**Soft Valves**

Present-day valves are hard, which means that they are exhausted to such an extent that there is very little gas left in them. In any case there is not sufficient gas to allow any appreciable ionisation to be produced. When, however, some gas is retained at a very low pressure, and ionisation is obtained, the valve will possess very much sharper and steeper characteristics. The trouble with such valves, which are called "soft" valves, is that they are very variable in performance, and the amount of gas present varies with the different conditions of working, so that the amount of ionisation cannot be guaranteed.

**A Typical Case**

A typical instance was the Round valve, which was exceedingly sensitive, but during operation the gas was absorbed by the electrodes and by the walls of the glass, and it was necessary to fit a projecting tube

with some material which would give off gas when heated slightly. It is stated that much better and more constant results can be obtained by using helium in the bulb in place of air, at a pressure which remains constant during operation.

The next point for discussion is the reason why the characteristic of a hard valve has such gradual curvature.

**Velocity of Electrons**

One of the reasons is the fact that the electrons which constitute the anode current leave the surface of the filament with different velocities. Measurements of the velocities of electrons are reckoned in centimetres per second, but as these approach very large values, such as ten million to one thousand million centimetres per second, it is much more convenient to have some other method. Resort is made to "volts," which at first sight appears unsound because volts do not appear to have any connection with velocities. The relation is, however, quite easy to understand, since an electron, being a negatively charged particle, is susceptible to electric fields. When such a field of a definite number of volts per centimetre acts on an electron, it accelerates or retards it, according

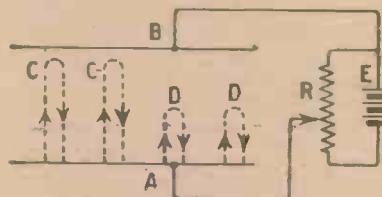

Fig. 4.—The path of the electrons depends upon the voltage difference between B and A.

to the direction of the field and to the initial direction of travel of the electron.

**The Theoretical Relationship**

If the volts applied =  $V$ , and if we give the usual nomenclature to the features of the electron,  $m$  for its mass,  $e$  for its electric charge, and  $v$  for its velocity, we have the relation

$$eV = \frac{1}{2} m v^2$$

As  $e$  and  $m$  are absolute constants we have the relation that the square of the velocity of the electron is proportional to the volts applied.

Electrons leave the surface of the filament of a thermionic valve with varying speeds up to the equivalent of about one volt.

Let us suppose for a moment that this variation of velocity

amongst the different electrons does not occur, and that all leave the filament with a speed equivalent to one volt. We will further suppose that the filament is heated in some way other than by passing an electric current through it, so that its whole length is at the same electric potential. Now consider that we have an anode B which completely or nearly surrounds the filament, as in Fig. 4, where A

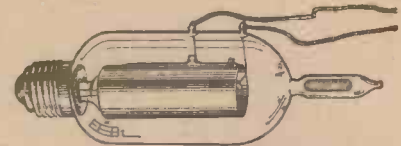

An early soft valve designed by Captain H. J. Round.

represents the filament, and that we can vary the potential between the anode and filament by means of a battery E with a potentiometer R.

**A Special Case**

All the electrons have the same velocity of one volt, so that when there is no potential difference between A and B, all the electrons will reach the anode B. Now alter the potential of B with regard to A to a fraction of a volt in the direction to retard the electrons, in other words make B slightly negative with respect to A. The electrons will still reach B, although they will all have their speed reduced before doing so. As soon as we make B one volt negative with regard to A, all the electrons will just fail to reach B. In this case they will travel almost to the anode B and then they will lose their forward velocity and be turned back, acquiring the velocity of one volt again on reaching the filament. They will thus follow paths as shown at C.

**The New Characteristic**

If we make B two or more volts negative, all the electrons will be

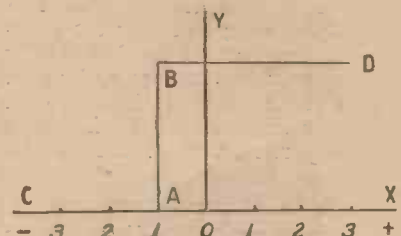

Fig. 5.—A characteristic never realised in practice.

turned back much sooner, as indicated by the paths D.

The characteristic we should obtain under these circumstances





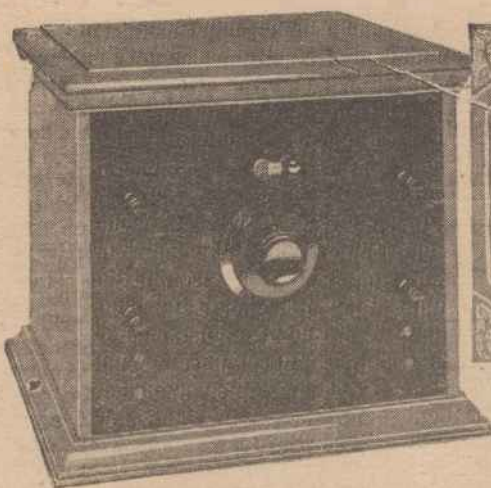

**ARE YOU  
GETTING THE BEST  
FROM  
5XX?**

*By*  
**STANLEY G. RATTEE, M.I.R.E.**

*In this receiver a special coil is used for the reception of Daventry, while the local station is tuned in with a plug-in coil.*

**M**OST of the crystal receivers one sees described nowadays cater for the reception of the local station by utilising a

special coil may be used for long-wave reception, with provision for a crystal tapping at a suitable point.

ment direct coupling is used for either short or long waves,  $L_1$  being a plug-in coil.

In the second circuit, which is also suitable for either the local station or 5XX,  $L_1$  is a Lissen X coil of a size suitable to cover the wavelength used by the station desired. The circuit for using the special long-wave coil and crystal tapping is shown in the third arrangement, the positions of the three clips being again indicated by the letters A, B and C.

**Simple Construction**

In order that the actual constructional work may be simplified, the popular American style of cabinet with an upright ebonite panel has been adopted, the base-board serving as a convenient support for the plug-in coil-holder and special long-wave coil. The remainder of the components, including the terminals, are mounted direct upon the panel.

**Components and Materials**

The construction of a receiver of this type does not call for any but the ordinary skill, and as a guide to those readers who are desirous of building such a set as this, the following is the list of

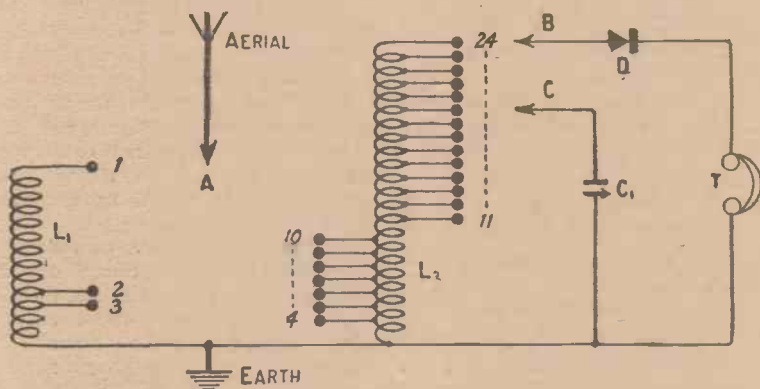

**Fig. 1.**—In this theoretical circuit  $L_1$  represents the plug-in coil and  $L_2$  the special tapped coil.

special coil covering the broadcast band when tuned by a variable condenser, while the reception of 5XX is made possible by the addition of a loading coil.

In the present receiver the design differs somewhat from these lines, in that a special coil is used for long-wave reception, while the local station is tuned in with a plug-in coil as the inductance.

**Variation in Circuit**

Actually, either the local or Daventry station may be received when using plug-in coils, but it is primarily intended that the long-wave station be received only when using the special coil. Further, it is possible to employ either direct or auto-coupling when using plug-in coils for either short or long waves, or, on the other hand, auto-coupling by means of the

**Use of Clips**

Three clips are used in the receiver, and by arranging these in a suitable manner it is possible to obtain the three different arrangements as shown in Fig. 2. The clips are indicated by the letters A, B and C, and in the first arrange-

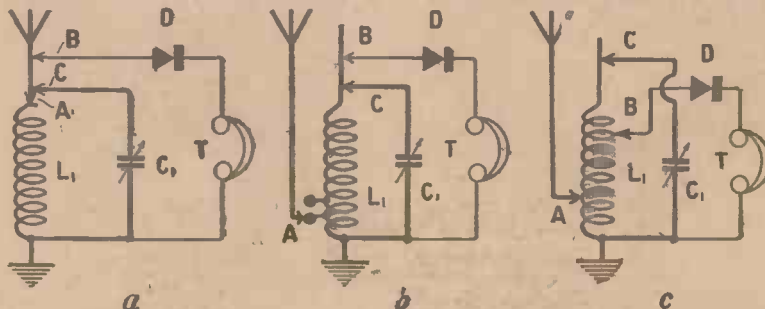

**Fig. 2.**—Three different arrangements are made possible in this receiver by suitably arranging the clips.

components and materials which are necessary. The names of the manufacturers or their trade marks follow upon the details of the components mentioned for the benefit of those who wish to duplicate the set as illustrated. It will be understood, however, that other makes of equal efficiency and values will be found as efficacious.

One ebonite panel, measuring 9 ins. by 10 ins. by  $\frac{1}{4}$  in. ("Trelleborg," F. W. Lowenadler).

One cabinet to take panel as above, with baseboard, 9 ins. by 10 ins. by  $\frac{1}{2}$  in. (W. H. Agar).

One variable square law, "Low-loss" condenser of .0005  $\mu$ F capacity ("Utility," Wilkins & Wright, Ltd.).

One crystal detector (Radio Communication Co., Ltd.).

One "Three-step" coil former, fitted with brackets ("Magnum," Burne Jones & Co., Lt 1.).

Four terminals, marked "aerial," "earth" and "phones" (2) (Belling & Lee, Ltd.).

One pound No. 22 d.c.c. wire.

One coil-holder for baseboard mounting.

Two right-angle brackets.

Three clips (two by S. H. Collett and one by Peto-Scott Co., Ltd.).

3 ft. rubber covered flexible wire.

2 ft. No. 16 "Glazite" wire.

Four 4BA screws and nuts.

Four wood screws.

**The Circuit**

The theoretical circuit arrangement of the receiver is shown in

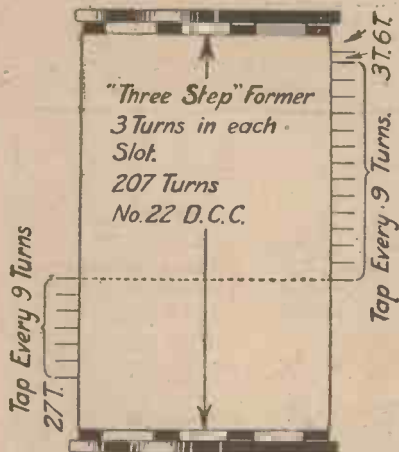

Fig. 3.—The tapping points are indicated in this diagram.

Fig. 1, where  $L_1$  represents the plug-in coil and  $L_2$  the special coil; the three clips are shown as A, B and C, and are used for making the various connections.

It will be easily seen that if we connect the aerial to 1, and the earth to the point "earth," we are making use of the coil  $L_1$ . This coil in the present receiver is a plug-in coil and by connecting the two clips B and C to the aerial end of the coil we have the direct-coupled arrangement of Fig. 1a.

This circuit will be found suitable

for the reception of both the local station and 5XX, the coils for the local station being either a No. 35 or 50; while for 5XX a No. 150 or 200 should be used.

**An Auto-Coupled Circuit**

If now we change the plug-in coil to one of the X type and still connect the clips B and C to the top end of the coil, but with A connected to one of the two tappings provided on these coils, then the arrangement becomes an auto-coupled circuit as in Fig. 2b.

Coils for use with this alteration of the clips are, for the broadcast band a No. 60X coil, and for Daventry a No. 250X coil.

**Using the Special Coil**

In the next arrangement we make use of the home-wound coil,  $L_2$  for the reception of the long-wave station only, and here the clip A should be connected to any of the points, 4, 5, 6 and so on, while the clip C should be connected to the point 24, and B to any one of the points between 11 and 24, according to results.

**Winding the Coil**

The special coil consists of 207 turns of No. 22 S.W.G. d.c.c. wire wound upon a "three-step" coil former. Three turns are wound in each slot, making tappings at the points indicated in Fig. 3.

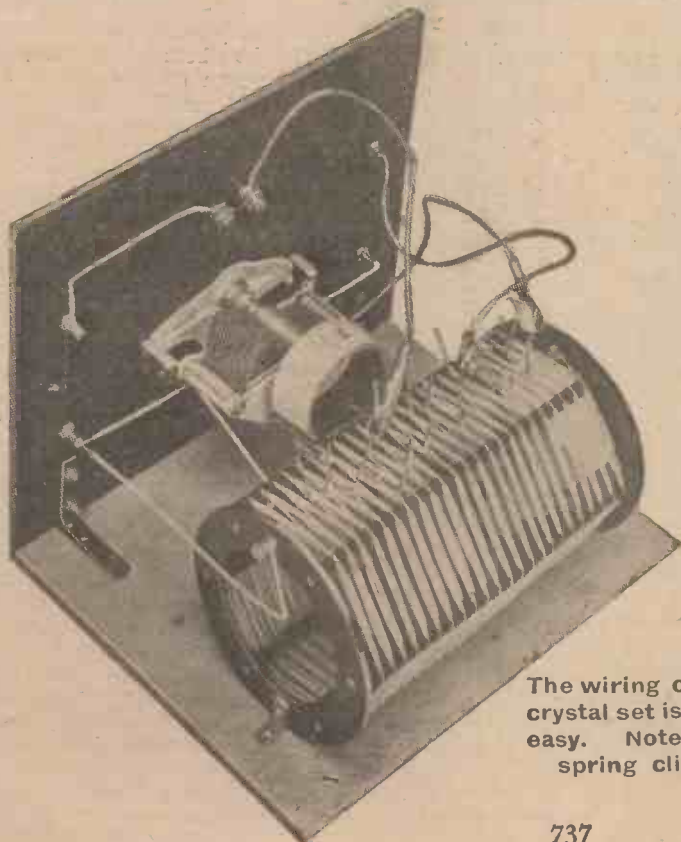

The wiring of this crystal set is quite easy. Note the spring clips.

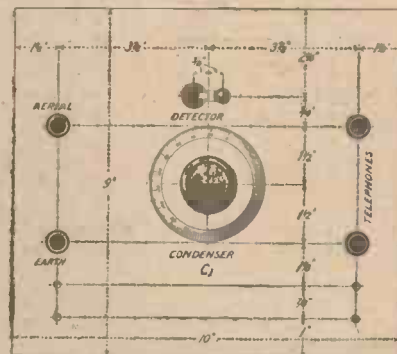

Fig. 4.—Front of panel details.

Should readers not feel inclined to wind their own coils, these may be obtained ready wound from the firms supplying the formers. The tappings are made by making small loops on the wire during the process of winding, and twisting them together, the tappings being slightly staggered.

**The Panel and Baseboard**

Excluding the winding of the coil just mentioned, the construction of the receiver is extremely easy. The panel should first be drilled in accordance with Fig. 4,

and then fitted to the baseboard by means of the two brackets. After this work has been done, the components should be mounted upon both the panel and baseboard. As regards the coil-holder

means of small wood screws and the small brackets provided with the former.

Wiring the Set

The connecting up of the com-

ponents in particular that the socket of the coil-holder ( $L_1$ ) is fitted with a projecting wire for the purpose of giving a suitable contact point for the clips when using direct or auto coupling with plug-in coils. Neglect to connect this wire to the socket of the coil-holder will result in the tappings on the X coil being at the wrong end of the coil when using auto-coupling as in Fig. 1b.

Operating the Set

After the receiver has been completed, connect the aerial to the terminal marked "aerial" and the earth to the terminal marked "earth."

The clips should now be arranged in accordance with the circuit it is desired to use and in compliance with the instructions previously given. A suitable coil, if plug-in coils are being used, should be inserted in the coil-holder, when, after adjusting the crystal detector, tuning is carried out by means of the variable condenser.

Using the home-made coil, the clips should be arranged as previously explained, with the aerial and earth still connected as before. With the clip A connected to, say, the tenth tapping counting from the end of the coil which is connected to earth, the clip C at the last turn of the coil, and clip B at the same point, the Daventry station should be tuned-in at the best possible strength, whereupon the position of the clip A should be varied, each time retuning upon the condenser, until the maximum signal strength is obtained (not forgetting that your first choice may, after all, prove to be the best!).

The next operation is to move the clip B downwards, one tapping at a time, and retuning upon the condenser with each move, until the loudest results are again obtained.

What you may Expect

When connected to an indifferent aerial in S.E. London, 2LO is received at good strength with either the direct or auto coupled methods, using plug-in coils. Similarly, 5XX is also received at average strength when using the same methods with suitable coils of the plug-in type.

Using the home-made coil for the reception of the Daventry station upon the same aerial, a good increase in signal strength is obtained over either of the plug-in coil methods referred to above.

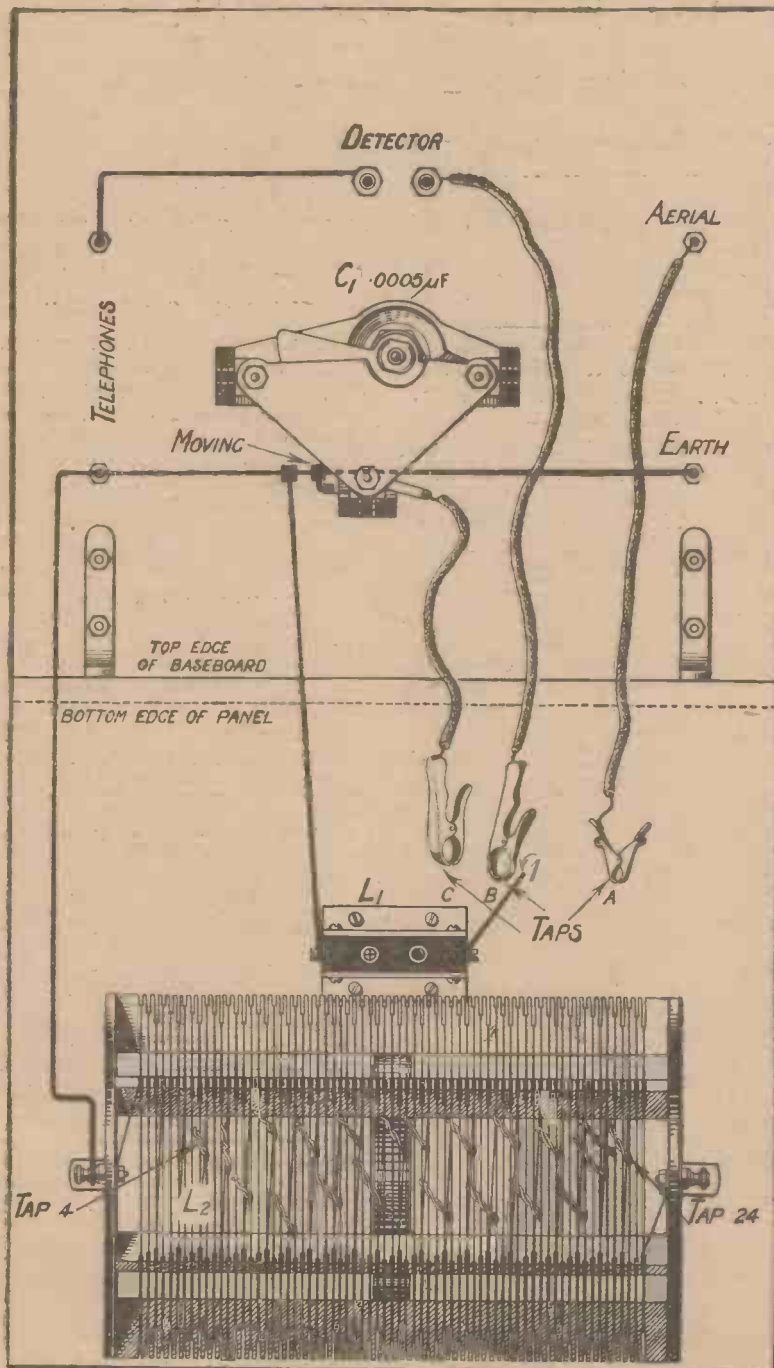

Fig. 5.—The wiring details and layout are made quite clear by reference to this diagram.

for the plug-in coil ( $L_1$ ) it is advisable to mount this upon the baseboard before securing the home-made coil. This latter may then be screwed to the baseboard by

components (see Fig. 5) is carried out with No. 16 "Glazite" wire with the exclusion of those points which are fitted with flexible leads terminating in clips. It should be

# The Importance of Valve Selection and the Effect on Selectivity

By the Staff of the Radio Press Laboratories.

An interesting article giving actual comparisons between several valves from the point of view of selectivity and signal strength.



ONE is often asked the question as to which is the best type of valve to use, and it is very difficult to answer unless something is known of the design of the receiver in which it is proposed to use the valve. There really is no "best" type of valve that will efficiently perform all the various functions required, and that will work equally well in all designs of receivers.

of valves in a selective and sensitive receiver. These considerations will be based on some measurements taken with the simplest possible circuit consisting of one high-frequency valve and a detector valve, without any reaction.

Capt. H. J. Round, in an article on "Some Further Notes on Interval Connections" in *Wireless Weekly* for November 18th, 1925, discussed the importance of considering valve resistance in the design of valve circuits. The extent to which a valve can influence the

L, as shown in Fig. 1C we place it across only half the coil as indicated in Fig. 2, the resistance must be equal to only  $\frac{1}{4} R$  if the damping in the circuit is to be the same. If the resistance is across a quarter of the coil, its value must be  $\frac{1}{16} R$  and so on.

### Valve Resistance or Impedance

Now a valve under working conditions has a definite resistance or impedance between its anode and filament terminals. This resistance  $R_0$  depends to a large extent on the closeness of the turns in the grid spiral or mesh, and also on the length and distance apart of the electrodes. A valve whose grid has a large number of turns per cm. length will have a very high resistance or impedance compared with a valve with a very open spiral grid. Different types of valves may have resistances varying from 2,000 to 50,000 ohms or more.

### Damping caused by the Valve

When a valve is connected in a circuit, as shown in Fig. 3A, it has a very definite damping effect on the oscillatory circuit  $L C$ , which is the output circuit of the valve. As far as damping is concerned the valve can be replaced by a resistance  $R_0$  connected across this oscillatory circuit and equal in value to the valve resistance or impedance (Fig. 3B).

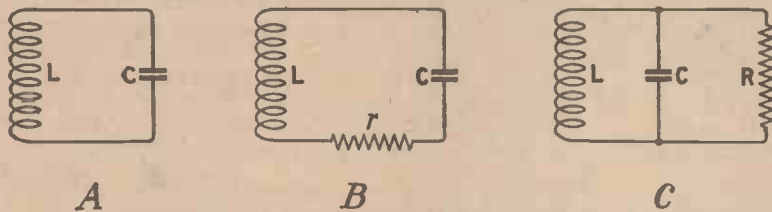

Fig. 1.—The H.F. losses in L and C can be represented by equivalent resistances  $r$  or  $R$ .

### Sensitive and Selective Receivers Using Suitable Valves

The present day highly sensitive and selective receivers must be designed to use definite types of valves. The valves, of course, need not be of the same manufacture, provided their general characteristics are the same. Valves for use with such sets should be definitely recommended by the manufacturer or designer of the receiver, otherwise the results will not be found to come up to expectations.

Of course there are receivers in use which appear to work equally well with almost any type of valve. Such receivers, however, cannot be efficient, as sacrifices must necessarily be made in order to minimise the bad effects of the different general characteristics of the valves.

### Using Unsuitable Valves

In this article it is proposed to outline some of the possible consequences of using unsuitable types

possible selectivity of a circuit and also its resultant amplification is not always realised, and it is thought that a few actual measurements may help to demonstrate the importance of this problem.

### Damping of a Circuit

The damping of a simple oscillatory circuit, as shown in Fig. 1A, depends on the high-frequency resistance of the inductance  $L$  and also of the capacity  $C$ . These high-frequency resistances can be represented either by a comparatively small resistance  $r$  in series with the circuit as shown in Fig. 1B, or a comparatively high resistance  $R$  in parallel with the circuit, as shown in Fig. 1C. Referring to Fig. 1B, the damping is increased by increasing the resistance  $r$ ; while in the case of Fig. 1C an increase in the resistance  $R$  reduces the damping.

If instead of placing a resistance  $R$  across the whole of the inductance

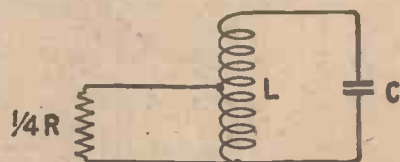

Fig. 2.—A resistance  $R/4$  across half  $L$  is equivalent to a resistance  $R$  across the whole of  $L$ .

### Relation between Valve and Circuit Resistances

The increase in damping of the circuit when the valve is connected

across it depends, of course, on the relative values of the high-frequency resistance of the circuit and the valve resistance. We have seen that the high-frequency resistances of the inductance and condenser can be considered as equivalent to a resistance  $R$  in parallel with the whole of the inductance  $L$ . If this resistance is large compared with the valve resistance, then the introduction of the valve across the whole of the circuit inductance will cause a very serious increase in the damping. Therefore, the greater the efficiency of the oscillating circuit  $L C$ , the more serious will be the effect of this valve damping. For example, in quite a normal type of circuit the damping caused

were thus negligible. As some form of rectification was necessary for measurement purposes, it was

of 10,000 kilocycles. This tendency to generate very high-frequency oscillations is of great importance

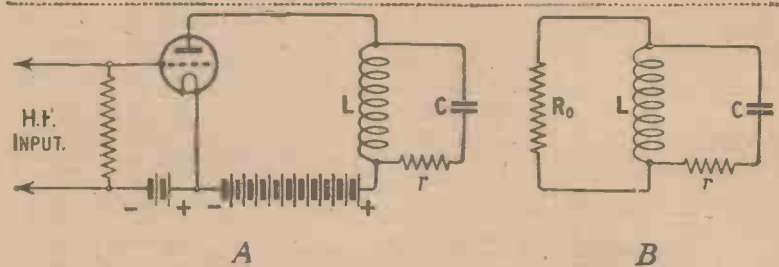

Fig. 3.—The resistance  $R_0$  is equivalent to the valve resistance across the  $L C$  circuit.

thought advisable to use "anode current rectification" so as to avoid the damping which would occur if

in high-frequency amplifier design, and will be discussed in a separate article at a future date.

**The High-Frequency Transformer**

The tuned H.F. transformer was wound on a grooved hexagonal former of the low-loss type (9 cms. between corners and 18 cms. long) with the primary and secondary windings interleaved. The primary or anode winding consisted of 56 turns of No. 22 D.S.C. solid copper wire, while the secondary or grid winding consisted of the same number of turns of 30 D.S.C. solid copper wire. The anode circuit was tuned by a variable air condenser. The conditions were thus similar to those found in the first stages of a perfectly neutrodyned high-frequency amplifier—that is no reaction and no grid current damping.

**Resonance Curves for Different Valves**

The comparative resonance curves for different valves were determined by varying the frequency of the oscillator and measuring the current differences in the anode circuit of the rectifier. Of course, as the frequency of the

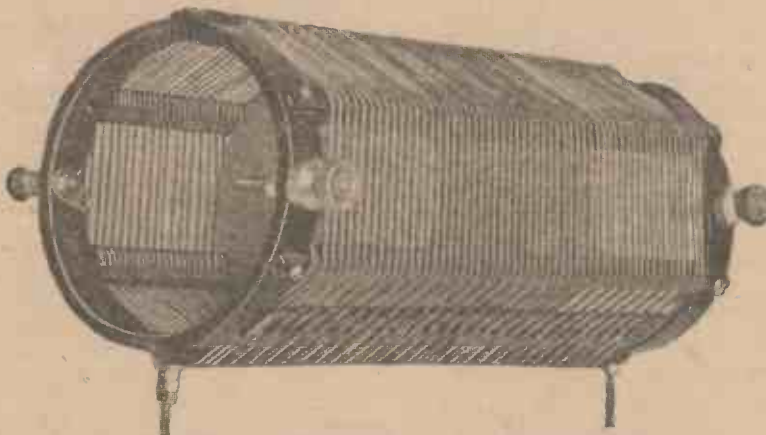

A photograph of the special H.F. transformer used in these experiments.

by a valve across the circuit may easily be ten times that caused by the ordinary high-frequency resistance of the circuit. Only in a very high resistance circuit would the effect of the valve be negligible as far as damping was concerned.

**High Resistance Valves**

It would seem from the statements made above that from a selectivity point of view it is essential to use a valve having the highest possible resistance or impedance. This is true up to a point, but as valves with high resistances require a greater anode voltage for their operation, there is obviously a limit to the valve resistance that can be used in practice.

**Comparisons of some different Valves**

A number of valves with different resistances and amplification ratios were compared in the circuit shown in Fig. 4. The grid circuit was untuned and consisted of a loop of wire coupled to a valve oscillator, the frequency of which could be varied. Stray reaction effects

cumulative grid rectification was employed.

**High-Frequency Oscillations**

Another precaution found necessary was the introduction of a small high-frequency choke connected directly in the anode lead

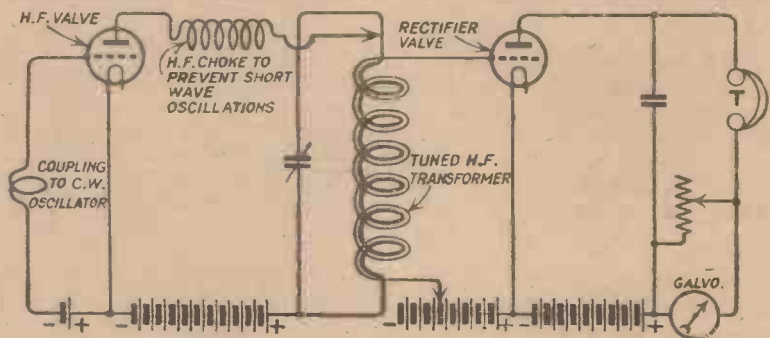

Fig. 4.—Different H.F. valves employed in this circuit greatly affect the selectivity.

of the high-frequency valve. Without this it was found that the circuit was liable to oscillate at a very high frequency of the order

oscillator is increased, there is an increased voltage induced between the grid and filament of the H.F. valve. This variation, however, was

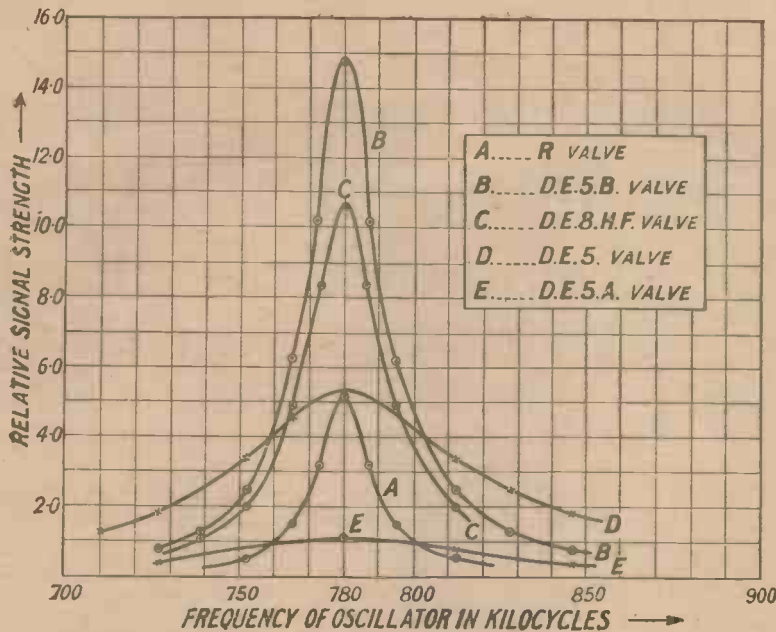

Fig. 5.—Curves showing the effect of different types of valves on the selectivity and sensitiveness of the circuit.

small over the working limits of this test so that it can be neglected.

**Selectivity**

For the purpose of comparing the selectivity of the circuit when using different valves, the selectivity has been defined as the percentage of detuning of the oscillator required to reduce the measured signal strength to half its resonant value. The appended table gives the comparative figures of signal strength and selectivity for valves of different resistances and amplification ratios, while the curves of Fig. 5 show the actual resonance curves. It will be seen that under the conditions of the test, the valve with the highest impedance or

TABLE SHOWING THE RELATIVE SIGNAL STRENGTH AND SELECTIVITY WHEN VALVES OF DIFFERENT CHARACTERISTICS WERE USED IN A HIGH-FREQUENCY CIRCUIT.

Valve Type.	Impedance, $R_0$ , Ohms.	Amplification Ratio, $\mu$ .	Relative signal strength at resonance.	Selectivity or percentage detuning for half resonant signal strength.
A. (R.) .. ..	31,000	9	5.2	1.16%
B. (D.E.5 B.) ..	30,000	20	13.8	1.56%
C. (D.E.8 H.F.) ..	25,000	16	10.6	1.80%
D. (D.E.5) .. ..	8,000	7	5.3	5.12%
E. (D.E.5 A.) ..	4,000	3.5	1.1	6.15%

resistance gave the best selectivity, although not the best signal strength. Two valves which gave the same signal strength gave entirely different values of selectivity.

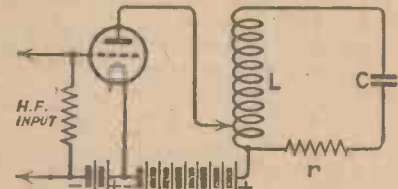

Fig. 6.—Selectivity and signal strength are often improved by using this circuit.

**Valve connected across part of the Tuned Circuit**

Connecting the high-frequency valve across part of the inductance, as shown in Fig. 6, has a very important effect on both selectivity and signal strength, but this question will be discussed in a later article, when the interesting results of some further measurements will be given.

Read the **WIRELESS CONSTRUCTOR**

Published on the 15th of the month.

Price 6d.

Full of Useful, Practical Information for the Home Constructor.



# MEASUREMENTS ON YOUR RECEIVER

By D. J. S. HARTT, B.Sc.

It is advantageous to measure the various currents and voltages in a receiving set, and this article indicates how such measurements can be made and the importance of the derived information.

**T**WO of the most useful instruments an amateur can possess are a milliammeter and a voltmeter, for by their use in a wireless receiver much valuable information may be obtained as to whether it is being operated correctly. It is proposed in this article to indicate what types of measuring instruments are best suited for this purpose and to give examples of some of their many applications.

### A Wise Policy

In the first place it is a wise policy to purchase only good-class instruments of the moving coil type, which are provided with a large open scale to facilitate accurate observations. The measurements usually required in a valve receiver are the anode current, filament current, H.T. battery voltages, the

voltages applied to the filaments of the valves, grid-bias voltage, and the L.T. battery voltage. In order to be able to measure all these quantities satisfactorily a number of instruments would be required to cover the various ranges, but for reasons of economy it may be advisable to obtain one of the multi-range instruments.

### Multi-range Instruments

This type of instrument can be so designed that by connection to various terminals it may be used as a voltmeter, milliammeter and ammeter, the necessary resistances and shunts to make this possible being either incorporated within the instrument or supplied for external connection. An instrument possessed by the author has a 5-in. anti-parallax scale and is provided with seven terminals,

giving the following ranges: 0-500 microamps., 0-10 milliamps., 0-100 milliamps., 0-1 amp., 0-5 volts, and 0-100 volts.

It is, of course, possible to obtain voltmeters giving, say, two ranges, such as 0 to 10 volts, and 0 to 100 volts, or 0 to 12, and 0 to 120 volts; and if the amateur provides himself with a good instrument, and also a milliammeter reading from 0 to 10 or 0 to 20 milliamps., he will be well equipped to carry out the most useful measurements.

### High Resistance on Voltage Ranges

It will be obvious that an instrument for measuring voltage should have a high resistance, since it is connected in parallel with the part of the circuit across which it is required to find the difference of

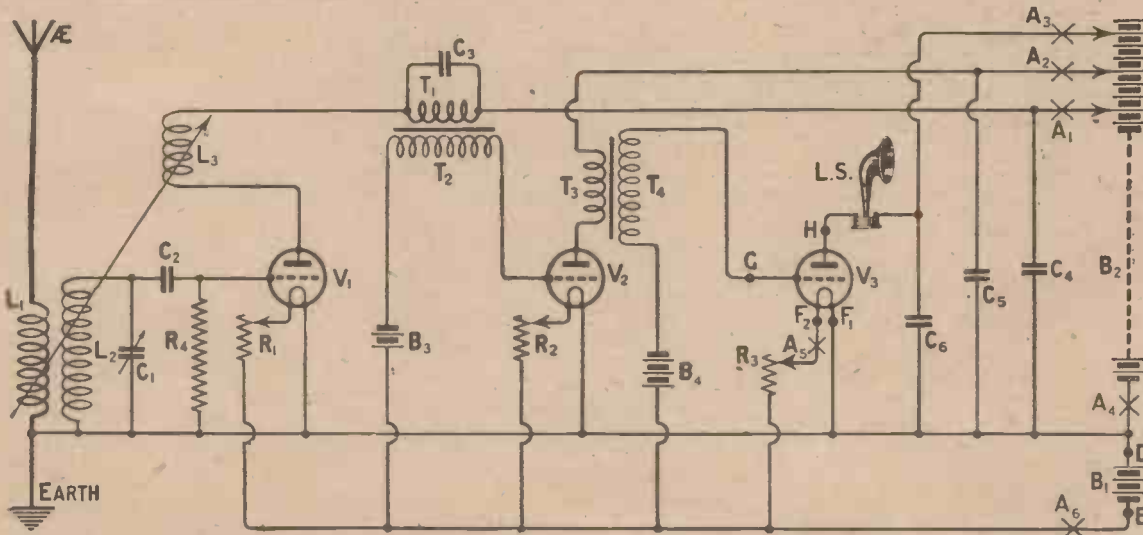

Fig. 1.—A conventional circuit for a receiver on which useful measurements can be made.



potential, and should, therefore, take as small a current as possible, so as not to disturb the conditions in the rest of the circuit. The resistance of the multi-range instrument referred to above is 33,333 ohms on the 100-volt range, so that the current taken by the instrument when connected across the terminals of a 100-volt H.T. battery is only 3 milliamps., which is small enough to ensure that the voltage of the battery is not affected. If this resistance was low the current taken would be unduly large, thus producing a fairly large load on

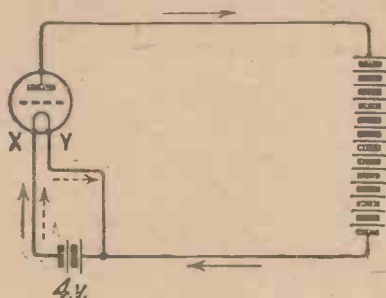

Fig. 2.—The arrows indicate the paths taken by the electrons in the filament and anode circuits.

the H.T. battery; it will be seen, therefore, that the resistance of the voltmeter on the higher range should be as high as possible, and this should be borne in mind when purchasing the instrument.

On the other hand, an instrument for measuring current is connected directly in the circuit through which the current is flowing, and should have a low resistance so that the value of the current flowing is not sensibly changed.

**Advantage of Separate Instruments**

There is, of course, an obvious advantage in having a separate milliammeter and a voltmeter, since voltage and current can then be measured at the same time, but the expenditure on two such instruments will probably be as great as for a multi-range instrument of the same standard which would give a larger number of measuring ranges and therefore have a wider general application.

Turning now to the uses of such instruments, let us consider a typical receiving circuit such as is given in Fig. 1, which shows a conventional arrangement of a detector valve, and two stages of transformer coupled note magnification, with separate H.T. tapplings for each valve and provision for grid-bias on  $V_2$  and  $V_3$ .

**Applications in a Receiver**

One of the first adjustments that should be made is to ensure that the valves are operated at the correct filament temperature, and this may be done by connecting the voltmeter across the filament legs of each valve in turn and adjusting each rheostat so that the voltage across the filament is in accordance with the data issued by the valve manufacturer. The terminal marked + on the instrument, for instance, should be connected to the positive filament leg  $F_1$  and the other terminal to  $F_2$ , and for this purpose it is convenient to fit some type of spring clips to the leads from the instrument. By measuring across  $F_1$  and  $F_2$  in this way the working filament voltage on valve  $V_2$  is obtained, and to ensure a normal life from the valve this should not exceed that given by the makers. If it is possible to reduce the voltage slightly without any adverse effect on signals, this is all to the good from the point of view of the life of the valve.

**L.T. Battery Voltage**

The voltage of the accumulator is measured across its terminals  $D$  and  $E$ , the positive of the voltmeter being connected to  $D$ . This reading should always be taken while the accumulator is supplying current to the valves and the important point to observe here is that this voltage should never be allowed to drop below a certain minimum value which may be taken as 1.85 volts per cell. In fact, if you are to obtain the maximum efficiency and long life from the accumulator, it is a wise precaution always to have it recharged immediately the voltage on load approaches this value, and not to delay charging until the very minimum has been reached.

If valves of the .06 type are being used in a receiver it is important to keep a close observation on the state of the accumulator for the latter may still provide the necessary small current even when discharged past the safe limit, and if it is unknowingly left in this condition serious sulphating may set in and ruin it.

**Grid-Bias Voltage**

In the circuit shown in Fig. 1, the grid-bias voltage on the valve  $V_2$  is due partly to the battery  $B_4$  and partly to the drop in voltage across the filament resistance  $R_2$ ; the latter voltage drop is equal to the voltage of the L.T. battery minus the sum of the working

filament voltage and any voltage drop there may be in the leads constituting the remainder of the filament circuit for that valve. The existence of this voltage drop in the filament leads is a point which is often overlooked, although in a multi-valve receiver it may be quite appreciable. In order to obtain a reading for the total grid-bias voltage in the case under consideration the voltmeter should be connected across the points  $F_2$  and  $G$ , with the positive terminal of the instrument joined to the negative filament  $F_2$ . Should the filament resistance be connected in the positive L.T. lead the same procedure would apply and in this case the grid-bias voltage would be that of the battery  $B_1$  only.

**Adjustment of Grid Potential**

A useful rule to remember for guidance in determining the grid-bias to employ in L.F. amplifiers is that given by Captain Round, namely, to divide the H.T. voltage by twice the amplification ratio of the valve. The grid-bias battery may then be tapped to give a voltage nearest to the required value and a check on the voltage made as described above. It should be remembered that although a grid battery may show its full voltage when new, this is liable to drop after it has been in use for some time due to several causes, and a check on the voltage is desirable from time to time. A further note on the adjustment of the grid potential will be given later.

**Measurement of Filament Current**

Although a correct adjustment of the voltage applied to the fila-

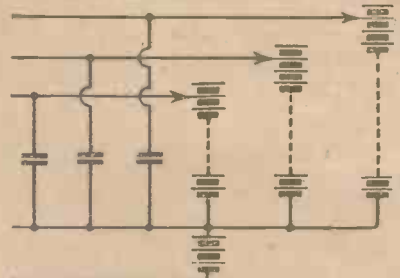

Fig. 3.—It is often necessary to use several small H.T. batteries as shown here.

ment is to a certain extent a safeguard against overrunning a valve, a knowledge of the actual filament current is often more desirable. This may be obtained by inserting the ammeter in the lead to the negative filament as at  $A_5$  in Fig. 1. To measure the total filament

current an ammeter of suitable range should be connected in the L.T. circuit at the point marked  $A_6$ . The reason for connecting the ammeter in the negative lead is interesting and may be explained by reference to Fig. 2. Here the negative end of the filament marked  $X$  is the point of lowest potential in the circuit and all potentials are measured with respect to this point. The end  $Y$  of the filament will therefore be 4 volts positive with respect to  $X$ . Now the electron flow which constitutes the anode current is from the filament through the valve, through the external circuit, and back to the filament along the negative lead, as indicated by the full line arrows, and is thus greatest from the negative end of the filament, becoming less along the length of the filament from  $X$  to  $Y$ . The electron flow from the negative of the filament battery, through the filament and back to the battery is shown with dotted arrows. It is thus seen that the positive lead carries only the latter current while the negative lead carries both. To obtain a true reading the ammeter should therefore be connected in the negative lead. In actual practical measurement, of course, the difference between the readings obtained in the negative and in the positive leads would not be noticeable with a bright-emitter valve, but would be appreciable in the case of the .06 amp. type.

**Using a Milliammeter**

We come now to the use of the milliammeter, and the circuit of Fig. 1 will again be taken in indicating its applications. One of its main uses is in measuring the anode current of a valve, and for this purpose the instrument should be connected in the H.T. plus lead to the anode of the valve. In Fig. 1  $A_1$ ,  $A_2$  and  $A_3$  indicate the points where these leads should be broken to measure the values of the anode current taken by  $V_1$ ,  $V_2$  and  $V_3$  respectively, and in these cases the instrument may be connected between the H.T. + tapping on the battery and the appropriate H.T. terminal on the set, the plus terminal of the instrument being in all cases connected to the tapping on the H.T. battery. The sum of these three readings will give the total current taken from the H.T. battery and this value will also be indicated by a milliammeter of suitable range placed in circuit at  $A_4$ . It should be noted, however, that the total load is not uniformly distributed throughout the battery, for the portion between the negative and  $A_1$  is supplying current for all three valves, that between  $A_1$  and

$A_2$  for two valves, while the cells between  $A_2$  and  $A_3$  supply only one valve, so that the life of the cells at the negative end of the battery will be less than for those at the positive end.

**The Total Anode Current**

It is important to see that the total load is within a safe limit for the size of the H.T. battery in use; about 5 milliamps. is a safe maximum to allow for the ordinary small type of H.T. battery if these are to be used continuously over long periods. In multi-valve receivers where the total anode current may be between 10 and 15 milliamps. or even more, it is wise to provide a battery having the large size cells, or else arrange that several of the smaller batteries are

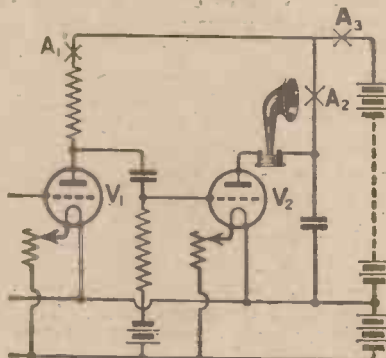

Fig. 4.—An amplifier circuit indicating suitable anode current measurement positions.

connected up as shown in Fig. 3, where each battery may supply the anode current for either one or two valves according to their type.

In cases where there is only one H.T. tapping for two or more valves, such as is shown in the portion of the amplifier circuit given in Fig. 4, it is necessary to break the anode circuit of  $V_1$  at the point marked  $A_1$  in order to measure the anode current of that valve; similarly, the milliammeter should be inserted at  $A_2$  to take a reading of the anode current of the valve  $V_2$ , while in the position marked  $A_3$  the total anode current of the two valves would be indicated.

**An Aid to Tuning**

When the milliammeter is connected at  $A_1$ , in the anode circuit of the detector valve (Fig. 1) it will record the value of the steady anode current and will give a visual indication by a movement of the needle when the circuit  $L_2C_1$  is brought into tune with an incoming signal. Suppose, for instance, that the local

station is being tuned in; as the condenser  $C_1$  is slowly rotated, at a certain point the milliammeter reading will begin to decrease, reach a minimum reading and then increase back to the normal figure. When the reading is at a minimum the circuit is accurately tuned, and this indication enables one to make more exact adjustments than would be possible by aural observation alone.

**Correct Operation of L.F. Valves**

When the milliammeter is connected in the anode circuit of either of the L.F. valves and signals are being received, the needle should remain sensibly steady. If any considerable fluctuation occurs it indicates that the valve is being operated incorrectly, as will probably be evidenced by distortion in the loud-speaker, and attention should then be paid to the adjustment of the H.T. and the grid-bias voltages. With a suitable value of H.T. voltage it should be found that for a certain value of grid-bias the swinging of the needle is practically negligible. The grid-bias voltage should be adjusted to the maximum possible consistent with distortionless reception, and in this way economy in plate current is effected.

**A False Reading**

Although a high-resistance voltmeter of the type indicated previously is suitable for measuring the voltage of the H.T. battery, it must be pointed out that it cannot be used to measure directly the actual voltage applied to the anode merely by connecting across the points  $H$  and  $F_2$  in the circuit of Fig. 1, for the following reasons:—

In the steady state there is a definite anode current flowing through the loud-speaker, and there will consequently be a certain voltage drop across the resistance of its windings. The actual voltage applied to the anode will thus be equal to the H.T. battery voltage, minus this voltage drop. Now, when the voltmeter is connected across the points  $H$  and  $F_2$  we have placed the resistance of the voltmeter in parallel with that of the valve, and the resultant effective resistance will be lower than that of either of them, and consequently the anode current will increase. This will produce a larger voltage drop across the resistance of the loud-speaker, and consequently the voltage on the valve will be decreased. The result, therefore, is that the voltmeter will indicate a voltage slightly lower than that actually applied to the anode in the case considered.

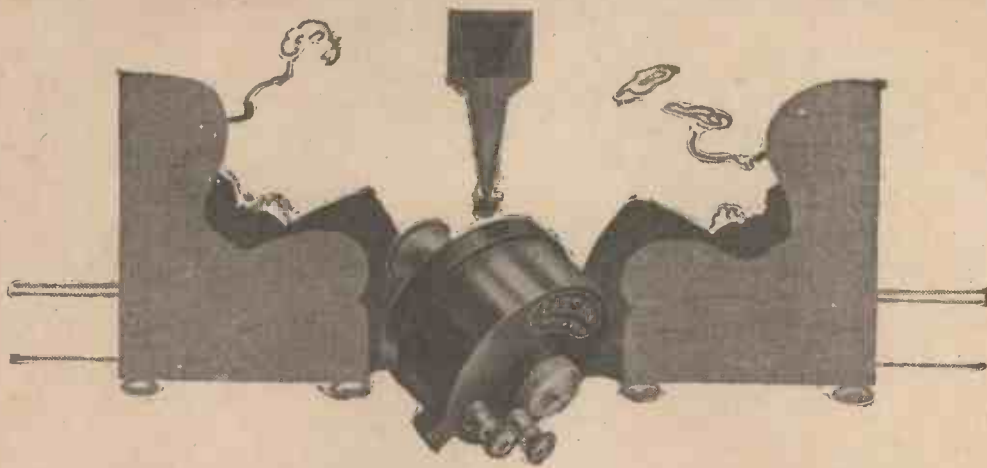

## Build your own Loud Speaker and discard your headphones

Gone are the days of troublesome 'phones. The Lissenola brings loud speaker convenience to every home at a record in low price. For 13s. 6d.—less than the cost of headphones—you can buy the Lissenola, which only needs the addition of a horn to make it a powerful, full-sized instrument yielding results equal to an expensive loud speaker.\*

Compare the price last. Make this test before buying: Go to your dealer—ask him to put on the best loud speaker he has in stock—then use the same horn on the Lissenola, and see if you can notice any difference.

You can build a horn yourself—with each Lissenola we give you full-size exact patterns and clear instructions how for a few pence you can build a big horn of proved efficiency. The illustration above shows the effective horn you will build. It can be covered with fancy paper or painted so as to resemble a factory-made article.



In addition, the Lissenola will fit the

tone-arm of any gramophone, instantly converting it into a radio loud speaker.

By using the Lissen Reed (sold separately for 1s.) the Lissenola will carry a cone or any other diaphragm working on the reed principle. You can quickly make a paper diaphragm yourself.



\*The secret of the Lissenola's remarkable efficiency rests in the effective manner in which the electro-magnetic sound-reproducing system is concentrated.

Your dealer will gladly demonstrate and supply—or post free by return from the makers—price 13/6, or with Lissen Reed 14/6.

## BUY THE LISSENOLA and build your own Loud Speaker

Lissen Limited, 20-24, Friars Lane, Richmond, Surrey

\*Phone: Richmond 2235 (4 lines).

\*Grams: "Lissenium, 'Phone, London."

L.11

OURSELVES — AND THE ELECTRICAL IMPULSE





# Brandes

"That radio contrivance of yours, Smith; it talks very naturally. The fellow holding forth on what to plant in the garden might well be in this room."  
 "Ah yes! It's a Brandes; an old friend of mine. Always did sound clearly and well. Thank Heaven the fellow is not in the room, anyhow. It too easily reminds me that my wife will probably lend her moral support to my doing some gardening on Sunday morning."  
 "Yes, but why is it so appreciably better than most? I had dinner with Brown-Jones last week. His port is excellent, but his radio is excruciating; I wanted to throw things."  
 "Well, these Brandes fellows claim that they build their instruments from an expert knowledge of radio acoustics."  
 "I don't know what radio acoustics is from Adam."  
 "My dear Jackson, of course you don't. Neither do I, technically."  
 "Well, tell me what you know about it."  
 "You perhaps know that acoustics is the science of sound?"  
 "Well, ye-es!"

"Right! Radio acoustics is the science of transforming the electrical impulse into audible sound."  
 "Do you mean that the electrical impulse is the electrical energy which carries the transmitted power from the studio to the receiver?"  
 "Precisely!"  
 "And that the Brandes instrument is constructed with the correct scientific elements for a most able transformation into audible sound?"  
 "As you say, dear fellow! Brandes are thoughtful radio builders and seventeen year's intimate association with the electrical impulse must have given them a lift above the others."  
 "Well, that youngster of mine is pestering me for a loud-speaker—I'll see that it's a Brandes."  
 "I should! You have heard mine—ah! the Savoy Bands coming through. Don't give John any more whisky. He'll probably want us to fox-trot with him."  
 "No sir! On the contrary, I am thinking of investing in a Brandes."

MATCHED TONE HEADPHONES      THE TABLE-TALKER      THE BRANDOLA      AUDIO TRANSFORMER

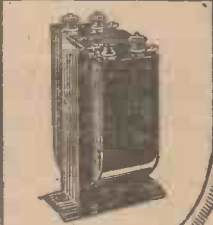
 <p>20/6</p>	 <p>30/6</p>	 <p>90/6</p>	 <p>17/6</p>
---	---	---	---

Send for particulars of our Dealers Service

BRANDES LIMITED  
296 Regent Street W.1

EXPERTS IN RADIO

ACOUSTICS SINCE 1908

27-232

Service Advertising

## Letters from our Readers

### The "Harmony Four" and the "Special Five"

SIR,—I am pleased to contribute my me-d of praise in regard to the above two circuits recently published in MODERN WIRELESS, and must specially congratulate Mr. Harris on the remarkable clarity, absence of background, and purity of loud-speaker reproduction obtainable from the "Harmony Four," described in the September, 1925, issue of MODERN WIRELESS.

This set was constructed exactly in accordance with the diagram, the valves used being "Wuncell" in H.F. stages, "Triotron" as detector, and "Wuncell" power valve in last stage.

With regard to the "Special Five," described by Mr. Harris in MODERN WIRELESS for November, 1925, I have departed from the design in several instances, although the spacing and placing of the wiring and components are in accordance with the blue print.

In the first instance, for the purpose of easy calibration of the set, a Colvern Selector Condenser .0005 was utilised, with an Index Counter (1 to 10). Owing to the vagaries of valves (even of the same make), two separate rheostats were fitted to the H.F. stages, whilst for the two L.F. stages, two "Igranic" (ratios 5 to 1 and 3 to 1) transformers were utilised.

With regard to the neutrodyne condensers, those used were the large Polar type, which have no locking nut. A "Lissen X" (60) coil and a 35 "Igranic" coil were fitted in the twin coil holders.

### Tuning

The local station was quickly tuned in direct on the loud-speaker, and after a few minutes Manchester was located; thence on, stations were approximately located by calculation, and after tuning with Nos. 2 and 3 condensers, brought in.

In the district in which I reside, the local station (some six or seven miles distant) is, on several nights each week, the victim of one and occasionally two Continental station heterodynes.

It has been found possible by careful operation of the neutrodyne condensers, sometimes one, some-

times both, to tune the heterodyne station in on the loud-speaker without touching the three main condensers, and the local station has disappeared into oblivion, there being apparently no ill effects from the local transmission on the Continental station output.

### Stations Received

Three weeks' study and operation of this set on the 250-550 bands only, produces the following results:—

Very good loud-speaker production on Continental stations with operating power of one or more k.w., at distances up to 700 miles; in some instances even low power stations at 400 to 500 miles produce similar results.

The B.B.C. main stations are, of course, obtainable at full loud-speaker strength.

In conclusion, I should like to congratulate MODERN WIRELESS and Mr. Harris in particular upon the production of a set which has high sensitivity and selectivity and exceptional power, and it is by far the most effective set that I have seen or operated, and, in my opinion, the Super Heterodyne has a strong rival therein.—Yours truly,

GEO. S. HEPTON, Jr.  
Hessle, E. Yorks.

### The "Simple-Tune Three"

SIR,—I feel I must write you to express my thanks and appreciation to Mr. John Underdown for designing "The Simple-Tune Three," details of which were published in the December, 1925, edition of MODERN WIRELESS.

I may say that I have experimented with many designs that have appeared periodically in MODERN WIRELESS, but this beats all, both in volume and clarity, also in performance generally. I have been able to tune in French and German stations on wavelengths in the vicinity of 300-600 metres at good loud-speaker strength with an aerial which is badly screened.

The B.B.C. stations are, of course, exceptionally good.

Daventry has to be detuned for comfort in an ordinary sized room.

I would like to mention that by having the .0005  $\mu$ F condenser in circuit signals are very poor—not good 'phone strength.

The components I used were not exactly as suggested by Mr. Underdown, but were all of good repute, the alteration being a Marconi Ideal transformer and a Sterling square-law geared condenser.—Yours truly,

E. MAURICE HOOK,  
Wainfleet, Lancs.

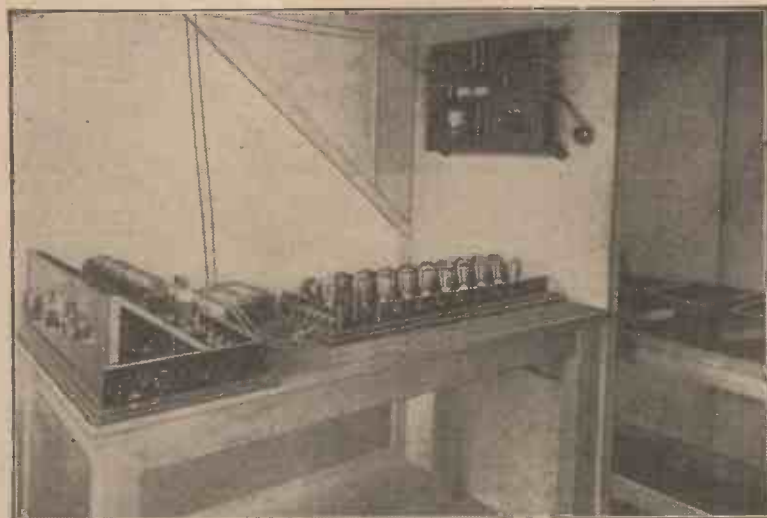

The sixteen valve installation presented to the London Hospital by the Igranic Electric Co., Ltd.

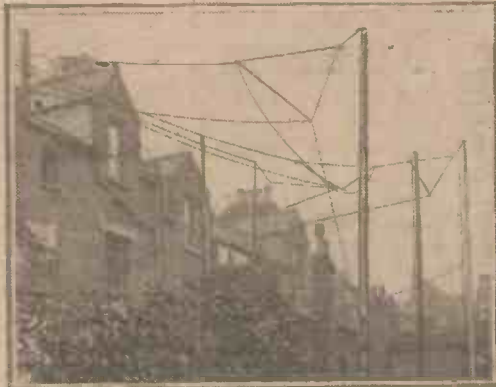

## Which is the best Aerial Circuit?

By G. P. KENDALL, B.Sc.

*Do not choose your aerial circuit without due consideration or the results will often prove disappointing.*

NOT so very long ago most of us had only one idea of a tuned aerial circuit, and that was one composed of a plug-in coil and a variable condenser, arranged either in series or in parallel. In the last twelve months or so, however, other methods of arranging the aerial circuit have made rapid strides, and probably something like half the sets now in use by home constructors embody some more elaborate scheme than the simple coil and condenser arrangement.

### Better Methods

Decidedly improved results can be obtained by the use of more elaborate tuning arrangements, and it is worth spending a little time acquiring a thorough knowledge of the various types of circuits, with their characteristics and particular degrees of suitability for different purposes. It is scarcely necessary to point out that different aerial tuning arrangements may suit different types of receivers in a very pronounced manner. For example, one of the difficulties of the design of an effective neutrodyne receiver is to arrange so that the damping of the aerial circuit shall be applied to the grid circuit of the first valve in a manner which is as nearly as possible constant over all the frequencies of reception. If this cannot be done, of course, it will prove likewise impossible to obtain an adjustment of the neutralising control which will hold good over the whole of the tuning range of the set.

### Single Circuit Tuning

Where only a fair degree of selectivity is desired, with the maximum of ease of construction and operation, probably the old arrangement of a single plug-in coil and a variable condenser either in parallel or in series with the aerial circuit has much to commend it.

Tuning is fairly flat with this form of circuit, and it is hopeless to expect to cut out a powerful local station with nothing more elaborate. For very simple sets, however, such as crystal receivers,

the arrangement is perfectly satisfactory in many cases, and a few notes upon its arrangement for the maximum signal strength may be useful.

### Series or Parallel

The question as to whether greater signal strength is obtained with series or parallel condenser can as a rule be settled in favour of the series condenser, but this will depend to some extent upon the particular aerial under consideration. It is therefore necessary to consider how the maximum of signal strength is obtained in each case.

When the condenser is in parallel, there is a perfectly definite and simple rule upon the matter ;

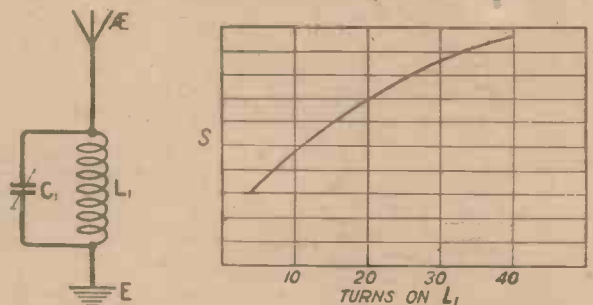

Fig. 1.—When the condenser is in parallel it is generally found that the larger the coil the better.

the larger the coil the louder will be the signals, provided that you can still tune to the frequency of the station which you desire to receive. In Fig. 1 will be seen a curve showing the relation in a typical case between signal strength and the number of turns upon the tuning coil, this curve being actually very similar to that which is obtained on carrying out the necessary measurements upon my own aerial.

### Effect of Turn Numbers

It will be seen that the signal strength rises steadily as the number of turns upon the coil is

# 3 Star Radio Performers



Popular with countless listeners everywhere

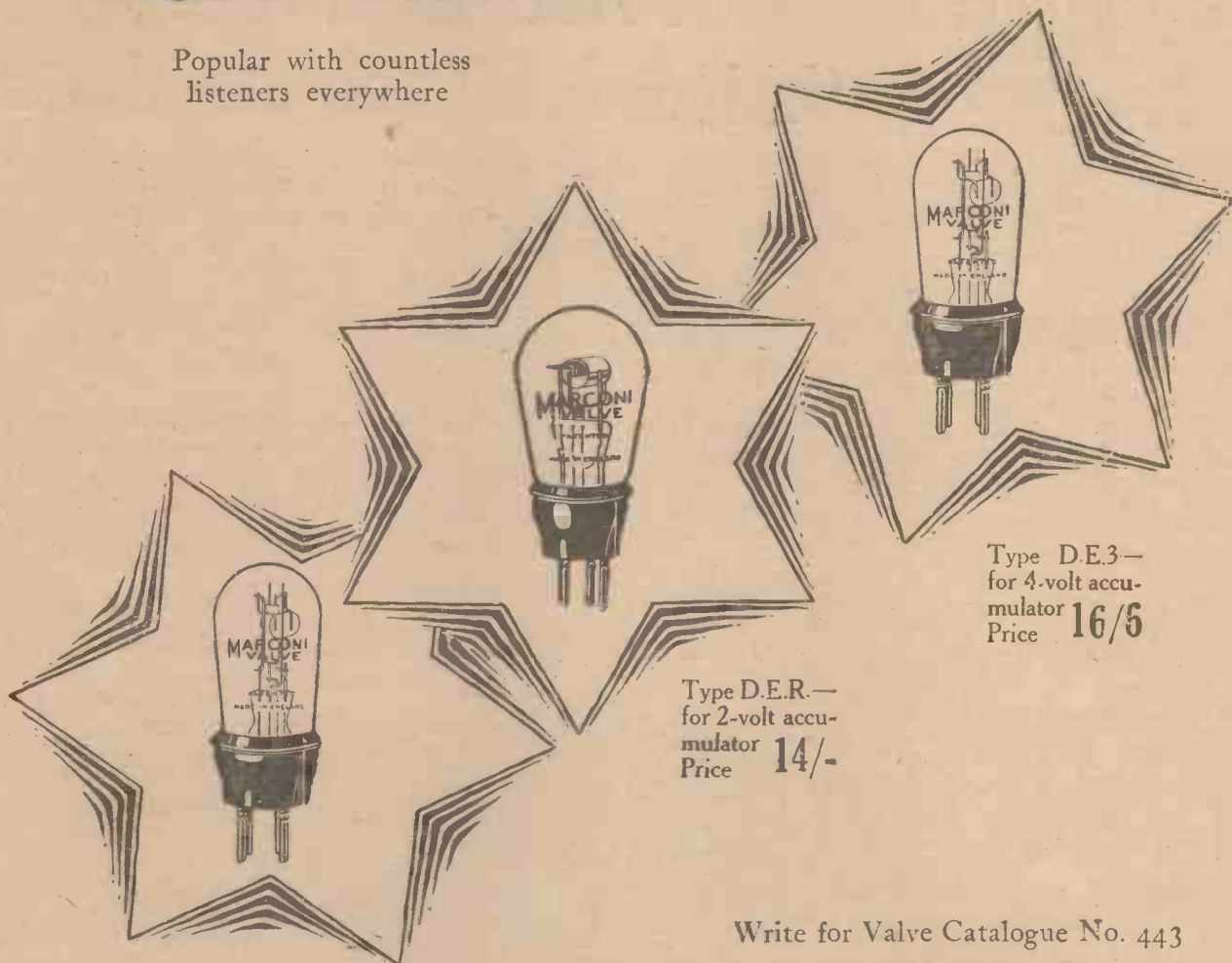

Type 2.D.E.—L.F. & H.F. for 2-volt accumulator. Price 15/6

Type D.E.R.—for 2-volt accumulator Price 14/-

Type D.E.3— for 4-volt accumulator Price 16/6

Write for Valve Catalogue No. 443

# MARCONI VALVES

IN THE PURPLE BOX

THE MARCONIPHONE COMPANY LIMITED

Registered Office: Marconi House, Strand, London, W.C.2    Head Office: 210-212 Tottenham Ct. Rd., London, W.1

Branches: Aberdeen, Bristol, Birmingham, Belfast, Cardiff, Cheltenham, Dublin, Glasgow, Leeds, Liverpool, Manchester, Newcastle, Nottingham, Southampton, Swansea.

# FADA Radio



## First with the "All-wave" Neutrodyne

Look to FADA RADIO for leadership—for being first in the radio field with any development that makes for better, easier, simpler reception.

Once again FADA RADIO have produced something which has never been done before—a *Neutrodyne* that covers the whole band of broadcast wave-lengths!

FADA RADIO simplicity is just as evident as ever in this new set. The turn of a dial—the throw of a switch—that's all you need to bring in any English or Continental station from 200 to 2,500 metres. And with it all, the wonderful FADA selectivity, clarity and volume.

This is the circuit that thousands of wireless listeners have been waiting for. It is sold in all the standard FADA RADIO cabinets. If your local dealer is not yet showing it, write us direct.

FADA RADIO, Ltd., 31, Kingsway, London, W.C.

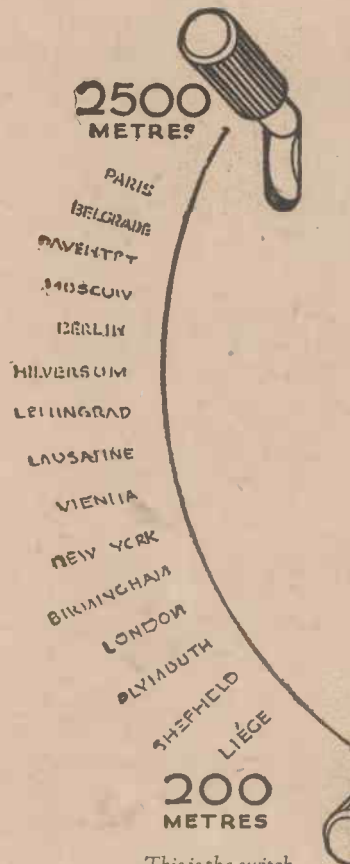

This is the switch that changes over from long to short waves—in one simple flick! It is incorporated only in FADA RADIO receivers.

Manufactured under Hazeltine Neutrodyne Patents granted in Great Britain.



The "long-short" set illustrated above is the 5-valve FADA RADIO receiver No. 175-AL otherwise similar to the FADA Neutrodyne. Retail at £45.

FADA RADIO LTD. 31 KINGSWAY LONDON W.C.2



increased, reaching a maximum with 40 turns; beyond which it was impossible to go without being unable to tune to the station which was being used for testing purposes (2LO). It will be seen that the curve is not a straight line, but falls off in steepness as the number of turns upon the coil is increased, and this is presumably due to the fact that the high-frequency resistance of the coil is rising considerably as the number of turns increases, so that the expected increase of signal strength is not fully realised. It will therefore be seen that there is a very simple rule which must be observed in using the parallel circuit:

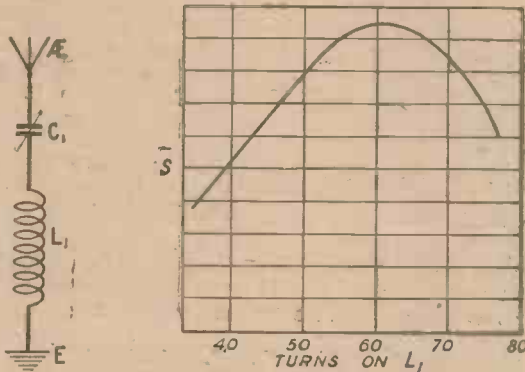

Fig. 2.—There is an optimum value for the aerial coil with series tuning.

use always as large a coil as possible, and you are assured of the maximum strength of signals.

**Series Condenser**

When the tuning condenser is connected in series, the state of affairs is somewhat different, since we have now two opposing factors. In the first place, it is desirable to use as large a coil as possible, for the same reason as before, namely, that as large a voltage may be developed across it as possible. On the other hand, if the coil is made too large, we shall only be able to tune down to the desired station by using an extremely small reading on the series condenser, and this in itself will have a serious adverse effect upon signal strength. If the experiment is carried out of plotting signal strength against the number of turns upon the coil, the result is, in a typical case, as seen in Fig. 2.

**Coil Variations**

It will be observed that as the number of turns is increased from 40 to 80 signal strength rises steadily to a maximum at about 60 turns and then falls again somewhat more rapidly when this point is passed. This fall is, of course, due to the fact that we are now working upon extremely small settings of the series condenser, and it is therefore necessary to realise that to obtain the best results the ideal to aim at is to use as large a coil as possible without going below 20 degrees on the average condenser scale. (A condenser of about .0005  $\mu$ F capacity is assumed.)

**A Safe Rule**

It is in reality no more difficult to choose a coil when the condenser is in series than when it is in parallel, provided that this simple rule is remembered, to the effect that 20 degrees upon the condenser scale should be regarded as the zero reading, below which one should never go. It is then easy to choose a coil which brings the reading down as near to this value as possible, without actually passing it.

**Simple Coupled Circuits**

Some very popular, and with certain reservations very effective, methods of tuning the aerial circuit are to be found in the various auto- or inductively-coupled schemes. Probably the most successful of these is that which has been called "aperiodic aerial tuning," consisting of a small winding in the aerial circuit very closely coupled to a secondary circuit, no special means of tuning the aerial being provided other than a rough adjustment of turns upon the primary.

It has been found that quite a considerable band of frequencies can be covered with fair efficiency by means of a primary winding of a fixed number of turns, and by means of a few tapings it is possible to cover the whole of the broadcast band with reasonable efficiency, since the tuning of the aerial circuit as such is extremely flat, consisting, as has been explained before, of a double-humped resonance curve with very flat peaks. (Fig. 3.)

**Selectivity**

In the secondary circuit tuning is sharp, the actual degree of selectivity obtained depending upon the high-frequency resistance of the secondary coil, the degree of coupling to the aerial circuit, and the size of the aerial coil for a given station. In general, the smaller the number of turns upon the aerial coil the greater will be the degree of selectivity, but of course signal strength will fall off if the turns are reduced too much.

It is interesting to consider the effect upon the signal strength of variations in the number of

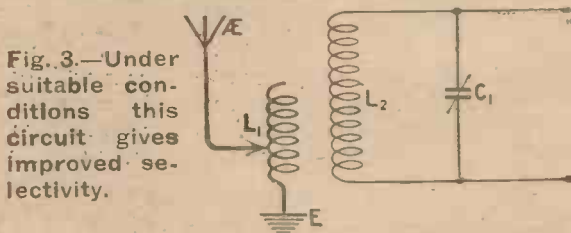

Fig. 3.—Under suitable conditions this circuit gives improved selectivity.

turns of primary and secondary windings, and this point should be given careful consideration in the design of a receiving set. Fig. 4 shows two typical curves, the one upon the left illustrating the effect upon signal strength of varying the number of turns in the secondary winding  $L_2$ . The result is very similar to that obtained when varying the number of turns upon the coil in a simple parallel-tuned aerial circuit, signal strength rising as the number of turns is increased. As a

matter of fact, however, the curve is usually somewhat steeper than that which results in the case of the parallel-tuned aerial circuit.

**Primary Turns**

Upon the right of Fig. 4 is a typical curve showing the effect upon signal strength of varying the number of turns in the primary winding for a given station. It will be seen that starting with a small primary of, say, 15 turns, signal strength rises to a maximum with about 20 turns, falls sharply into a dip at 25 turns, rises again to a maximum, and then slowly falls off once more, the whole forming a double-humped resonance curve of the familiar type. The position of the

arrangement is simply functioning as one of the familiar fully-tuned primary and secondary circuits, with an excessively close degree of coupling; so that the tuning of the secondary circuit is flattened right out.

**Advantages of a Tapped Primary**

It is evident that when one of these schemes is used it is desirable to adjust the number of turns upon the primary with a certain amount of care for any given station, and the practice of using a tapped coil is to be recommended. For a set which is designed to cover the whole band of frequencies probably three tappings are desirable; the actual number of turns at which each is made



The tuner used by  
Mr. G. P. Kendall  
when conducting his  
interesting experi-  
ments on aerial  
circuits.



dip which is shown occurring at 25 turns will, of course, depend upon the frequency of the station which is being received, falling higher up in turn numbers for stations of lower frequency (higher wavelengths).

**Effect on Selectivity**

A characteristic which should be noticed is that selectivity is very much affected by the point upon this double-humped curve at which we happen to be working, being good down either of the outer slopes of the curve, for example, at the points X and Y, corresponding to about 18 and 30 turns, but being very poor in the dip between the two humps, say, between 22 and 28 turns. In this region, the aerial circuit has come more or less fully into tune with the received signal, and the

depending, of course, upon the diameter of the coil. The safest course to adopt in receiving any given station is to work as far down upon an outer slope of the double-humped resonance curve as possible, without losing an undue amount of signal strength, since in this way the maximum of selectivity will be obtained.

**The Auto-Coupled Circuit**

The auto-coupled arrangement does not call for very much explanation, since in behaviour it is closely similar to the "tight" inductively coupled circuit, as will be realised upon a consideration of Fig. 5. Instead of using a separate aerial winding, the aerial is simply connected to a tapping point somewhere fairly near to the earth end of the secondary coil, and the whole arrangement then

## "Duco" Panel Switches

TYPE A.

Neat switches which require but one hole for fixing. Can be used as ON-and-OFF main switch for L.T. or H.T. supply, for switching Phones or Loud-Speaker, and for switching Low Frequency Valve.



No. RS41 18 S.P.D.T. ... each 2/3  
No. RS41 19 D.P.D.T. ... " 4/-

## "Duco" Stud Switch

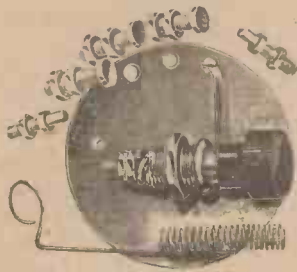

Constructed of best quality brass, handsomely finished. Contact studs fit almost flush on the panel, and the one-hole fixing bush enables a neat and simple fitting to be made. A length of wire is included for connecting to switch arm. For marking out correct position on panel for contact studs a brass template is provided. Ideal tapping switch for inductance coils, or as an "on-and-off" switch.

No. RS70 2 2-way, each 2/3    No. RS702 4-way, each 2/3  
"                    3-way            2/3                    6-way            " 2/3  
"                    No. RS70 1/2 10-way            " each 2/6

(Also stocked in Nickel finish, price extra.)

# Brown Brothers Limited

— Allied Companies —  
THOMSON AND BROWN BROTHERS LTD  
BROWN BROTHERS (IRELAND) LTD

— WHOLESALE ONLY —

GREAT EASTERN STREET, LONDON, E.C.2  
126, George St, EDINBURGH, and Branches

Please order from your Local Wireless Dealer.



## The New Duplex Terminal

WHILE it has not been found possible to improve the design of the T.C.C. Mansbridge Condenser, important alterations have been effected in the actual metal case. The new T.C.C. Mansbridge is fitted with Duplex terminals. A quick connection can now be made by means of the milled head. Soldering can still be carried out—a lug being fitted as shown.

One further improvement to be found is the use of a metal top instead of a pitch sealing compound. Thus the danger of heat affecting the Condenser during soldering is now completely abolished.

Once more T.C.C. demonstrates its ability to lead the way in condenser design—its 20 years' experience places it in a unique position for building genuine Mansbridge Condensers accurately and economically.

T.C.C. Mansbridge Condensers are now supplied in green metal cases in all values from .005 mfd. to 4 mfd. Ask for them.

## Get the new T.C.C. Mansbridge



# T.C.C. Mansbridge Condenser

Telegraph Condenser Co., Ltd., Mortlake Road, Kew,

Gilbert Ad. 4592



## You can always tell the "POWQUIP" House

It is never without bright Entertainment from Any Station. Without an Efficient Transformer the Would-be Listener-in abandons all efforts and seeks Enjoyment Elsewhere.

# - POWQUIP - TRANSFORMERS

Send a postcard for our booklets on wireless,—they are not catalogues but full of simplified data.

THE POWER EQUIPMENT CO., LTD.,  
Kingsbury Works, The Hyde, Hendon, N.W.9.  
Telephone: Colindale, 6196 & 7. Telegrams: Powquip, Hyde, London.

*A receiver is only as good  
as its components*

When making a final choice of components, remember that MH Products are guaranteed for 12 months.



THE quality of its component parts is the measure of the success of any radio receiver.

A set can be built for distance, volume or for clear tone, but for the best results from any circuit—build with **MH** Components—Quality Counts.

No matter what type of receiver you have or what type you intend to build—be safe in the assurance of maximum results always—incorporate **MH** Components.

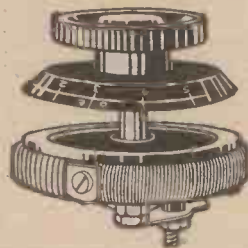

**MH** FILAMENT RHEOSTAT.

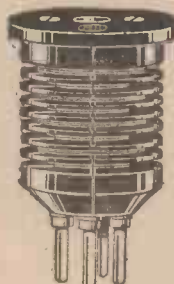

**MH** H.F. TRANSFORMER.

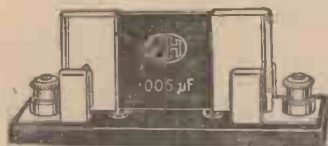

**MH** MICA FIXED CONDENSER.

**MH** FILAMENT RHEO-STATS.

These Filament Rheostats have been designed for either Dull Emitter or Bright Emitter valves.

Prices.	Each.
Bright Emitters ...	5/6
Dull Emitters ...	6/6
Double, Bright and Dull Emitters ...	7/6
Triple Rheostat ...	22/6

**MH** POTENTIOMETER  
Panel Mounting, 7/6 each

**MH** MICA FIXED CONDENSERS

Are of the permanent capacity engraved thereon and instantly interchangeable.

0.0001 $\mu$ F to 0.0009 $\mu$ F	2/6 each
0.001 $\mu$ F to 0.01 $\mu$ F	3/- each
0.015 $\mu$ F to 0.02 $\mu$ F	4/- each

(Two clips supplied with each condenser.)

Above mounted on ebonite base with terminals as illustrated, any value, 1/- extra.

**MH** COMPONENTS includes:

“Dimic” Coils, H.F. Transformers, Supersonic Units, Supersonic Outfits, Autodyne Units, Grid Leaks, Anode Resistances, Coil Holders, and Coil Mounts. Obtainable from all Dealers.

**MH** H.F. TRANSFORMERS

“The Transformer that made H.F. Amplification popular.”

Supplied in six ranges of wavelengths covering 30 to 7,000 metres.

Price 10/- each. With H.F. Damper, 12/- each.

Special Neutrodyne Units and Superheterodyne Couplers also supplied.

All Transformers are accurately matched.

Specify



**MH** H.F. DAMPER Price 2/-

The H.F. Damper is a device which, when inserted in the central hole of the H.F. Transformer, stabilises a circuit which otherwise could oscillate.

**L.M. MICHAEL LTD**

Manufacturers of Wireless and Scientific Apparatus

WEXHAM RD., SLOUGH, BUCKS.

Telephone: Slough 441-442.

Telegrams: Radiether, Slough.

behaves in a very similar manner to the one previously considered.

The auto-coupled circuit does not in general

provided that a suitably weak degree of coupling can be arranged between the primary and secondary, a fairly high degree of selectivity is obtainable.

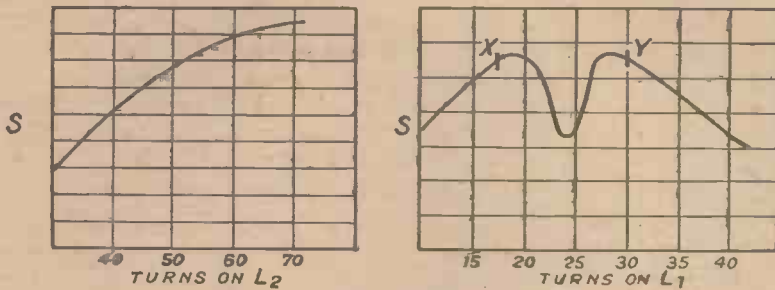

Fig. 4.—Showing the relation between signal strength and turns in the primary and secondary in the circuit of Fig. 3.

appear to give so high a degree of selectivity as is obtainable with a separate aerial winding, although the difference is not very great when the number of turns of the aerial coil has been suitably adjusted for the station being received.

**A Limitation**

One point calls for mention in connection with the auto-coupled circuit, and that is that the capacity of the aerial is to be regarded as connected in part across the secondary winding. The effect of the aerial capacity is not felt to the full, however, since it is only in fact connected across a part of the winding of the coil, and so has a reduced effect upon the frequency to which the secondary is tuned by a given added capacity.

As the number of turns in the aerial circuit is increased, however, so the effect of the aerial capacity upon the tuning range of the secondary is increased, and this fact is something of a limitation to the use of this method. In effect, it means that one is not able to use so large a secondary coil as is possible in the case of an entirely separate aerial winding.

**Coupling Methods**

To obtain really good results with one of these schemes some better method of adjusting the

Fig. 5.—The auto coupled circuit closely resembles that of Fig. 3 in its behaviour.

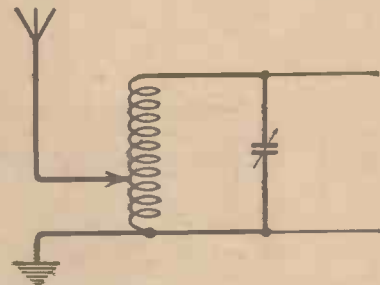

coupling is desirable than is provided by the ordinary two-coil holder, since with most varieties of this component it is not possible to get the two coils sufficiently far apart to secure a really weak coupling. For example, with certain coils I have noticed that in a particular type of coil-holder the coupling remains so strong that in a position with the two coils nearly at right angles to each other a double-humped resonance curve is still being obtained, indicating that much selectivity is being lost through lack of the necessary weak coupling.

**Three Coils**

Probably the best method of arranging this circuit is to use three inductances, two being connected in series in the aerial circuit, one of considerable size to give the desired tuning effect, and one consisting of only three or four turns placed beside the secondary coil to give the desired

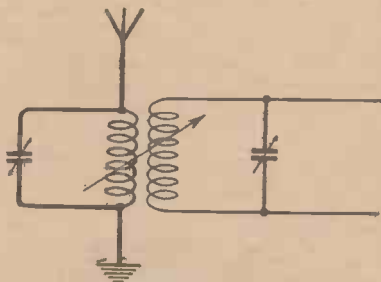
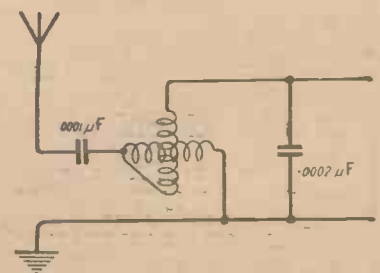

Fig. 6.—The main difficulty in this circuit lies in obtaining a sufficiently weak coupling.

**Loose Coupling**

The system of primary and secondary circuits commonly known as loose coupling has fallen into some disuse of late, yet the whole arrangement possesses considerable advantages in special cases. In this scheme, it will be remembered, we have an ordinary aerial circuit composed of, say, a plug-in coil with a variable condenser in series or parallel, and inductively coupled to this is a secondary winding composed of another coil and condenser, the degree of coupling between the two usually being adjustable. With such an arrangement,

Fig. 7.—A somewhat unconventional application of auto-coupling.



coupling. The first coil should, of course, be placed well away from the second two.

So far as signal strength is concerned the best

results are almost invariably obtained by keeping the primary tuning condenser in parallel, and using only a moderate size of primary tuning coil. The secondary coil should, of course, be reasonably large consistent with the desired tuning range.

**The Auto-Coupled Scheme**

An application of auto-coupling which deserves mention for the reason that it can readily be employed in a type of set which most people regard as quite incapable of conversion is illustrated in Fig. 7, and it will be seen that it applies to variometer-tuned receivers. One is rather apt to assume that a variometer can be used for one purpose and one purpose only, namely, to provide a simple tuned aerial circuit of only very moderate selectivity, but the device illustrated enables it to be converted into quite an effective auto-coupled scheme.

The idea is to convert the variometer into a secondary-circuit tuning apparatus, by connecting across it a fixed condenser of about .0002  $\mu$ F, and connecting the aerial through only part of the



A variometer can be effectively employed for auto-coupled circuits.

winding to earth to produce the desired auto-coupling. The method is to bring the aerial lead through a fixed condenser of .0001  $\mu$ F to the centre point of the variometer, and to connect the lower end of the variometer to earth.

*The standard wavemeter designed and used at the Radio Press Laboratories has an accuracy of one part in 3,000.*

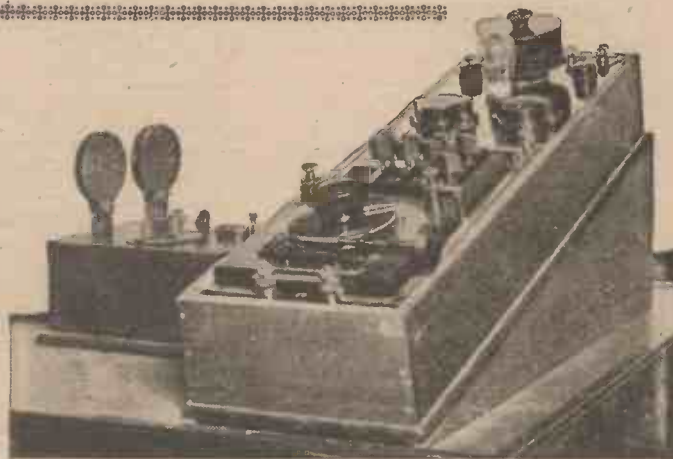

**A Variation**

Quite good results are obtainable in this way, and those who wish to obtain the best possible selectivity and signal strength may care to try a variable condenser instead of the fixed one of .0001  $\mu$ F, since in this way one can adjust the circuit very accurately to give the desired degree of the two factors in question. This hint may be useful to those who own crystal sets with variometer tuning who wish to obtain a somewhat higher degree of selectivity to minimise spark interference in bad localities.

**The Era of Low Loss**

(Concluded from page 721.)

the capacity between the valve sockets is a necessary feature, for this quantity will be in parallel with the external inter-electrode capacity of the inserted valve.

**The Aerial and Earth System**

It is frequently found that the aerial and earth system, though an essential portion of a wireless installation, is given the least attention by many experimenters. Low loss can be acquired here, however, if due consideration is paid to the avoidance of induced currents in any stay wires, lead roofing, gutters, etc., while the presence, close to the aerial, of impure dielectrics such as brickwork, trees, etc., will result in a loss of power. The "earth" itself should preferably be under the horizontal wires, and of such a nature that corrosion does not set in and eat away the material used or sever the earth lead at the point of connection. The earth lead should be kept short and should be insulated throughout its length.

**Aerial and Valve Couplings**

The reduction of damping effects in aerial and valve couplings has been dealt with at great length in the columns of this journal. The importance of tapping points must be realised in conjunction with loose coupling arrangements, while the resistance balance of all the parts of the given circuit must be aimed at in order to fulfil the elementary laws of maximum efficiency.



## Take the SHORTPATH to Better Reception

**K** EEN constructors are continually seeking fresh methods of obtaining better results from their sets. There is now available one simple method, one SHORTPATH to improved results.

The unique construction of the "Cosmos" SHORTPATH valves, whereby the path between filament, grid and anode is

reduced to an absolute minimum, enables results to be obtained unequalled by any other valve of the one cell accumulator class.

Compare their characteristics with published figures of other makers:—

	S.P. 18. RED SPOT.	S.P. 18. GREEN SPOT.
Voltage Amplification Factor ( $\mu$ )	7	15
Impedance	7,000	17,000
Mutual Conductance, (g) micromhos	1,000	850
Figure of Merit $\sqrt{\mu g}$	84	113

"Cosmos" S.P. 18 Valves provide a:—

SHORTPATH to: { MORE POWER  
FAITHFUL REPRODUCTION  
GREATER ECONOMY

S.P. 18 Valves consume 0.3 amps. at from 1.6 to 1.8 volts, and require only a single cell 2-volt accumulator. They are recommended for use as shown in adjoining table.

Obtainable from most Wireless Retailers.

**METRO-VICK SUPPLIES LTD.,**

(Proprietors: Metropolitan-Vickers Elec. Co., Ltd.),

**4, Central Buildings, Westminster,  
LONDON, S.W.1**

FOR BEST RESULTS S.P. 18 VALVES should be used as follows:—

Stage.	Transformer Coupling.	Resistance-Capacity Coupling.
H.F.*	Green •	—
Detector.	Green •	Green •
L.F. (1st Stage)	Green •	Green •
L.F. (Intermediate)	Red •	Green •
L.F. (Last Stage)	Red •	Red •

\* If set oscillates use Red • for H.F. Stages.

Price—Red Spot and Green Spot,  
12/6

The "Cosmos" D.E.11 Dull Emitter Valve takes 0.25 amp. at 1.1 Volts, and is a splendid Dry Cell Loud Speaker Valve.

12/6

The "Cosmos" A.45 Bright Valve is a highly efficient Valve for all reception purposes.

7/6

Have you got your copy of "A Talk to Valve Users"?

# Cosmos

## RADIO VALVES

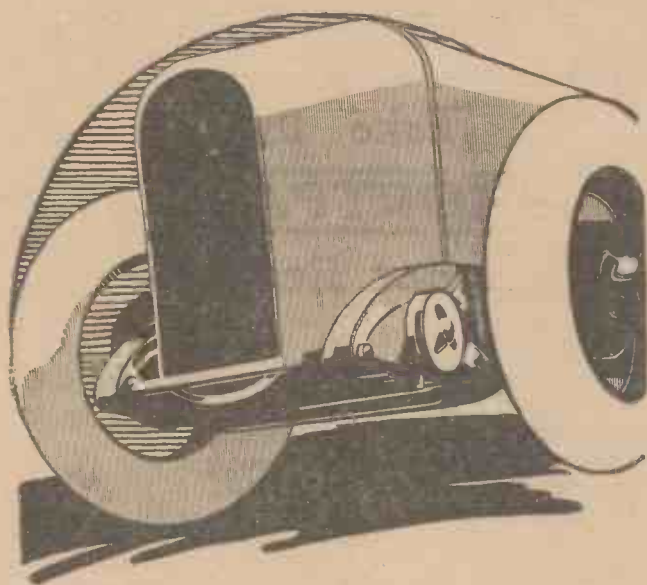

## SMOOTHING OUT SHOCKS



The purpose of the Mansbridge Condenser is to smooth out the shocks in your head-phone and loud speaker reception.

Every H.T. battery causes intermittent crackling noises owing to partial polarisation and other internal irregularities which cannot be controlled. A Mansbridge Condenser across the H.T. terminals of your set, however, at once eliminates these noises (which sound very like atmospherics).

Mansbridge Condensers are made in capacities from 0.2 to 2 microfarads, at prices from 2/6 to 5/-.

It is important to note that the only condensers made by the Mansbridge Condenser Co., Ltd., carry the words "Mansbridge Condenser" embossed on the case as illustrated above. There are many imitations, but only those bearing this characteristic are the genuine products of the Mansbridge Condenser Co., Ltd., and guaranteed and sold by the Dubilier Condenser Co. (1925) Ltd.

Note that the screw terminals are now also fitted with soldering tags.

MANUFACTURED BY THE  
**MANSBRIDGE**  
 CONDENSER CO. LTD.  
 GUARANTEED & SOLD BY THE  
**DUBILIER**  
 CONDENSER CO. (1925) LTD.

ADVERT. OF THE DUBILIER CONDENSER CO. (1925) LTD., DUCON WORKS, VICTORIA RD., NORTH ACTON, W.3 TELEPHONE: CHISWICK 2241-2-3 E.P.S. 6

## 'The proof of the CONDIT is in the circuit,' says CLIXIE



### "CLIXIE"

Fingers or  
 round-nosed  
 pliers to bend  
 CONDIT  
 please!

"Our postbag's full these days of enthusiastic letters about CONDIT," says CLIXIE. "Enthusiasm's a thing that many folk distrust, so I'm quoting a restrained one from Northumberland which I think is all the more convincing for its very restraint.

"Will you please send me another 2/- worth of H.F. Condit in a roll—it will save so much packing for so small a quantity. I have just wired up a single-valve set with this Condit and find it a distinct improvement on anything I have used."

"CONDIT is copper tape curled up into the form of split tubing (=16-gauge wire). There you have the reasons for that 'distinct improvement'—two highly polished conducting surfaces and the minimum of capacitive metal.

"Prove it on your circuit."

## RADIO CONDIT

(P. Patd.)

### THE H.F. CONDUCTOR

Per packet of six 2-foot lengths .. 2/-  
 Per coil of 12 feet .. .. .

Obtainable from all Wireless Dealers or direct from the Patentees:

AUTOVEYORS LTD., 84 VICTORIA ST., LONDON, S.W.1

## Single and Multi-valve Sets

secure a consistent and reliable supply of electrical energy when connected up to

## PETO & RADFORD

### ACCUMULATORS

The following types meet all requirements.

Type.	Voltage.	Actual capacity in ampere hours.	Price complete. Unit without crate. (Uncharged).
BD 5R	2	32	£0 14 0
BD 7R	2	48	0 19 0
BD 9R	2	64	1 3 6
BD 11R	2	80	1 6 9
BD 13R	2	96	1 10 0
			Price complete without crate (uncharged).
GFC 5	2	40	£1 6 3
GFC 7	2	60	1 11 3
GFC 9	2	80	1 17 6



For 4 and 6 volt units prices are pro rata and include the requisite number of separate 2-volt cells and the necessary cell-to-cell connectors. Carrying strap for each Type BD 2-volt unit, is. extra.

## PETO & RADFORD

Proprietors:

Pritchett & Gold and E.P.S. Co. Ltd,  
 50, Grosvenor Gardens,  
 Victoria, London, S.W.1.

Phone. Victoria 3667 (5 lines).



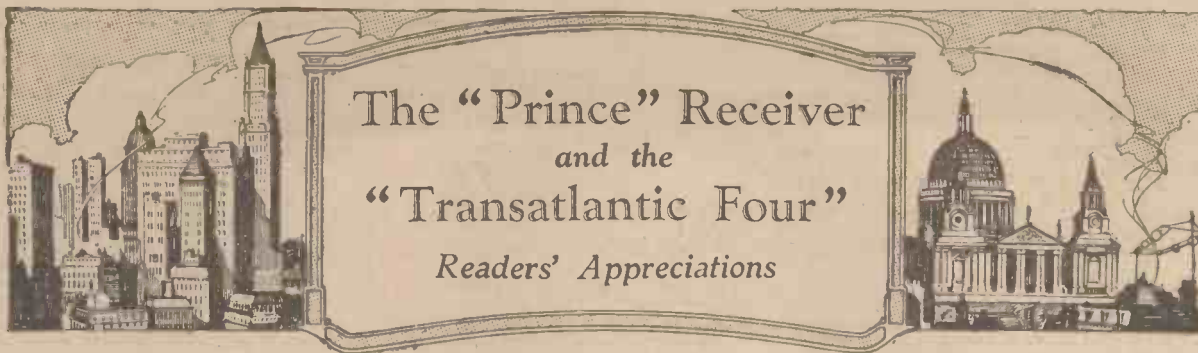

**The "Prince" Receiver**

Sir,—I have been very interested in the "Prince" receiver described by Mr. A. S. Clark in the January, 1926, issue of MODERN WIRELESS. One certainly gets wonderful purity on the loud-speaker, and a more faithful reproduction of the notes at the lower end of the scale, and of the drums.

As a matter of fact I only wired up the first two valves as I live less than 1½ miles from 2LO. With an indoor aerial the results are really too loud on the two valves. I am using D.E. 5b and D.E. 5 valves with the H.T. and grid-bias values recommended in the article. With an outdoor aerial I have to use 9 volts on the first grid before the set will work and the signals are almost deafening though quite pure. In order to get reasonable strength with the outdoor aerial, I have altered the tuning arrangements and am using an untuned No. 25 coil as primary coupled to a No. 75 at about 65°, and I find this the best arrangement in my case as I can now vary the signal strength as I wish.

It is very interesting to watch the behaviour of a milliammeter in the anode circuit of the second valve. When the set is out of tune or no signals are being received the current is about 8 mA. with 110 volts H.T. As the set is tuned the current decreases to a minimum, and then increases again if one goes past the correct point. With everything correctly adjusted I find that the current is about 3-3½ mA.—Yours truly,  
Maida Vale. H. A. NEWTON.

**The "Transatlantic Four"**

Sir,—I think it will be of interest to you to know something about my "Transatlantic Four" set, the design of which was published in MODERN WIRELESS in November, 1924.

I was in England in November, 1924, and although at that time perfectly innocent of anything connected in any way with radio, I chanced to pick up the number in which Mr. Percy W. Harris de-

scribed this set, and was at once impressed with the possibilities if I should be able to construct the set as described, as in this island the opportunities of hearing good concerts are extremely rare. I placed an order for all the parts referred to, and on arrival in Trinidad proceeded to construct the set. My difficulties were added to by a very indifferent and clumsy soldering iron, and the foolishness of the suppliers in omitting to enclose sufficient small bolts and nuts suitable for the construction.

However, I had these specially made after some trouble and was thankful that the important items such as transformers, rheostats, etc., were enclosed. I suppose the actual assembly of parts took me five or six hours, and when I had tested the circuit the only alteration required was the reversal of the wires to the tuning coil holder. Within ten minutes I was listening to KDKA at 2,000 miles distance. I suppose the amateur enthusiast could not expect to have better conditions for trying out a new set than we have here.

Atmospherics are pretty bad at times, the Caribbean Sea being noted for this form of disturbance. At 600 miles or so, Porto Rico and Cuba are easily picked up even when atmospherics are very bad, then we get a station at Miami Beach, which is a good standby for a programme when the more distant stations are not easily obtained. I think it will be interesting to you to know that I regularly get certain stations from two to three thousand miles away, and that the reception is pure in tone and a delight to myself and others who appreciate good music. Any night I can depend on getting and holding any of the American stations of average power.

It will interest you further to know that I had a wireless engineer here some weeks ago, and after handling the "Transatlantic Four" he took a diagram away because he was impressed, and he has since written to say that it is the best four-valve set he has yet seen.—Yours truly,

ARTHUR G. V. BERRY.  
Pointe à Pierre, Trinidad.

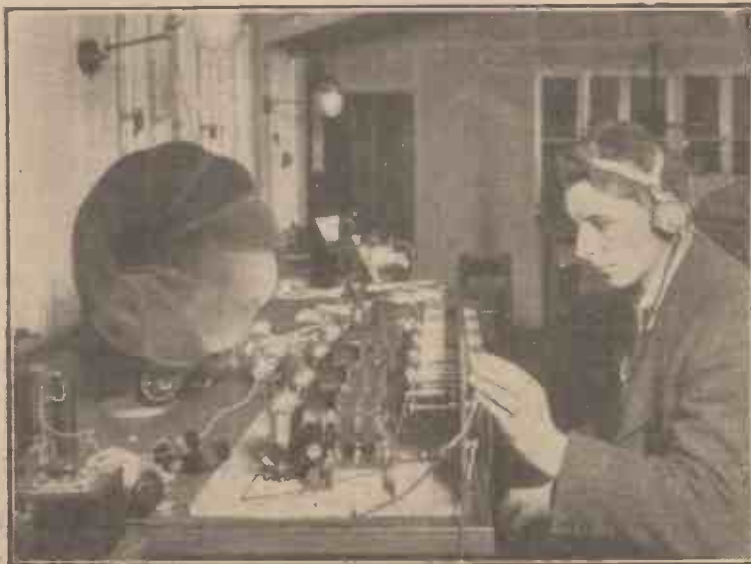

A member of the Radio Press Laboratory Staff using a sensitive receiver for receiving distant stations.

# Crystal Circuits in Theory and Practice

By the Staff of the Radio Press Laboratories

*The importance of efficiency in crystal sets cannot be over-emphasised. The information contained in this article should do much to elucidate many of the problems met with in practice.*



It is perhaps more important in a crystal set than in any other to obtain the utmost efficiency. The chief reason for this is that we are entirely dependent for our energy supply upon that picked up by the aerial. Further, few experimenters are situated so near to a broadcasting station that an increase in signal strength would not add to the comfort of reception. It was, therefore, decided to obtain some precise information as to the best type of crystal circuit to employ under certain conditions.

### Information Required

For this purpose it was necessary to decide exactly what is required in an efficient crystal circuit, and how to make the best use of the components available. In the first place, it is generally found that signal strength is more important than selectivity. It is true that for listeners living in coastal towns selectivity is important, but, at the same time, in the majority of cases, cutting out a station with a crystal set is not nearly so important as bringing one in with sufficient strength.

As regards frequency, it was thought best to concentrate first of all on the higher broadcasting frequencies and leave the question of the lower frequencies until a later date.

### Two Main Factors

An examination of various crystal circuits shows that there are two main factors to be considered: (1) the tuning arrangement employed, and (2) the device, if any, employed to adjust the load of the crystal on the aerial circuit.

For the purpose of examining the effect of these factors it was necessary to approach the subject simultaneously from a theoretical and from a practical point of view.

### Theoretical Considerations

It is not proposed to trouble readers with a mathematical analy-

sis of the crystal circuit. Although crystal sets are relatively simple in construction and operation, the mathematical analysis is somewhat involved.

It is sufficient to say that we may deduce certain facts capable of experimental verification. One of these is that for maximum signal strength the load of the detector on the aerial circuit should be equal to that of the aerial itself.

### Further Details

We can say further that, assuming the H.F. resistance of any part of the coil to be proportional to its inductance, then strongest signals

ing out the steady anode current of the oscillator by means of the L.T. battery potential as shown.

Changes in anode current can then be read off very accurately by the galvanometer. The small coil in the aerial circuit is then coupled to the oscillator, the crystal circuit tuned, and the drop in anode current noted. This is repeated with various added resistances in the aerial circuit. The reciprocal of the drop in anode current is then plotted against added resistance, and this gives a straight line, which when produced backwards gives the circuit resistance.

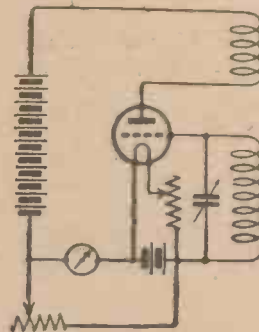

OSCILLATOR

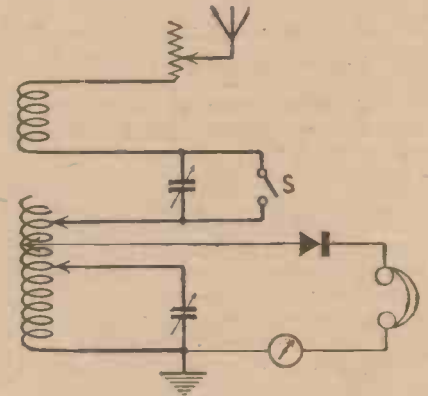

Fig. 1.—The circuit diagram of the apparatus employed in the experiments on crystal circuits.

will be obtained when tuning is performed without any additional added capacity. In other words, best results should be obtained theoretically when the tuning is performed by tapping the aerial across the correct portion of the coil required for tuning. Practically, it is somewhat inconvenient to tap any point of a coil. We may therefore infer that it might be better to tap across every two or three turns, and tune by means of a large series or small parallel condenser.

### Apparatus Employed

The apparatus employed is shown in Fig. 1, the oscillator being mainly for the purpose of measuring the H.F. resistance of the circuit. The method employed involves balanc-

### Measuring Selectivity

The oscillator is also useful for measuring selectivity. For this experiment selectivity was defined as the reciprocal of the change in frequency required to reduce the crystal current to one-half.

The measurement was carried out as follows: The crystal circuit was tuned to  $2LO$ , and the crystal current noted on a microammeter connected in series with the crystal. The circuit was then detuned to a higher frequency until the crystal current was reduced to one half. Both these frequencies were measured by the oscillator so that the difference could be readily obtained.

### Defining Selectivity

The above method of defining

# Praesis

ut

prosis

Latin motto: "Be first that ye may be of Service"



Brown Type H4

THE success of the Brown Loud Speaker runs parallel with the rapid growth of Broadcasting. Each year has seen the Brown more firmly established in public favour. Its long lead—for the Brown was the first Loud Speaker ever built in this country for wireless use—has never been seriously challenged.

True, the immense wave of popularity it has consistently enjoyed has often made a temporary shortage unavoidable. But S. G. Brown Ltd. have remained steadfast to an ideal—the continued production of a series of Loud Speakers worthy of the great reputation enjoyed by Brown Wireless instruments throughout the world.

Not for one moment would they permit a hair's breadth deviation from this most rigid standard of manufacture. Whether a man pays thirty shillings for a Brown H.4 or fifteen guineas for a Brown Q type, he obtains the same quality of materials, the same careful workmanship—and therefore the same dependable Service.

S. G. Brown Ltd., Western Avenue, N. Acton, W.3

*Retail Showrooms:*  
19 Mortimer Street, W.1  
15 Moorfields, Liverpool  
7 High Street, Southampton

*Depots (Wholesale Only):*  
13 Bushy Park, Bristol  
Cross House, Westgate Road,  
Newcastle

*Scottish Depot:*  
120 Wellington Street, Glasgow.

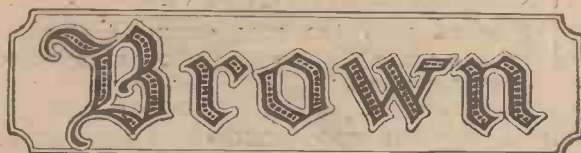

## Eight Types of Brown Loud Speakers

<b>Type H.1.</b> 21 ins. high. 120 ohms £5 5 0 2000 ohms £5 8 0 4000 ohms £5 10 0	<b>Type H.2.</b> Height 12 ins. 120 ohms £2 5 0 2000 ohms £2 8 0 4000 ohms £2 10 0	<b>Type H.3.</b> 15 ins. in height and in resistance of 2000 ohms £3 0 0	<b>Type H.4.</b> The smallest Brown Loud Speaker. Only 10 ins. high. 2000 ohms £1 10 0
<b>Type H.O.</b> 20 ins. high. Resistance: 2000 or 4000 ohms £6 0 0	<b>Type Q.</b> 23 ins. high. In resistances of 120, 2000 or 4000 ohms £15 15 0	<b>Cabinet Type</b> In Mahogany or Oak Cabinet, 2000 or 4000 ohms £6 6 0	<b>Crystavox</b> The only Loud Speaker which works from a Crystal Set. £6 0 0

## —three types of Headphones

<b>Type A.</b> As used by the Admiralty 120, 2000 or 4000 ohms £2 10 0 8000 ohms £3 0 0	<b>Type F.</b> Popular Broadcast type. Weight only 6 ozs. 2000 ohms £1 0 0	<b>Type A.2.</b> The New reed-type, unequalled for sensitiveness. 2000 ohms £1 10 0
--	---	--

## and two Gramophone Adaptors

For converting your Gramophone into a Loud Speaker	H.1 (2000 ohms) £4 10 0 H.2 (2000 ohms) £2 0 0
--	---

If the Trade have difficulty in obtaining Brown Wireless Instruments they should write to us without delay.



Above: Type HQ  
Below: Type H3

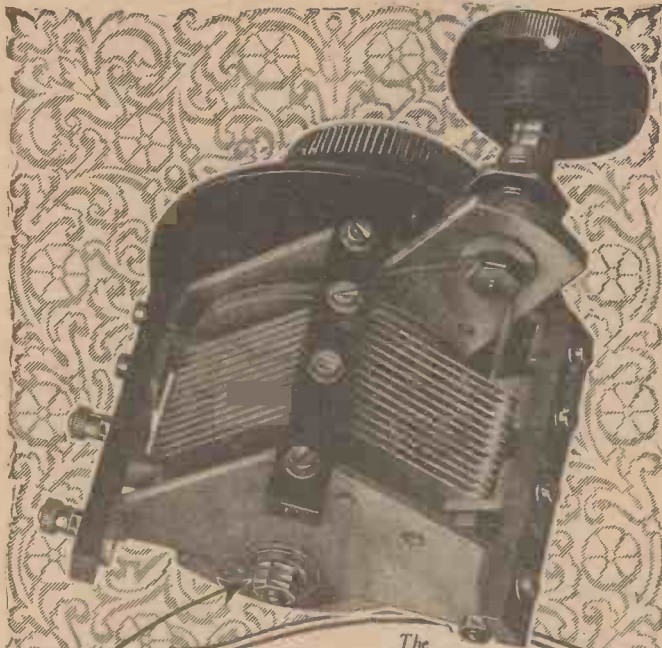

The  
**"COSMOS"**  
SLOW MOTION  
CONDENSER

COMPENSATED  
SQUARE LAW  
EFFECT

LOW LOSS

NO  
BACK LASH

with its ratio of 10 to 1 makes it possible to dispense entirely with the customary vernier and its attendant losses. Particular stations can be logged. Backlash is avoided not temporarily, but permanently and movement is smooth, permitting fine adjustment. This model can also be arranged for remote control, as shown in the illustration below. Also supplied without slow motion feature when the condenser is one-hole fixed. Both models are constructed to eliminate hand capacity, for low loss, and to give a compensated square law effect. Cone bearings of hardened steel ensure constant calibration and a pigtail connection gives permanent positive contact.

**Metro-Vick Supplies Ltd.**  
4, Central Buildings, S.W.1

Prices: <sup>R</sup>  
Ordinary. Slow Motion <sup>£99</sup>  
00025 mfd. 0005 mfd. 00025 mfd. 0005 mfd  
15/- 17/6 19/- 21/-

ADJUSTABLE  
CONE BEARINGS  
OF HARDENED  
STEEL

PIGTAIL CONNECTION



**COSMOS**

**AMATEUR CONSTRUCTORS**

We supply complete sets of components and cabinets for all Sets described in this issue.

**"MELODY THREE"**

by Mr. PERCY HARRIS.

	£	s.	d.
1 Panel Ebonite, 21 in. by 7 in. by 1 in. ...	0	9	6
1 Ebonite Terminal Strip, 7 in. by 2 in. ...	0	10	11
1 Variable Condenser, .0005, "Popular Type" ...	1	0	6
2 Variable Condensers, .0003, "Popular Type" ...	1	0	0
1 Marconiphone Variable Resistance ...	0	8	6
1 Polar Neutrodyne Condenser, Rack of Panel ...	0	5	6
1 Ellanpee Back of Panel Coil 1 lder ...	0	3	6
1 Connecticut Back Switch ...	0	1	6
3 C.A.V. Resistances ...	0	15	0
2 Igranic Pacent 2-circuit Telephone Jacks ...	0	5	0
3 Lotus Valve Holders, Anti-phonic ...	0	6	9
2 Standard Type Coil Sockets ...	0	3	0
1 Watmel Combined Grid Leak and Condenser ...	0	3	0
1 Ferranti L.F. Transformer, A.F. 3 ...	1	5	0
4 Belling & Lee Terminals, Aerial, Earth—L.S.—L.S.—	0	1	6
7 N/P Terminals, complete ...	0	1	2
4 Decko Dial Indicators... ..	0	0	8
Glazite Wire ... ..	0	1	2
1 Mahogany Cabinet, as described, with baseboard, CAMCO... ..	1	12	0
	<b>£7</b>	<b>19</b>	<b>2</b>

Send stamp for lists and let us quote you for Parts for the set you contemplate building. Carriage and Packing Free on Orders Value £2 and over

LARGE 145-PAGE ILLUSTRATED CATALOGUE OF COMPONENTS, ETC., PRICE 3d.

Book to Cross St.

Buses Nos. 4A, 30A, 19, 19C, 43A, 144A, 144B, 143F. Trams pass the Door, Nos. 33, 79T, 19, 13, 39, 35.

**NORMAN RADIO LTD.**

133a, UPPER STREET, ISLINGTON, N.1.

Telephone: Clerkenwell 3081.

**CAXTON 4-VALVE CABINET**

Made for Editor of Wireless Magazine for Set "As good as money can buy" described in issue February, 1925.

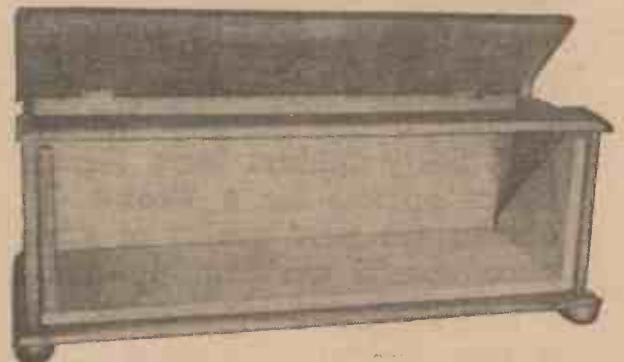

Cash with Order. Fumed Oak ... **£1 5 0**

or Real Mahogany polished ... **£1 14 0**

With detachable recess fitted Base Board to mount 21 in. by 7 in. panel to slide out of Cabinet front.

Extra 10/- with two beaded front doors totally enclosing fitted panel.

Cabinet overall length 22½ ins. Width 8½ ins. Height 9 ins.

Polished with the new enamel that gives a glass hard surface that cannot be soiled or scratched.

SENT FREE.—Catalogue of standard Wireless Cabinets in various sizes and woods. Special Cabinets made to customer's orders.

PACKED AND DELIVERED FREE IN U.K.

**CAXTON WOOD TURNERY CO., Market Harborough**

selectivity was employed in place of the more usual method of plotting resonance curves; for several reasons. In the first place it

known frequency, the resistance being determined in the manner previously described. The inductance was calculated from the

from which it will be seen that the inductance increases somewhat more rapidly than the number of turns, and the resistance increases somewhat more rapidly than the inductance. In other words the ratio R/L increases slowly with the inductance. The change, however, is not large, and is not likely to modify seriously conclusions based on the assumption that resistance is proportional to inductance. Further, since the inductance is roughly proportional to the number of turns, it was decided to plot the number of turns in the various curves obtained instead of inductance.

**Advantage of the Special Coil**

Another advantage of the coil employed is that it is particularly low loss, i.e., it has a total H.F. resistance of 5 ohms for an inductance of 228  $\mu$ H. This is probably due to the well-spaced turns, and to the gauge of wire employed being suitable.

It is recognised that all experimenters do not employ such an efficient coil as this, but the manner in which a less inefficient coil would modify results is shown in Fig. 5, which shows the effect of adding aerial resistance on the optimum tapping point for the crystal. Increasing the coil resistance would, of course, have the same effect, in the case given, as adding H.F. resistance in series.

**The Aerial and Earth**

The H.F. resistance of the aerial and earth system was next found. This was done by coupling the small

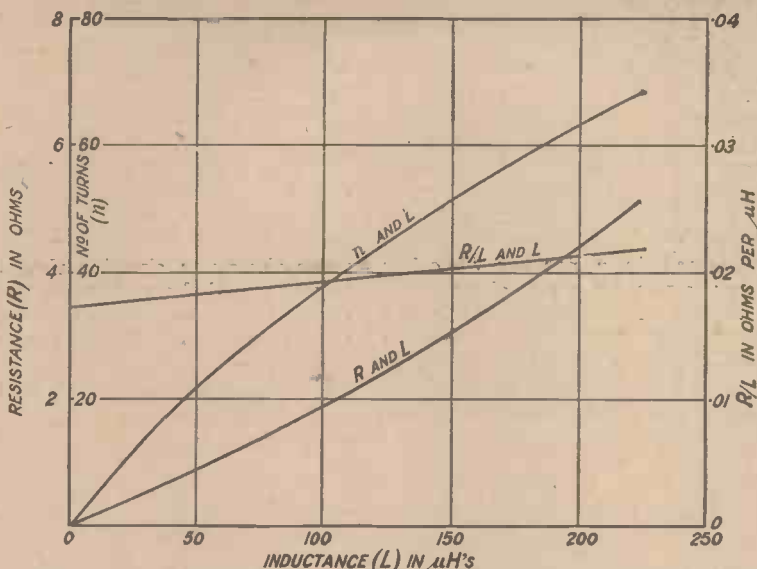

Fig. 2.—The inductance and H.F. resistance curves for a three-step low-loss coil.

gives a definite figure, which can be seen at a glance and remembered; secondly, it is easier to obtain, while further it is independent of amplitude and saves the trouble of reducing resonance curves to the same maximum. Finally, it enables selectivity to be plotted against other quantities, such as the number of turns across which the crystal is tapped.

**The Circuit Used**

Returning again to the circuit diagram of Fig. 1, it will be seen that a series condenser is employed in conjunction with a switch for shorting it when not in use. The coil employed was a three step coil as designed by Mr. G. P. Kendall, as this was found very convenient for tapping. This was wound with No. 22 S.W.G. enamelled wire, and provision was made for tapping the aerial, the parallel tuning condenser and the crystal across the required number of turns. It is, therefore, possible to test a number of different circuits without altering the lay-out of the apparatus.

**The Aerial Circuit**

Since it is necessary to know accurately certain characteristics of the aerial and coil, these were measured first.

By removing the aerial and crystal, and tapping the parallel condenser across the required number of turns, the resistance and inductance of various portions of the coil could easily be found. This was done by coupling up the oscillator which was tuned to a

known value of parallel capacity required to tune to the frequency of the oscillator, by means of the formula

$$f = \frac{10^6}{2\pi\sqrt{LC}}$$

where f is the frequency in cycles per second, C the tuning capacity in  $\mu$ F, L the inductance required in  $\mu$ H.

The results are shown in Fig. 2,

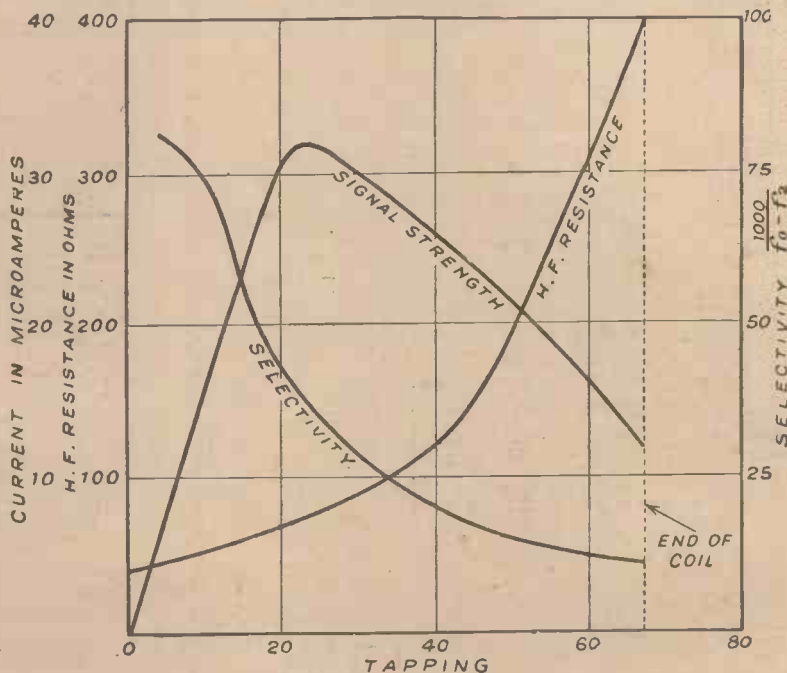

Fig. 3.—The effect of "tapping" on selectivity, signal strength and H.F. resistance.

coil to the oscillator as previously described. Actually, this gives the resistance of the whole aerial circuit, including the series condenser and coil. It is, however, justifiable in the case of even moderately good variable condensers to neglect their equivalent series resistance compared with that of an aerial system. It is clear, therefore, that by subtracting the resistances of the tuning coil and aerial coupling coil from that of the complete aerial system we obtain the resistance of the aerial and earth alone.

**The Aerial Employed**

The aerial employed was a single 80ft. length of 7/22 wire about 25ft. high. The earth was soldered to a water pipe which was some distance from the aerial. The conditions were, therefore, somewhat similar to those experienced by the amateur. There was, however, some advantage in that the aerial was in an open field, and except for some trees about 30 feet away, comparatively unshielded. Its H.F. resistance at 800 kilocycles, *i.e.*, at about 2LO's frequency, was found to be 31 ohms, which is probably a fair average value. Many aerial and earth systems undoubtedly have a much higher resistance than this, but on the other hand under favourable conditions it should be possible to reduce the resistance to a much lower value.

**The Effect of a Crystal Tap**

The first series of experiments made were conducted with a view to finding the effect of altering the crystal tapping point on signal strength, selectivity and apparent H.F. resistance of the aerial circuit. For this purpose the crystal contact was adjusted until moderately good signal strength was obtained, and the contact appeared to be steady. The crystal employed was an ordinary synthetic galena, so that it was anticipated that the contact might change during the readings. Fortunately, the contact was found to be exceptionally stable, and this enabled continuous curves to be obtained with little trouble.

Fig. 3 shows the results obtained, the diagram being practically self-explanatory. It will be seen that the current rose from zero when the crystal was tapped across no turns, to a maximum at 24 turns, falling to less than half this maximum at the end of the coil.

At the same time the selectivity dropped steadily, while the resistance rose at a very rapid rate.

**Selectivity**

In order to render the meaning of the figure given for selectivity somewhat clearer, it may be stated

that the change in frequency required to reduce the current to one half was 12 kilocycles for the best selectivity, and 81 kilocycles for the worst selectivity. At the optimum tapping, a difference of 26 kilocycles was required to reduce the current by one-half.

**H.F. Resistance**

As regards resistance, it will be seen that this quantity is doubled when the crystal is connected across the optimum tapping. This is especially interesting as it was confirmed in a number of other cases, *e.g.*, with a coil alone.

Another interesting point is the very large increase in resistance which occurs when the crystal is tapped across the whole coil.

be seen that the higher the frequency, the lower is the tapping point. This is to be expected, theoretically, but it is difficult to predict the change theoretically unless the change in aerial resistance with frequency is taken into account.

**Size of Coil**

It is often thought that the optimum tapping point depends on the size of coil employed, and varies with it. Experiment confirms theory in showing that this is not so, if the resistance of the coil is small compared with that of the aerial, and as long as the optimum tapping does not come too near to the end of the coil. The

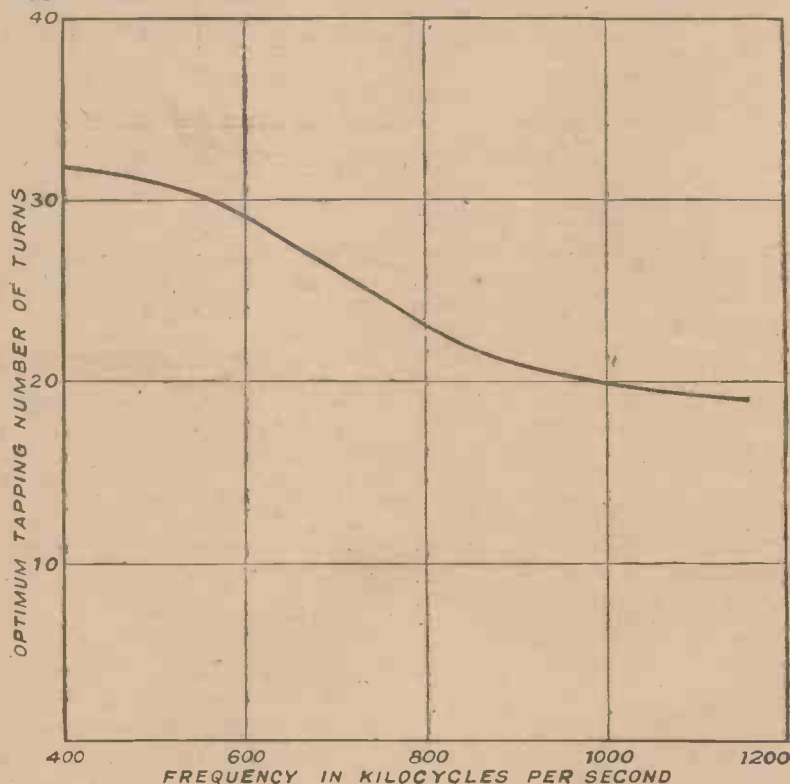

Fig. 4.—This graph shows the effect of frequency on the optimum tapping point.

**Effect of Input**

While on the subject of tapping points, it may be mentioned that an attempt was made to discover whether the optimum tapping point varied with input. This would rather be expected theoretically owing to the change in effective crystal resistance. It was found, however, that in practice the best tapping point did not vary appreciably between crystal currents of 10 microamps and 500 microamps.

**The Effect of Frequency**

Fig. 4 shows the effect of frequency on tapping point. It will

curves shown in Fig. 3 were obtained with all the coil in use, series tuning being employed, a tuning capacity of about .0002 μF being required.

On decreasing the size of the coil in the aerial circuit, and consequently increasing the series tuning capacity, it was found that the optimum tapping point did not change. On decreasing the size of the coil still further, however, parallel tuning was necessary, and the aerial tap approached the crystal tap. Under these conditions the crystal tap had to be decreased.

# 30 MILLION DUBILIER Condensers *Are now in use*

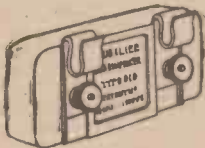

Type 610 Mica Condenser  
for general use in receive-  
ing circuits. Capacities  
0.0001-0.015 μF.

From 3/-



The Dubrescon  
Permanent Valve  
Protector - 6/-

These stupendous figures seem at first sight almost incredible. Yet they are correct, for Dubilier products are known and used all over the world.

The World's leading set manufacturers have standardised on Dubilier condenser equipment; the World's most important transmitting stations are equipped with banks of Dubilier Condensers, and every important Government department in the principal countries of the World makes use of Dubilier products for radio purposes.

The Dubilier Condenser Co. (1925) Ltd. manufacture Fixed Mica Condensers, Variable Air Condensers, Anode Resistances, Grid Leaks, the Dubrescon Valve Protector, the Ducon Aerial Adaptor, the Minicap Switch and the Mansbridge Variometer.

The Company are also sole concessionaires for the products of the Mansbridge Condenser Co. Ltd.

*Specify Dubilier*

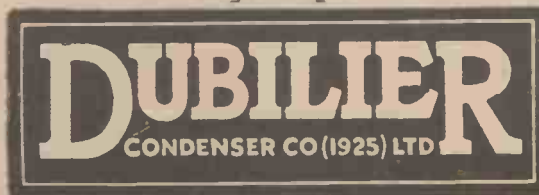

ADVERT. OF THE DUBILIER CONDENSER CO. (1925) LTD., DUCON WORKS, VICTORIA ROAD, NORTH ACTON, W.3.

TELEPHONE: CHISWICK 2241-2-3.  
E.P.S. 172

**Experimental Indications**

The experiments would indicate, therefore, that on the aerial employed a crystal tap is desirable when series tuning is employed, but is not so necessary when parallel tuning is used. In the extreme case when a very small coil is employed with a large value of the parallel tuning condenser, a crystal tap is unnecessary.

The reason for this is that provided the size of coil and tuning arrangements employed do not materially affect the total aerial circuit resistance, the inductance across which the crystal is tapped for strongest signals should remain approximately constant.

**The Effect of Aerial Resistance**

Fig. 5 shows the effect of adding aerial resistance on the rectified

the second case than the first if the pick up of the high resistance aerial is sufficiently great.

The fact that the optimum tapping rises with increase in aerial resistance is interesting. It means that the point of tapping approaches the end of the coil, and thus tapping is less important on high resistance aerials than on those with a low H.F. resistance. Actually, the tapping point never approached the end of the coil, even with an aerial resistance of 215 ohms. This was because the coil was very large, and if a smaller coil had been employed the optimum tapping point would probably have reached the end of the coil.

Before concluding, a few figures will be given to show the effect of altering the crystal contact on the optimum tapping point. In the table given below contact points

due to employing the wrong tapping point within the range of turns 22 to 28 is not very great. It certainly would not be audible, and hence it appears that there is very little reason for readjusting the tapping point for different crystal contacts.

**Future Experiments**

Although it is not suggested that the question of "optimum tapping" has been fully dealt with, yet it is hoped that the information in this article is sufficient to give the reader a clear idea of what to expect from a crystal set employing a tapped crystal. At a future date, the results of experiments on different tuning systems will be given from the points of view of both signal strength and selectivity.

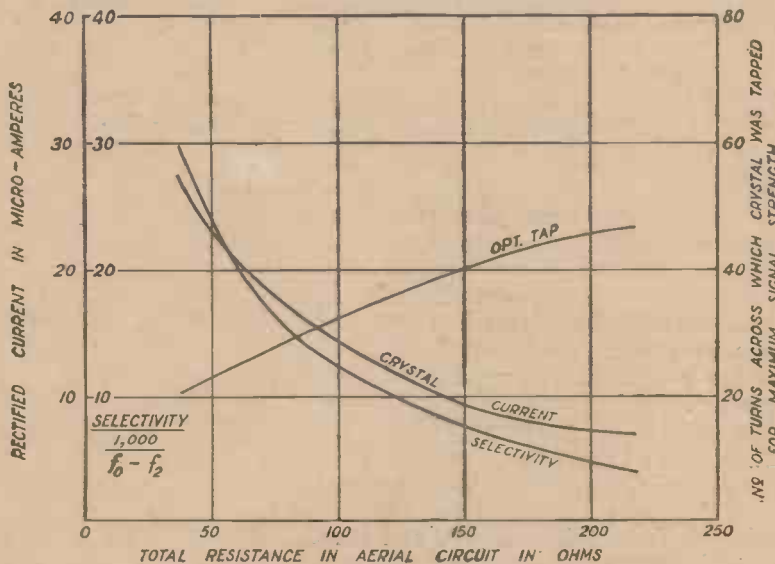

Fig. 5.—The effect of adding resistance to the aerial circuit is made clear by these curves.

current, the selectivity and the optimum tapping. All selectivity and current measurements were taken with the crystal across the optimum amount of inductance. It will be seen that while both the selectivity and crystal current fall with added resistance, the optimum tapping steadily rises. The actual figures, however, are not given.

**Results**

All these results are to be expected theoretically, and are useful to remember when designing a crystal set. Thus a set which is selective on one aerial will be less selective on another which has a higher resistance. Of course, the rectified current may be greater in

giving a very small current were neglected.

Contact.	Current in microamps.	Optimum tapping pt.
1	45	25
2	40	22
3	28	22
4	14	28
5	13	25

These are placed in order so as to indicate any possible connection between current and the tapping point. As far as the readings go there does not appear to be any connection. It is, however, interesting to note that the optimum tapping does not appear to change very much. If the signal strength curve in Fig. 3 is referred to, it will be seen that the fall in current

Another "Special Five" Enthusiast

SIR,—I feel I ought to write to you and tell you of the results I obtained with the "Special Five" receiver which Mr. Percy W. Harris described in the November, 1925, issue of MODERN WIRELESS. I built it almost as described, only altering the last stage of L.F., which I coupled with a transformer instead of resistance capacity. I am more than pleased with the set, and up to date I have logged the following stations on the loud-speaker: Brussels, Berne, Leeds, Bradford, London, Hull, Manchester, Dublin, Bournemouth, Hamburg, Newcastle, Toulouse and Birmingham.

On the higher wavelength I have so far got Daventry, Koenigs-wusterhausen and Hilversum, all these stations being at full loud-speaker strength. I may say I have had quite a dozen or more stations in addition, but not being very sharp at catching the call signs I have not identified them yet. The set is wonderfully pure, both in speech and music, etc., and in my humble opinion I should say it is as good, if not better, than any set on the market. My aerial is roughly 60 ft. long with a 30 ft. lead-in, inverted L type, being connected between two chimney-pots, and would be roughly 40-50 ft. high.

Thanking Mr. Harris for designing such a fine all-round set, and trusting this letter will interest you.—Yours truly,

J. V. P.

Harrogate.



# DO YOU WANT MORE VOLUME?

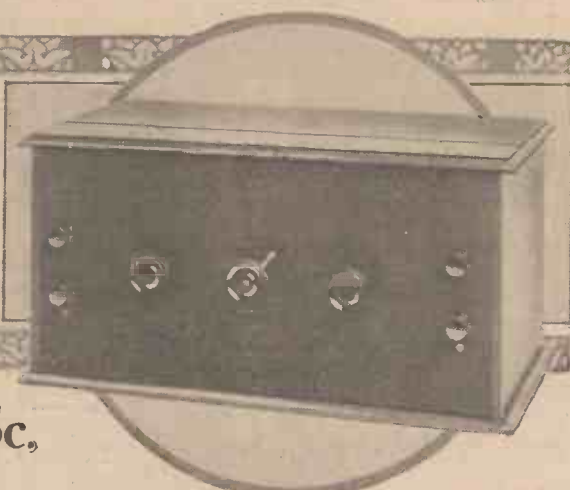

By G.P. KENDALL, B.Sc.

*When engaged on experimental work an amplifier similar to the one described here will be found invaluable.*

**T**HE instrument which is illustrated on these pages is one which I have recently constructed for the reason that in my experimental work such an appliance is found to be of considerable utility, and I believe that readers who do much experimenting will find it of use to them also. An amplifier which will convert the output from the detector anode circuit into signals of sufficient volume to work a loud-speaker is a most useful thing to have available in the course of experimental work, and the requirements for such an instrument are relatively simple.

### Requirements

In the first place, the instrument should be capable of giving either one or two stages of low-frequency amplification, and it is desirable that it should be of a fairly simple type, and also that it should give signals of really good quality in order that one may be able to judge of the quality given by any preceding circuit which may be undergoing tests.

### The Circuit

The circuit arrangement which I chose finally is illustrated in one of the diagrams, and it will be seen that it incorporates one stage of transformer-coupled low-frequency amplification and one of choke

coupling. The transformer is arranged to form the first stage, and the choke the second, since this is found convenient from the point of view of adaptability to any type of preceding circuit.

It is particularly convenient, in that there is little tendency for the amplifier to pick up and amplify high-frequency currents from the preceding circuit, provided that a

calls for a little explanation. It is to be understood that when the power to use either one or two stages of amplification is desired, it is best for the valve which is No. 2 when both are in use to be of a type capable of handling a fair amount of power, that is to say, to be suitable for the working of a loud-speaker.

Such a valve will be of fairly low impedance, say, from 5,000 to 10,000 ohms, and it is desirable that the loud-speaker shall always be connected in the anode circuit of this valve. The usual system of plug and jack switching is open to the objection that the loud-speaker or telephones are sometimes connected in the anode circuit of a suitable valve of the low impedance type, and sometimes in the anode circuit of one of the preceding valves, which may on the contrary be suit-

able only for resistance or choke-capacity coupling.

In the present set, for example, it would be convenient to use a D.E.5b. type of valve for the first stage, and a D.E.5 type for the second, and not very satisfactory results would be obtained if the loud-speaker or telephones were plugged into the anode circuit of the D.E.5b. when only one stage of amplification was desired.

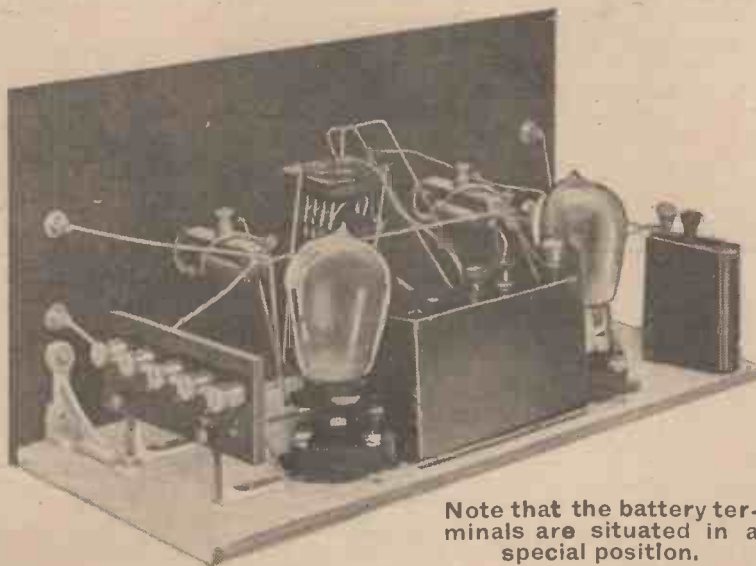

Note that the battery terminals are situated in a special position.

fixed condenser of quite moderate size is used across the output terminals of the receiver proper. If a transformer of fairly good make is used, and a choke of adequate impedance, such as the one which I have used in this set, really good quality is obtainable, with little difficulty as regards adjustment.

### Switching

The switching scheme adopted is slightly unusual, and perhaps

**Second Valve Always Used**

The system of switching adopted therefore operates by cutting out the first valve rather than the second, so that the second is always in use and the phones or loud-speaker are permanently connected in its

of the first valve, a second pair of contacts on the switch connects the grid of the second valve to the grid condenser and leak which couple it to the choke, whereupon the appropriate grid-bias tapping from the lower end of the grid leak

winding of the transformer to the grid of the first valve, and this will usually be of about 1½ or 3 volts in value. The other is connected in the alternative position of the switch, via the secondary winding of the transformer to the grid of the second valve, when this valve is being used alone. To carry out the switching described a "Utility" 4-pole change-over switch was used, only three of the poles being actually wired up. If a 3-pole change-over switch can be obtained, of course, so much the better.

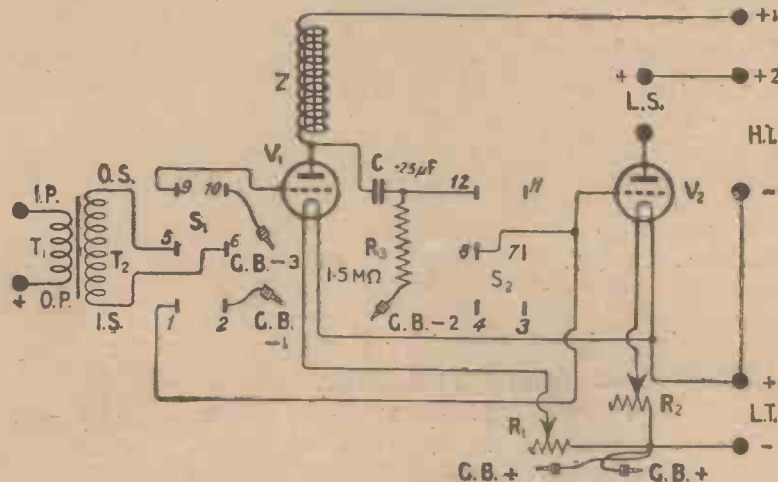

Fig. 1.—The switching system enables the second valve to be kept permanently in-circuit.

anode circuit. A careful examination of the circuit diagram will show how the switching scheme operates, and it will be seen that a three-pole change-over switch is needed. This switch operates by connecting the secondary winding of the L.F. transformer either to the grid and grid-bias connection of the first valve or to the second, automatic adjustment of grid bias being made when the change-over takes place.

When the transformer is switched to the grid and grid-bias battery

suitably adjusts the potential of the second grid.

**Grid Bias Connections**

It will be observed that three negative grid-bias leads are provided, one of them being from the lower end of the grid leak and two from points upon the switch, and these call for a word of explanation also. The one from the lower end of the grid leak of course is always connected, and supplies the second valve. One of those from the switch is connected via the secondary

**Components**

- One standard "All-Concert" cabinet with panel and shelf (Peto-Scott Co., Ltd).
- Two Angle brackets (Burne-Jones and Co., Ltd.).
- One Gecophone 2 to 1 ratio low-frequency transformer.
- One "Super-success" low-frequency choke (Beard and Fitch, Ltd.).
- Two Shock-absorbing valve-holders (Benjamin Electric, Ltd.).
- One Utility 4-pole change-over switch (Wilkins and Wright, Ltd.).
- One Mansbridge condenser .25 μF (T.C.C.).
- One 1½ megohm grid leak with clips (L. McMichael, Ltd.).
- Three black and two red H.T. battery plugs. (for G.B. plugs).
- Four ebonite-topped terminals (Sterling).
- One 5-terminal strip (this was one of the standard terminal strips of Messrs. Burne-Jones and Co., Ltd.), the two end terminals being cut off.
- Two interchangeable-bobbin filament rheostats (C.A.V.)
- Radio Press panel transfers.

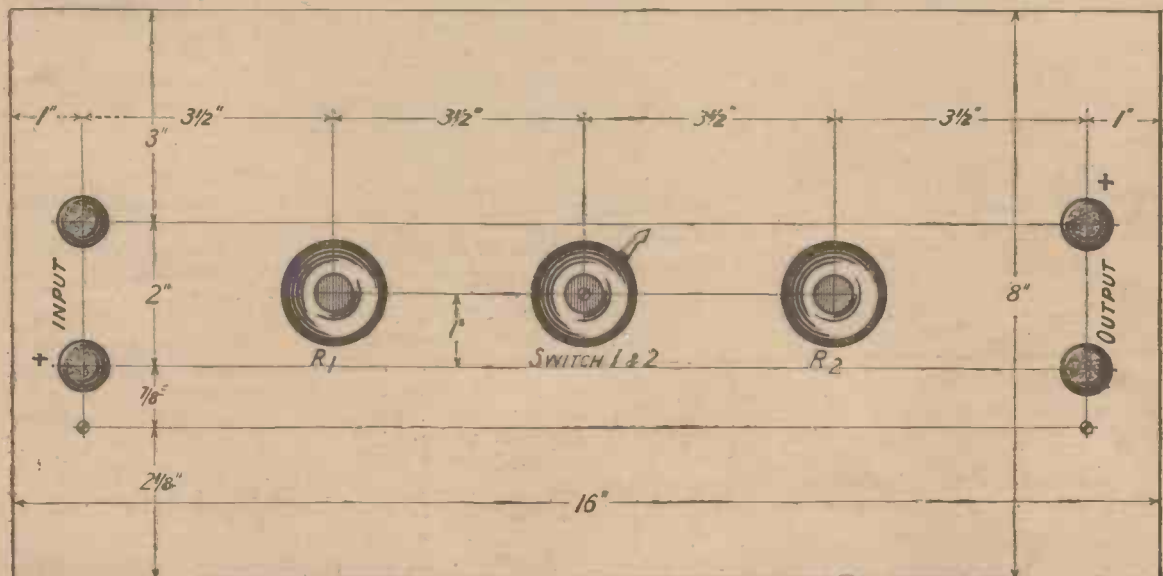
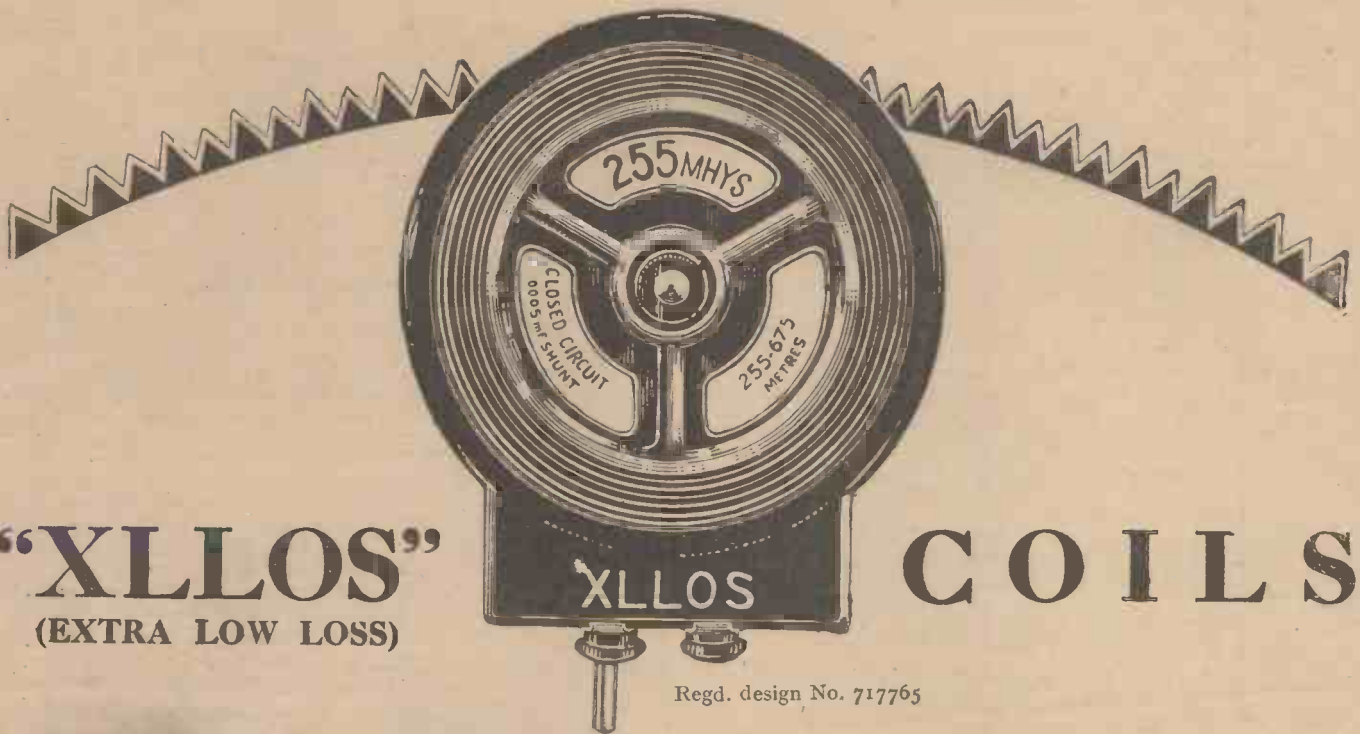

Fig. 2.—This diagram indicates that the panel layout is quite simple. Blue-print No. 150a can be obtained for 1s. 6d. post free.



**“XLLOS”**  
(EXTRA LOW LOSS)

**COILS**

Regd. design No. 717765

*Another IGRANIC Achievement*

**EXTRA LOW LOSS**—that is the keynote of the new Igranic “XLLOS” Coils. The special formation of the windings, the method of mounting and the absence of solid supporting material are all factors in making the coils highly efficient. Igranic “XLLOS” Coils possess high inductance and low self-capacity for a given size of coil, together with minimum H.F. resistance, and give sharper tuning with increased signal strength, and greater range of reception.

They are extremely adaptable as regards mounting, and may be used in standard coil holders, or the pin and socket may be spaced widely—with a consequent reduction in self-capacity and absorption losses—for use with special low-capacity coil-holders. Two contact pins are provided with each “XLLOS” Coil and these being removable, permit of two pin, two socket, or pin and socket mounting. The pins may also be inserted as shown in sketch 4 for pivotal mounting in conjunction with special clips which may be affixed to a vertical panel, thus providing a simple, efficient and inexpensive combination.

Sizes and Wavelength ranges:—

No. of Coil.	Inductance micro-henries.	Self-capacity micro-mfds.	Natural wavelength metres.	Wavelength in metres when shunted by .005 mfd. variable condenser.		Price.
				Aerial circuit using standard P.M.G. aerial.	Closed circuit.	
L. 25	29	12	36	220—280	85—225	5/-
L. 30	49	14	50	250—360	110—280	5/-
L. 40	90	16	72	350—490	155—400	5/2
L. 50	150	14	85	435—650	200—520	5/2
L. 75	254	13	109	550—835	255—675	5/6
L. 100	425	12	134	700—1000	325—865	7/-

One side of coil bears coil No. and approximate wavelength range in aerial circuit with .005 mfd condenser. On other side is stated inductance in micro-henries and wavelength range in closed circuit with .005 mfd. condenser. Write for the Igranic leaflet Z.982, which describes the Igranic “XLLOS” Coil in detail, or see the coil at your dealers.



Works: **LIMITED** **BEDFORD**

Exclusive Manufacturing Licensees of Patent Radió Essentials.  
**149, QUEEN VICTORIA ST., LONDON**

**THE IGRANIC INSTRUCTIONAL CARTON.**

For constructing a six-valve Supersonic Heterodyne Receiver according to the Igranic design, contains a comprehensive fully illustrated descriptive handbook full-size general arrangement drawings, wiring diagrams and drilling template. Obtain a copy from your dealer.

**PRICE 2/6.**

**ADAPTABLE TO ALL METHODS OF MOUNTING**

1. Contact pin and socket spaced for standard type coil holders.

2. Wide spacing of pin and socket for special low capacity coil holders

3. Double pin mounting; the pins may be spaced as desired.

4. Low capacity pivot mounting to provide angular adjustment of coupling.

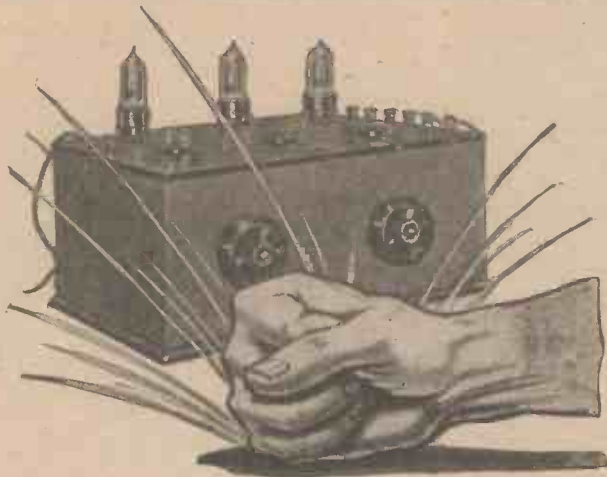

# Bang! and not a complaint from Neutron Valves!

No need for "anti-microphonic" valve-holders now. Vibration doesn't produce a sound from Neutron Valves with their long-lasting, robust filaments. With ordinary care, the Neutron Dull-Emitter will last indefinitely, giving full volume and distortionless reproduction; it is more robust than other D.E. Valves, being made to work safely on 3.5 to 4 volts. And what extraordinary volume is given by Neutron Valves will be demonstrated by your Dealer, if you ask him. Clear, bell-like reproduction, too. Change over to Neutron Valves to-day.

## NEUTRON VALVE

**H.F.—Red Spot    L.F.—Green Spot**

CHARACTERISTICS:		CHARACTERISTICS:	
Filament Voltage:	3.5 to 4 Volts.	Filament Voltage:	3.5 to 4 Volts.
Filament Current:	.06 Amperes.	Filament Current:	.06 Amperes.
Anode Voltage:	20-100 Volts.	Anode Voltage:	20-100 Volts.
Total Emission:	9 Milli-amperes.	Total Emission:	15 Milli-amperes.
Impedance (Approx.):	22,000 Ohms.	Impedance (Approx.):	12,000 Ohms.
Amplification Factor:	9.	Grid Bias Voltage:	Up to 6 Volts.
		Amplification Factor:	6 to 7.

Sold by Radio dealers everywhere. In case of difficulty send P.O. 12/6 for sample valve, post free. Address "Valve Dept. A." Neutron Distributors, Sentinel House, London, W.C.1. British made and guaranteed by Neutron, Ltd.

# .06 for 12/6



It will only cost you 6d.

to obtain particulars for building this wonderful Radion 5-Valve Neurodyne Set. The new Radion Book gives full constructional details of this and three other unique and efficient sets, a 1-Valve Set, a 2-Valve

Amplifier and a handsome self-contained Loud Speaker Receiver. Fully illustrated with photographs and diagrams, it should be in the hands of every wireless enthusiast. From your Dealer, or 6d. post free from

American Hard Rubber Company (Britain) Ltd.  
 Head Office: 13a Fore Street, London, E.C. 2  
 Depots: 120 Wellington Street, Glasgow, 116 Snow Hill, Birmingham.  
 Irish Agents: 8 Corporation St., Belfast.

# RADION

the Panel with a Pedigree

Gilbert Ad. 4584

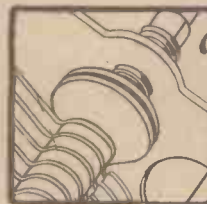

The Grounded Rotor that means fine movement—always

From an experimenter of 14 years' experience: "I find that with the special knob and dial supplied by you, make Geared Dials and Verniers unnecessary in my opinion, and I have been experimenting since 1912."

The first thing you notice about a "Cyldon" is its extraordinary smooth silkiness of action—a smoothness that spells successful tuning. Indeed so gradual is this movement that an additional vernier is unnecessary. The secret lies in the Grounded Rotor, one of the unique features that make the "Cyldon" the best condenser in the world.

# CYLDON

(pronounced Sil-don)  
 Straight Line Wavelength.

Complete with 4 in. knob dial—

.0005 mfd.	17/6
.0003 "	16/6
.00025 "	16/-
.0002 "	15/6

From all good Dealers or supplied POST FREE.

SYDNEY S. BIRD,  
 "Cyldon Works,"  
 Sarnesfield Road,  
 En, old Town,  
 Middlesex.

Tel.: Enfield 672.



Two small brass brackets to support the above strip. Square tinned wire or Glazite for wiring up.

**Construction**

The construction of the amplifier is quite simple, and probably the only points calling for mention are those concerning which of the parts should be fixed in position first. After laying out the panel and drilling the necessary holes the various components which are attached to it should be fixed in position before the panel and shelf are fastened together by means of the brackets.

Upon the shelf the grid condenser and leak should be mounted before the shelf and panel are fastened together, the other components being easily mounted afterwards. In wiring up, the connections to the switch should first be made, together with those to the

grid condenser and leak. Following these, the remainder of the wiring can be done in almost any order,

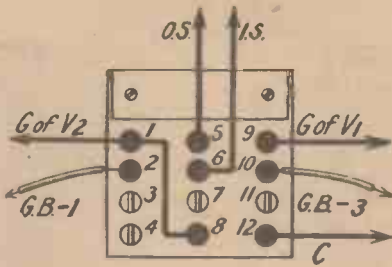

Fig. 3.—The connections to the switch are given here.

since few of the wires interfere with free access to the others.

**Valves**

To obtain the best results in an amplifier incorporating a stage of

choke-capacity coupling, it is important that a suitable valve be used in the first circuit. The correct type to employ when signals of moderate strength are being handled is the high-impedance high-amplification ratio type of which the D.E.5b. is a well-known example.

For the second stage a fairly low impedance valve is desirable, one of the type taking a filament current of a quarter of an ampere and with an impedance of perhaps 8,000 ohms being quite suitable. There is, of course, a wide range of small power valves of somewhat similar characteristics, and the constructor will naturally please himself as to which he uses.

**H.T. and Grid-Bias Voltages**

It will be noticed that two high-tension positive terminals are provided, supplying the two different

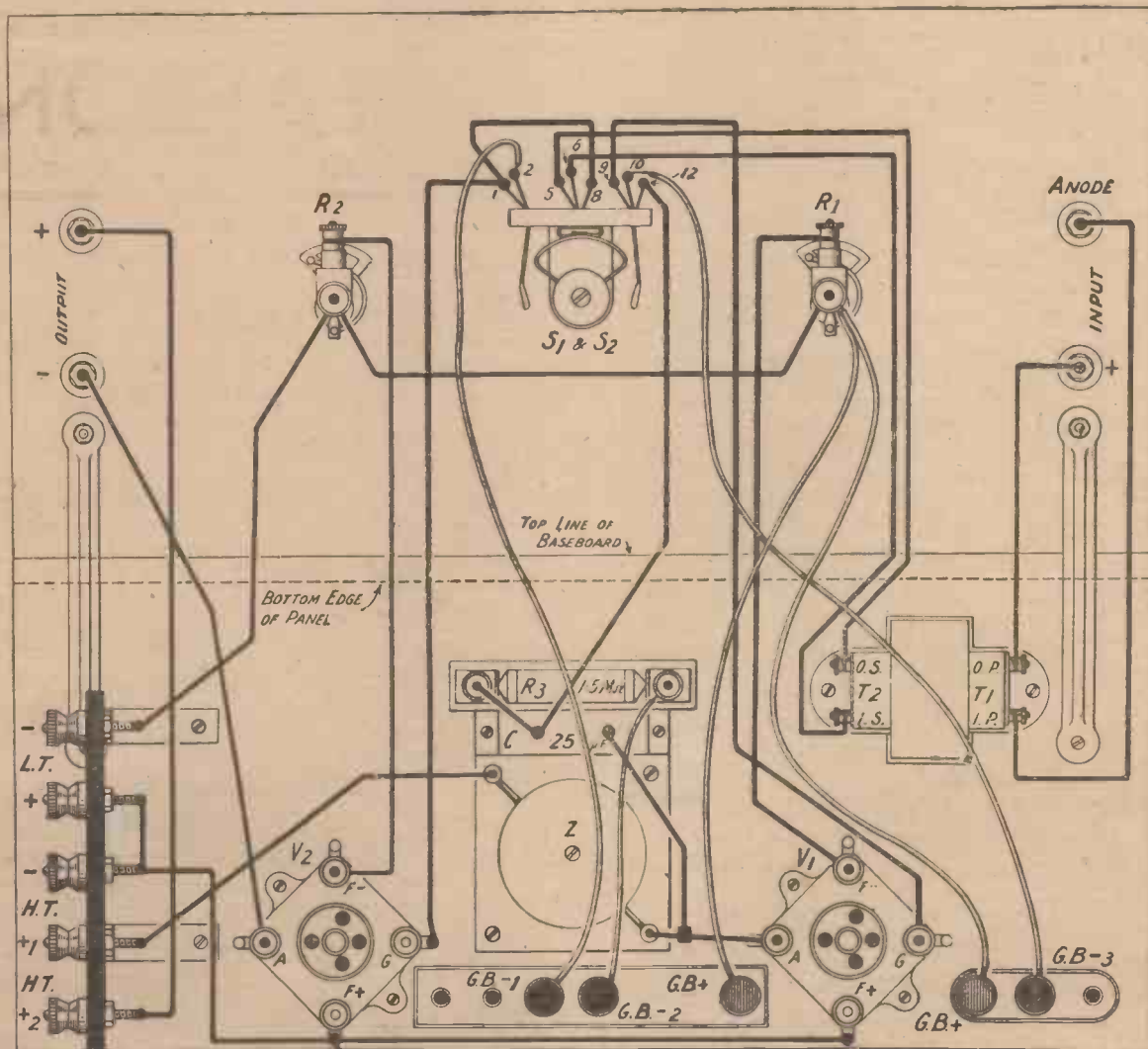

Fig. 4.—By following this diagram the amplifier may be wired without any trouble. Blue-print No. 150b is available for 1s. 6d., post free, for those readers desiring same.

valves, but it will not as a rule be necessary to apply a different voltage to these two points. About 100 or 120 volts will serve for the combination of valves mentioned, provided that a proper adjustment of grid bias is made.

Three flexible leads for the grid-bias negative connections are provided in the amplifier, and two positives. This was done in order that two separate grid-bias batteries might be used, one of small size for the first valve, and one of greater voltage for the second. The batteries actually used are a Siemens  $4\frac{1}{2}$  volt unit with tapping sockets at  $1\frac{1}{2}$  and 3 volts for the first valve, and a 9 volt unit with tappings at  $4\frac{1}{2}$ , 6 and  $7\frac{1}{2}$  volts for the second. For the first valve either  $1\frac{1}{2}$  or 3 volts will usually be correct, and this is applied to the plug marked G.B.—3.

For the second valve two separate grid-bias negative plugs are provided, these being G.B.—2 and G.B.—1. G.B.—2 is the lead from the lower end of the grid leak, and will usually require the application of about  $4\frac{1}{2}$  volts negative potential. The other lead comes from one of the points upon the switch, and serves to apply grid-bias to the valve through the secondary winding of the transformer when the

latter is switched on to the second valve in order to cut out the first stage. Under these conditions a slightly higher grid bias voltage

will usually be permissible, about 6 volts being suitable for the D.E 5 types of valve with 100 or 120 volts anode supply.

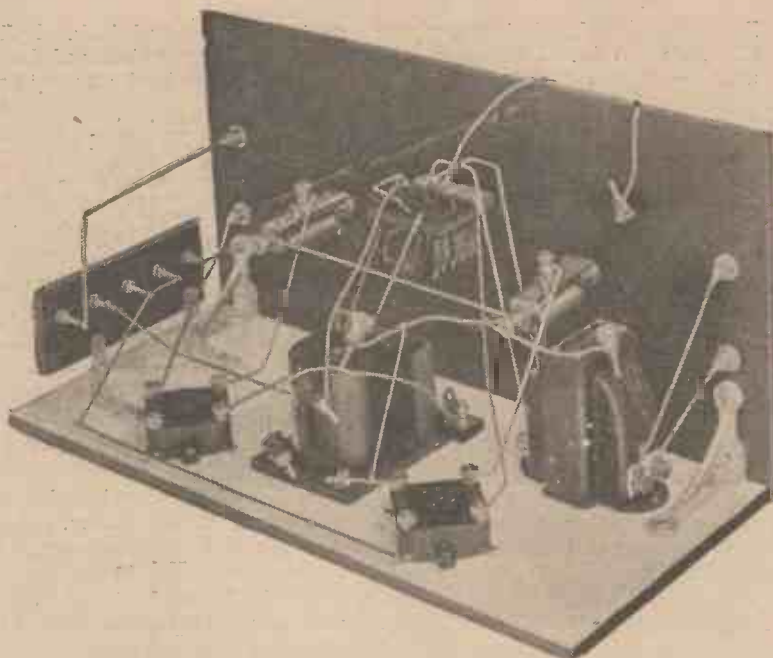

As shown in this photograph, wiring the amplifier should present no difficulty.

# The Microstat

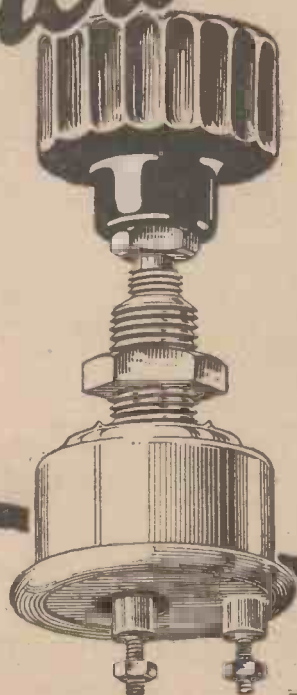

Price :

**2/9**

Insist on seeing the Patent No. 21823 on each Microstat.

## Saves Panel Space

Smaller, neater and sturdier than the crude and necessarily large wire rheostats, the Microstat greatly assists your panel layout—a great advantage in close wired circuits and portable sets.

The current is gradually applied with a smooth and silent action, and you will find selectivity vastly improved, and don't forget that it makes an excellent Master-rheostat in place of the pull-push or tumbler type switch.

For this purpose it saves its cost in a few months in increased filament life.

No soldering, and, naturally, one hole fixing.

"Packing" is entirely eliminated by an ingenious spring device.

Your dealer stocks Microstats—if any difficulty write direct.

# WATES

BROS. LIMITED,

Head Office: 13-14, Gt. Queen Street, Kingsway, W.C.2.

Phone: Gerrard 575/576. Grams: "Zywateseng, Westcent."

Works: LONDON and BIRMINGHAM.

March, 1926

MODERN WIRELESS

# Test ANY Loud Speaker

of other make  
against this



## 38/- "Junior"

### SWAN-NECK AMPLION

The "Junior" Swan-Neck AMPLION (A.R. 38) may not, of course, come out best against them all, but it will hold its own EASILY and CONCLUSIVELY against "twice the size" and "double the price."

Because of this exceptionally meritorious performance the "Junior" Swan-Neck has quickly become so great a favourite that it has been necessary to provide for an enormously increased output. All who desire "BETTER RADIO REPRODUCTION," with a reasonably moderate outlay, will be glad to know that quantity supplies are now forthcoming and that, therefore, they can secure just what they want—by ordering now an

THE  
WORLD'S  
STANDARD

# AMPLION

WIRELESS  
LOUD  
SPEAKER

OBTAINABLE FROM AMPLION STOCKISTS, RADIO DEALERS OR STORES.

Demonstrations gladly given during business hours at the AMPLION Showrooms: 25-26, Savile Row, London, W.1; 79-82, High Street, Clapham, S.W.4; 10, Whitworth Street West, Manchester; 101, St. Vincent Street, Glasgow.

*Ask your Dealer to let you hear it*

# Utility

GUARANTEED  
COMPONENTS

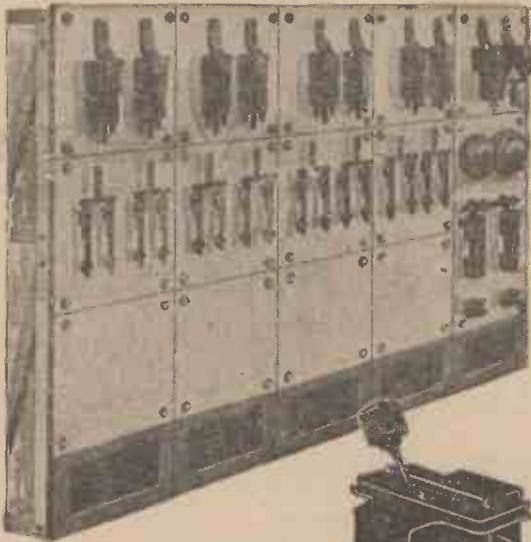

## Switches

The familiar Utility switches which figure in most British wireless sets have one great point in common with the Power Station switches controlling the lighting and tramways of our cities—they are designed by electrical engineers specially for the work they have to do.

Utility switches can be supplied with either knob or lever control and with 1, 2, 3, 4, 5, or 6 poles, at prices between 3/6 and 10/6, according to size, type and finish.

The contacts are of the rubbing type and are therefore self-cleaning.

Electrostatic capacity, one of the greatest sources of loss of signal strength, has been reduced to the absolute minimum, while the switches are extremely compact.

The knob control type have one hole fixing, and the lever type have been introduced for those who prefer this method of control.

**Furthermore they are all completely guaranteed and will be replaced if they fail to give entire satisfact on.**

Obtainable of all good dealers.

**WILKINS & WRIGHT, Ltd.**  
Utility Works, Kenyon Street, Birmingham  
E.P.S. 32

## THE H.T.C. COMPONENTS of superior efficiency, give better results!

for instance

### THE H.T.C. LOW CAPACITY VALVE HOLDER.



TYPE B

The ordinary type of valve holder wherein the sockets are embedded in a moulded insulating material is certainly not conducive to best results, especially in a radio frequency receiver. Recent experiment has shown the difference in capacity between the ordinary type and a valve holder with the sockets fixed on ebonite and separated by air to be as much as 14 times as great. Further, the capacity between the grid and anode sockets of the former valve holder is six times greater than in the latter type.

The H.T.C. Valve Holder effects a reduction in capacity to a much greater degree, which obviously introduces a higher efficiency into a receiver.

Logically the H.T.C. Valve Holder should be adopted in your set if you seek best results.

Then the **H.T.C. FIXED DETECTOR**  
A really permanent crystal detector, giving extraordinary loud signals for months. Especially suitable for S.T. 100 and all reflex-circuits using crystals rectification tested and actual broadcast.

H.T.C. Fixed Detector	...	...	3/6
Detector with Clips	...	...	3/9
Complete with Ebonite Base, Clips and Terminals	...	...	4/6

Your Dealer Stocks Them!

**H.T.C. Electrical Co., Ltd.,**  
Telephone: Battersea 374,  
2-2a, Boundaries Rd., Balham, London, S.W.1

The H.T.C.  
**EMPIRE**  
L.F. TRANSFORMER  
BRITISH  
& BEST.  
Guaranteed Ratio 4:1  
Price 7/6.  
Post 3d.

## GREAT SUCCESS OF THE LOWFORMA

This set embodying a **LOWFORMA** erected by the Technical Staff of the **WIRELESS MAGAZINE**, and fully described in the February issue (1926), has received the K.D.K.A. (East Pittsburg), 62 metres transmission, at loud-speaker strength, on a 21 ft. indoor aerial in London.

.. The ..  
**LOWFORMA**  
is a valuable unit which can be utilised in the erection of numerous Crystal and Valve Sets frequently securing  
**50 per cent. BETTER RESULTS.**

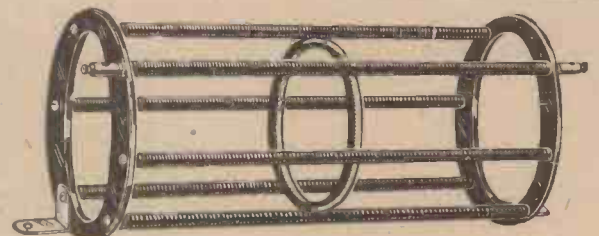

PRICES—4 in. diameter by 5 in. long, 4/9; 6 in., 5/-; 7 in., 5/6.  
OF ALL DEALERS, in case of difficulty write the makers—  
A. H. CLACKSON, Ltd. (Dept. K.), Heat Offices: 119, Fleet St., London, E.C.4.





Edited by CAPTAIN L. F. PLUGGE,  
B.Sc., F.R.Ae.S., F.R.Met.S.

Corrected up to February 20th, 1926.

Ref. No.	G. M. T.	Name of Station.	Call Sign and Wavelength.	Sit u ation.	Nature of Transmission.	Closing Time or Approx. Duration.	Approx. Power used.
<b>WEEK DAYS.</b>							
1	8.2 a.m.	Eiffel Tower ..	FL 2650 m.	Paris ..	Time Signal in G.M.T. (Spark) ..	3 mins.	60 Kw.
2	8.40	Eiffel Tower ..	FL 2650 m.	Paris ..	Weather Forecast ..	5 mins.	5 Kw.
3	9.23	Eiffel Tower ..	FL 2650 m.	Paris ..	Sidereal Time (Spark) ..	5 mins.	60 Kw.
4	11.0	Eiffel Tower ..	FL 2650 m.	Paris ..	Stock Exchange Quotations, followed by Time Signal and Weather Forecast	20 mins.	5 Kw.
5	11.20	Eiffel Tower ..	FL 2650 m.	Paris ..	Time. Fish-Market Quotations Cotton Exchange.	10 mins.	5 Kw.
6	11.40	Hilversum ..	NSF 1050 m.	Holland ..	News Bulletin ..	10 mins.	10 Kw.
7	11.57	Nauen ..	POZ 3000 m.	Berlin ..	Mid-day Time Signal in G.M.T. ...	8 mins.	50 Kw.
	This	Signal is relayed	by all German, Swiss and Swedish stations, except Stuttgart, Lausanne and Geneva (Spark).				
8	12.30 p.m.	Radio-Paris ..	CFR 1750 m.	Clichy ..	Concert, followed by News	2 p.m.	4 Kw.
9	3.0	Zurich ..	— 515 m.	Switzerland	Concert from Hotel Baur-au-Lac (relayed)	5 p.m.	500 Watts.
10	3.40	Eiffel Tower ..	FL 2650 m.	Paris ..	Exchange Opening Prices ..	20 mins.	5 Kw.
11	4.45	Eiffel Tower ..	FL 2650 m.	Paris ..	Exchange Closing Prices (except Saturday)	15 mins.	5 Kw.
12	4.45	Radio-Paris ..	CFR 1750 m.	Clichy ..	Concert ..	1 hour	4 Kw.
13	5.0	Leningrad ..	— 940 m.	Russia ..	Lectures, followed by News and Short Concert	8 p.m.	1.5 Kw.
14	5.0	Warsaw ..	— 580 m.	Poland ..	Concert ..	7 p.m.	1.5 Kw.
15	5.0	Frankfurt ..	— 470 m.	Germany ..	Lectures ..	7.30 p.m.	1.5 Kw.
16	5.30	Stuttgart ..	— 446 m.	Germany ..	Lectures ..	6.30 p.m.	1.5 Kw.
17	5.40	Brünn ..	— 750 m.	Czechoslovakia ..	Evening Concert ..	8 p.m.	1.5 Kw.
18	6.0	Hamburg ..	HA 392.5 m.	Germany ..	Lectures ..	7 p.m.	10 Kw.
19	6.0	Leipzig ..	— 452 m.	Germany ..	Lectures ..	7 p.m.	1.5 Kw.
20	6.0	Eiffel Tower ..	FL 2650 m.	Paris ..	"The Spoken Journal" (Lectures)	7.5 p.m.	5 Kw.
21	6.0	Union-Radio ..	EAJ7 373 m.	Madrid ..	Concert (2 alternate days a week)	8 p.m.	1.5 Kw.
22	6.0	Radio-Barcelona ..	EAJ1 325 m.	Spain ..	Concert, followed by News ..	7 p.m.	1 Kw.
23	6.15	Oslo ..	— 382 m.	Norway ..	Lectures ..	7 p.m.	1 Kw.
24	6.30	Stockholm ..	SHSA 428 m.	Sweden ..	Evening Concert ..	10 to 11	2 Kw.
25	6.40	Hilversum ..	NSF 1050 m.	Holland ..	Concert, preceded by News ..	9.10 p.m.	10 Kw.
26	7.0	Stuttgart ..	— 446 m.	Wurtemberg	News, followed by Evening Programme	10 p.m.	1.5 Kw.
27	7.0	Göteborg ..	SHSB 288 m.	Sweden ..	Evening Concert ..	9.30 p.m.	.5 Kw.
28	7.0	Malmo ..	SHSC 270 m.	Sweden ..	Evening Concert ..	9.30 p.m.	.5 Kw.
29	7.0	Sunsvall ..	SHSD 545 m.	Sweden ..	Evening Concert ..	9.30 p.m.	.5 Kw.
30	7.0	Boden ..	SHSE 1200m.	Sweden ..	Evening Concert ..	9.30 p.m.	1.5 Kw.
31	7.0	Oslo ..	— 382 m.	Norway ..	Time Signal, Concert and News ..	9 or 11	1 Kw.
32	7.0	Königsberg ..	— 463 m.	East Prussia	Concert and Late News ..	10 p.m.	2 Kw.
33	7.0	Hamburg ..	HA 392.5 m.	Germany ..	Concert, Late News and Dance Music	10 p.m.	10 Kw.
34	7.0	Lausanne ..	HB2 850 m.	Switzerland	Time Signal, Concert (Wednesdays excepted)	8.30 p.m.	300 Watts.
35	7.0	Copenhagen ..	— 357½ m.	Denmark ..	Concert, followed by news ..	1 to 3 hrs.	1 Kw.
36	7.0	Radio-Cadiz ..	EAJ3 360 m.	Spain ..	Concert, Time at 8 p.m. ..	9 p.m.	1 Kw.
37	7.0	Munich ..	— 485 m.	Bavaria ..	Concert and News ..	10 p.m.	1.5 Kw.
38	7.0	Bern ..	— 315 m.	Switzerland	Orchestral Concert ..	10 p.m.	1.5 Kw.
39	7.0	Radio-Wien ..	— 530 m.	Vienna ..	Evening Programme (Saturday till 10 p.m.)	8.30 p.m.	5 Kw.

Ref. No.	G. M. T.	Name of Station.	Call Sign and Wavelength.	Situation.	Nature of Transmission.	Closing Time or Approx. Duration.	Approx. Power used.
<b>WEEK DAYS (Contd.)</b>							
40	7.0	Prague ..	— 368 m.	Czecho-Slovakia	Concert, followed by News ..	9 p.m.	5 Kw.
41	7.5	Eiffel Tower ..	FL 2650 m.	France ..	Weather Forecast .. ..	7.20 p.m.	5 Kw.
42	7.15	Breslau ..	— 418 m.	Silesia ..	Lecture or Talk, followed by Concert ..	9 p.m.	1.5 Kw.
43	7.15	Zurich ..	— 515 m.	Switzerland	Lecture and Concert, followed by Late News ..	9 p.m.	500 Watts
44	7.15	Leipzig ..	— 452 m.	Germany ..	Concert and News (3 days a week until 10.30 p.m.)	9 p.m.	1.5 Kw.
45	7.15	Geneva ..	— 760 m.	Switzerland	Concert relayed from Hotel Metropole ..	9 p.m.	600 Watts.
46	7.30	Frankfurt ..	— 470 m.	Germany ..	Concert and News .. ..	10 p.m.	1.5 Kw.
47	7.30	Münster ..	MS 410 m.	Westphalia	Concert, followed by News ..	9.45 p.m.	3 Kw.
48	7.30	Voxhaus ..	B 505 m. and 576 m.	Berlin ..	Concert, followed by News and Weather Report, Dance Music ..	11 p.m.	1.5 and 4.5 Kw.
49	7.30	Budapest ..	— 546 m.	Hungary ..	Concert or Opera relayed ..	2 hours	2 Kw.
50	7.30	Eiffel Tower ..	FL 2740 m.	Paris ..	Concert .. ..	9 p.m.	5 Kw.
51	7.30	Konigswusterhausen	AFT 1300 m.	Berlin ..	Evening Programme relayed from Voxhaus on High Power ..	11 p.m.	18 Kw.
52	7.40	Unione Radiofonica Italiana	IRO 425 m.	Rome ..	Concert, followed by News and Dance Music ..	10 p.m.	1.5 Kw.
53	8.15	Royal Dutch Meteorological Inst.	KNML 1100 m.	Utrecht (De Bilt)	Weather Report .. ..	5 mins.	2 Kw.
54	8.0	Soro ..	— 2400 m.	Denmark ..	News Bulletin .. ..	8.30 p.m.	1.5 Kw.
55	8.0	Agen ..	— 318 m.	France ..	Exchange Quotations and News Bulletin (Concert Friday 8.30 p.m. to 10 p.m.)	15 mins.	250 Watts.
56	8.0	Milan ..	1Mi 320 m.	Italy ..	Concert .. ..	9 p.m.	1.2 Kw.
57	8.15	Radio-Beige ..	SBR 262 m.	Brussels ..	Concert, preceded and followed by News ..	10.10 p.m.	2.5 Kw.
58	8.15	Radio-Paris	CFR 1750 m.	Clichy ..	Detailed News Bulletin ..	8.30 p.m.	4 Kw.
59	8.30	Radio-Toulouse	— 441 m.	France ..	News, followed by Concert ..	11 p.m.	2 Kw.
60	8.30	Radio-Lyons ..	— 280 m.	France ..	Concert .. ..	10 p.m.	500 Watts.
61	8.30	Ecole. Sup. des Postes	FPTT 458 m.	Paris ..	Concert, sometimes preceded by Lecture ..	11 p.m.	500 Watts.
62	8.30	Radio-Paris ..	CFR 1750 m.	Clichy ..	Concert .. ..	10 p.m.	4 Kw.
63	9.0	Radio-Barcelona	EAJ 1 325 m.	Barcelona ..	Concert .. ..	2 to 3 hrs.	1 Kw.
64	9.0	Radio Club, Sevillano	EAJ 5-350 m.	Seville ..	Concert .. ..	10.30 p.m.	1.5 Kw.
65	9.0	Radio-Catalana	EAJ 13 462 m.	Barcelona ..	Concert, preceded by News ..	Midnight	1 Kw.
66	10.0	Radio-Vizcaya, Bilbao	EAJ 11 383 m.	Spain ..	Concert .. ..	Midnight	1.5 Kw.
67	10.0	Radio-Iberica	RI 392 m.	Madrid ..	Concert .. ..	2 to 3 hrs.	3 Kw.
68	10.0	Union-Radio ..	EAJ 7 373 m.	Madrid ..	Time varies to 4 p.m. and 6 p.m. on alternate days of month. Concert (not every evening) (alternate with Radio Iberica)	1 a.m.	2 Kw.
69	10.10	Eiffel Tower ..	FL 2650 m.	Paris ..	Weather Forecast .. ..	5 mins.	5 Kw.
70	10.44	Eiffel Tower ..	FL 2650 m.	Paris ..	Time Signal in G.M.T. (Spark) ..	3 mins.	60 Kw.
71	11.44	Nauen ..	POZ 3000 m.	Berlin ..	Time Signal in G.M.T. (Spark) ..	8 mins.	50 Kw.

**SUNDAYS.**

72	a.m. 8.2	Eiffel Tower ..	FL 2650 m.	Paris ..	Time Signal in Sidereal Time (Spark) ..	5 mins.	60 Kw.
73	8.40	Eiffel Tower ..	FL 2650 m.	Paris ..	Weather Forecast .. ..	10 min.	5 Kw.
74	9.10	Hilversum ..	NSF 1050 m.	Holland ..	Divine Service .. ..	10.40 a.m.	10 Kw.
75	9.26	Eiffel Tower ..	FL 2650 m.	Paris ..	Time Signal in G.M.T. (Spark) ..	3 mins.	60 Kw.
76	10.30	Konigswusterhausen	AFT 1300 m.	Berlin ..	Concert, relayed from Voxhaus ..	11.50 a.m.	18 Kw.
77	11.14	Eiffel Tower ..	FL 2650 m.	Paris ..	Time, Weather and Fish Market Quotations ..	10 mins.	5 Kw.
78	11.57 p.m.	Nauen ..	POZ 3000 m.	Berlin ..	Mid-day Time Signal in G.M.T. ..	3 mins.	50 Kw.
79	12.30	Radio-Toulouse	— 441 m.	France ..	Concert .. ..	5 mins.	2 Kw.
80	12.45	Radio-Paris ..	CFR 1750 m.	Clichy ..	Concert, followed by News ..	1.45 p.m.	4 Kw.

# Conscientious Constructors are Considering Chokes

*Given a Choke and a Transformer costing the same, the Choke will be certain to give much more faithful reproduction. Like all A.J.S. Receivers, the one chosen by Sir Oliver Lodge was choke coupled.*

**C**HOKES coupling on the L.F. side has not generally received the attention it deserves. Perhaps it is by reason of the fact that if a choke is used without due care in the choice of valves, necessary condensers and grid leaks, considerably less volume will result. If, however, valves of correct design are employed, there should be no falling off in signal strength.

Although this may not be obvious to all at first, it can easily be explained. Owing to the comparatively low impedance of the primary winding of the average transformer selling at a reasonable figure, low impedance valves must be used if good quality reproduction is desired. Now low impedance valves generally have a low amplification factor. The average good choke, and the one illustrated in particular, has a high impedance at all audio frequencies, therefore high impedance valves, valves whose amplification factor is generally high, should be used on the L.F. side, so that any loss of volume due to absence of the step-up effect of a transformer is compensated for by the high amplification obtained from the valves. The only position in a choke coupled receiver in which a low impedance valve should be used is the last position.

There is another great advantage in the use of chokes for L.F. coupling, and that is, a set so con-

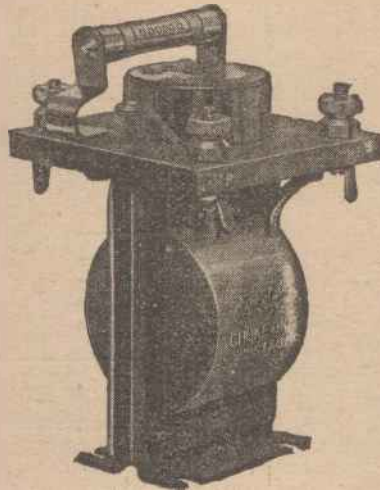

structed is not so liable to develop audio or L.F. "howls" even if three stages of amplification are used. While admitting that a correctly designed set should not "howl," many constructors may at one time or another have experienced much difficulty in this direction. The fact that a choke has only one winding, and a transformer two windings, makes a good choke a much more reliable piece of apparatus, and one less likely to break down.

The use of valves having a high amplification factor means that less drain is put on the H.T. Battery, whose life is consequently longer, and this means a direct saving, to say nothing of the saving in valve costs due to having to use a low impedance or power valve in the last position only.

The chief thing to remember is, that the valve with the loud-speaker in its plate circuit should be a low impedance power valve, any previous note magnifiers can be high amplification factor valves with considerable advantage.

If these instructions are adhered to, it will be found that the amplification with choke coupling is normally quite equal to transformer amplification, with considerable increase in purity.

Three types of Chokes are supplied:—

- (1) The Choke only.
- (2) A Choke Unit for the first stage of intervalve coupling. This Unit comprises the Choke, by-pass and coupling condensers and grid leak.
- (3) A Choke Unit for the second and subsequent stages of intervalve coupling, with coupling condenser and grid leak. These units only require the addition of a Valve-holder, Resistor and the necessary connections to complete a low frequency amplifier.

Choke only ... ..	15/-
Choke Unit, both stages ...	20/-

Publication No. 115 tells you all about chokes and the valves to use.

USE A.J.S. COILS  
AND  
VARIABLE  
CONDENSERS.

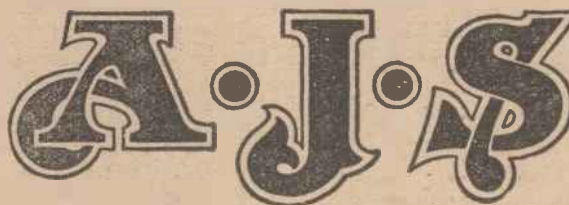

PUBLICATION No. 115  
IS OF INTEREST  
TO EVERY  
EXPERIMENTER

**A. J. STEVENS & CO. (1914), LTD.,**  
Radio Branch, WOLVERHAMPTON.

Telephone: 1748—(7 lines). Telegrams: "Reception, Wolverhampton."

**London Showrooms: 122/124, Charing Cross Rd., W.C.2**

Telephone: Regent 7161-2. Telegrams: "Ajayesco, Westcent, London."

**Glasgow Showrooms: 223, St. George's Road, Glasgow**

Telephone: Douglas 3449. Telegrams: "Reception, Glasgow."

**A. J. STEVENS & CO. (1914), LTD.,**  
Radio Branch, WOLVERHAMPTON.

Please send publication No 115.

NAME .....

ADDRESS .....

C./Mar./26.

Issued by the Publicity Dept. A.J.S.

In replying to Advertisers, use Order Form enclosed.

Your  
radio set  
can be  
improved  
by using

# B.T.H. VALVES.

Made in England

Insist on  
B.T.H. the  
Best of All

The British Thomson-Houston Co. Ltd.  
Crown House, Aldwych,  
London, W.C. 2.

SIX TYPES

R	0.7 A. 4v. 8/-	B3	0.35 A. 1.8v. 14/-	B4	0.25 A. 6v. 22/6
B5	0.06 A. 2.8v. 16/6	B6	0.12 A. 2.8v. 22/6	B7	0.06 A. 6v. 24/6



## An Additional Reason why the J.B. is the best condenser for you!

THE J.B. has always been synonymous with the best condenser efficiency.

Pre-eminent in design, construction and performance since broadcasting began; for these reasons alone the J.B. has continued to be the choice of discriminating constructors throughout the world.

And now the J.B. claims a further point of superiority in that it has the lowest losses yet measured in a radio condenser.

By an N.P.L. Test the .0005 Model J.B. was found to have a total loss of only .02 ohms at a million cycles. Sufficient proof that the J.B. is the best condenser for you.

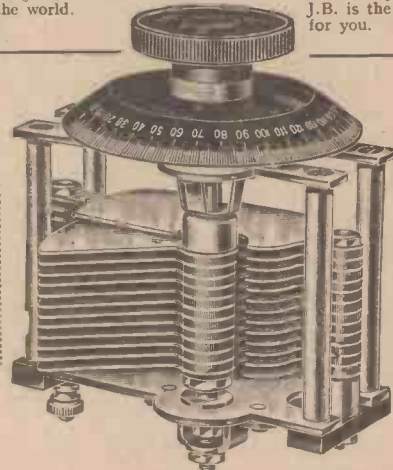

Pat. No. 247805.

J.B. LOW LOSS GEARED VERNIER (60 to 1).

001 - 17/6
00075 - 16/3
0005 - 15/-
0003 - 13/6
00025 - 13/3
0002 - 13/-
0001 - 12/-

J.B. LOW LOSS.

.001 - 13/-
.00075 - 11/9
.0005 - 10/6
.0003 - 9/-
.00025 - 8/8
.0002 - 8/6
.0001 - 8/3

# JACKSON BROS.

8, POLAND ST-OXFORD ST  
LONDON - W.1 Telephone -  
GERRARD 7414

(First Floor)

## ONE MASTER CONTROL

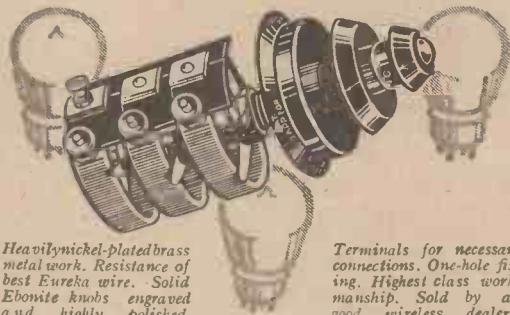

Heavily nickel-plated brass metal work. Resistance of best Eureka wire. Solid Ebonite knobs engraved and highly polished.

Terminals for necessary connections. One-hole fixing. Highest class workmanship. Sold by all good wireless dealers.

The MULTISTAT controls two or three valves. It saves panel space, simplifies internal wiring, adds to the appearance of the set, and is cheaper than the usual separate controls. Three independent knobs fixed to separate concentric spindles regulate the action of the contact arms. These arms engage on the resistance windings which are wound on a solid casting. Each resistance is thus controlled by its respective knob.

Made in the following standard units:—  
Type A Double Filament 7/6, Type B Treble Filament 11/6  
The resistance elements may be of 6, 8, 10, 25 or 30 ohms.

# MULTISTAT

The perfect filament control the—  
Patent No. 239,277. A Rayol Product  
ENGINEERING WORKS, (Electrical & General), Ltd.  
Regd. Offices: 7 and 8, Gl. Winchester Street, E.C. 2.  
Enquiries to: 17-21, Thurlow Park Road, West Dulwich, London.  
Phone: Streatham 2606.

Ref. No.	G. M. T.	Name of Station.	Call Sign and Wavelength.	Situation.	Nature of Transmission.	Closing Time or Approx. Duration.	Approx. Power used.
<b>SUNDAYS (Contd.)</b>							
81	4.30	Moscow	— 1450 m.	Russia	Concert and Lectures separated by short intervals	9 p.m.	1.5 Kw.
82	4.40	Bloemendaal	— 315 m.	Holland	Divine Service	2 hours	40 Watts.
83	5.0	Leningrad	— 940 m.	Russia	Lectures, followed by News and Short Concert	8 p.m.	1.5 Kw.
84	5.0	Malmö	SASC 270 m.	Sweden	Concert	7.0 p.m.	.5 Kw.
85	5.0	Warsaw	— 580	Poland	Concert	7 p.m.	1.5 Kw.
86	5.0	Radio Barcelona	EAJ1 325 m.	Spain	Concert, preceded and followed by News	9 p.m.	1 Kw.
87	5.15	Zurich	— 515 m.	Switzerland	Church Service, relayed from Neumunster	6.30 p.m.	500 Watts.
88	5.25	Hilversum	NSF 1050 m.	Holland	Church Service (Ned. Herv.Kerk)	7 p.m.	10 Kw.
89	6.0	Hamburg	HA 392.5 m.	Germany	Concert	7 p.m.	10 Kw.
90	6.0	Eiffel Tower	FL 2650 m.	Paris	"The Spoken Journal" (Lectures)	7.5 p.m.	5 Kw.
91	6.0	Brünn	— 750 m.	Czecho-Slovakia	Orchestral Concert	7 p.m.	1.5 Kw.
92	6.0	Helsingfors	— 318 m.	Finland	Concert	8.30 p.m.	750 Watts.
93	6.30	Voxhaus	B 505 m. and 576 m.	Berlin	Evening Programme, followed by Dance Music	11.0 p.m.	1.5 & 4.5 Kw.
94	6.30	Munich	— 485 m.	Bavaria	Concert	9.30 p.m.	1 Kw.
95	6.30	Königsberg	— 463 m.	E. Prussia	Concert	9 p.m.	2 Kw.
96	7.0	Oslo	— 382 m.	Norway	Concert, followed by Dance Music from Grand Hotel, Oslo	11 p.m.	1 Kw.
97	7.0	Bern	— 315 m.	Switzerland	Concert	9.30 p.m.	5 Kw.
98	7.0	Prague	— 368 m.	Czecho-Slovakia	Concert	9.0 p.m.	1 Kw.
99	7.0	Copenhagen	— 347.5	Denmark	Concert, followed by News	10 p.m.	1 Kw.
100	7.0	Radio-Wien	— 530 m.	Vienna	Concert	9.30 p.m.	5 Kw.
101	7.0	Lausanne	HB2 850 m.	Switzerland	Concert or Religious Talk	8.30 p.m.	300 Watts.
102	7.0	Hamburg	HA 392.5 m.	Germany	Concert, followed by Dance Music	10 p.m.	10 Kw.
103	7.0	Stuttgart	— 446 m.	Württemberg	Concert, followed by News	10 p.m.	1.5 Kw.
104	7.0	Breslau	— 418 m.	Silesia	Light Orchestra, Dance Music from 9.0 p.m.	10 p.m.	1.5 Kw.
105	7.0	Radio-Cadiz	EAJ3 360 m.	Spain	Concert, Time at 8.0 p.m.	9 p.m.	1 Kw.
106	7.0	Munster	MS 410 m.	Westphalia	Concert	10 p.m.	3 Kw.
107	7.5	Eiffel Tower	FL 2650 m.	France	Weather Forecast	7.20 p.m.	5 Kw.
108	7.15	Zurich	— 515 m.	Switzerland	Concert, followed by News	9 p.m.	500 Watts.
109	7.15	Geneva	— 760 m.	Switzerland	Religious Address	1 hour	600 Watts.
110	7.15	Leipzig	— 452 m.	Germany	Symphony Concert	9 p.m.	1.5 Kw.
111	7.30	Eiffel Tower	FL 2740 m.	Paris	Concert	9 p.m.	5 Kw.
112	7.30	Frankfurt	— 470 m.	Germany	Lecture, followed by Evening Programme	10 p.m.	1.5 Kw.
113	7.30	Budapest	— 546 m.	Hungary	Concert	9.30 p.m.	1.5 Kw.
114	7.30	Radiofonica-Italiana	IRO 425 m.	Rome	Concert, followed by late News	10 p.m.	3 Kw.
115	7.40	Hilversum	NSF 1050 m.	Holland	Concert	9.40 p.m.	10 Kw.
116	8.0	Radio Agen	— 318 m.	France	Weather Forecast and News	15 mins.	250 Watts.
117	8.0	Milan	IMI 320 m.	Italy	Concert	10 p.m.	1.2 Kw.
118	8.0	Soro	— 2400 m.	Denmark	News by "Berlingske Tidende"	8.30 p.m.	1.5 Kw.
119	8.15	Radio-Paris	CFR 1750 m.	Clichy	Detailed News Bulletin	8.45 p.m.	4 Kw.
120	8.30	Radio-Belge	SBR 262 m.	Brussels	Concert, followed by News	10.10 p.m.	2.5 Kw.
121	8.30	Ecole Supérieure	FPTT 458 m.	Paris	Concert or Lecture (May begin 15 mins. earlier or later)	11 p.m.	500 Watts.
122	8.30	Radio-Lyons	— 280 m.	France	Orchestral Concert	10 p.m.	500 Watts.
123	8.45	Radio-Toulouse	— 441 m.	France	Concert	11 p.m.	1.5 Kw.
124	8.45	Radio Paris	CFR 1750 m.	Clichy	Dance Music	10.30 p.m.	4 Kw.
125	9.0	Radio Club-Sevillano	EAJ5 357 m.	Spain	Concert	11 p.m.	1.5 Kw.
126	9.0	Radio-Catalana	EAJ13 460 m.	Spain	Concert, preceded by News	Midnight	1.5 Kw.
127	9.15	Petit-Parisien	— 345 m.	Paris	Concert (Items announced in English as well as French)	10.30 p.m.	500 Watts.
128	10.0	Radio-Iberica	RI 392 m.	Madrid	Concert (every alternate Sunday)	2 hours	3 Kw.
129	10.0	Union-Radio	EAJ7 373 m.	Madrid	Concert (every alternate Sunday)	1 a.m.	2 Kw.
130	10.0	Radio-Vizcaya	EAJ11 418 m.	Spain	Concert	11 p.m.	1.5 Kw.
131	10.44	Eiffel Tower	FL 2650 m.	Paris	Time Signal in Greenwich Mean Time (Spark)	3 mins.	60 Kw.
132	11.57	Nauen	POZ 3000 m.	Berlin	Time Signal in Greenwich Mean Time (Spark)	8 mins.	50 Kw.

Ref. No.	G. M. T.	Name of Station.	Call Sign and Wavelength.	Situation.	Nature of Transmission.	Closing Time or Approx. Duration.	Approx. Power used.
<b>SPECIAL DAYS.</b>							
133	3.45	Eiffel Tower ..	FL 2650 m.	Paris ..	Wed., relays P.T.T. Paris ..	5 p.m.	5 Kw.
134	5.0	Radio-Belgique	SBR 262 m.	Brussels ..	Tues., Thurs. and Sat., Concert, followed by News	6 p.m.	2.5 Kw.
135	7.30	Ryvang ..	— 1150 m.	Denmark ..	Tues., Wed. and Sat. Concert ..	9.30 p.m.	1 Kw.
136	8.30	Le Matin ..	CFR 1750 m.	Paris ..	Saturday, Special Gala Concert ..	11 p.m.	4 Kw.
137	9.0	Oslo ..	— 382 m.	Norway ..	Wed. and Sat., Dance Music from Hotel Bristol	10 p.m.	1 Kw.
138	9.0	Radio-Wien ..	— 530 m.	Vienna ..	Wed. and Sat., Dance Music ..	11.30 p.m.	5 Kw.
139	9.15	Petit-Parisien	— 345 m.	Paris ..	Tues., Thurs. and Sat., Concert (Items announced in English as well as French)	11 p.m.	500 Watts.

The following are Relay Stations:—

Kassel, 273.5 m., 1.5 kw., relays Frankfurt.  
 Elberfeld, 259 m., 1.5 kw., and Dortmund, 283 m., 1.5 kw., relay Munster.  
 Nuremberg, 340 m., 1.5 kw., relays Munich.  
 Gleiwitz, 251 m., 1.5 kw., relays Breslau.  
 Stettin, 241 m., relays Voxhaus.  
 Dresden, 292 m., 1.5 kw., relays Leipzig.  
 Bremen, 279 m., 1.5 kw., and Hanover, 296 m., 1.5 kw., relay Hamburg.  
 Graz, 387 m., relays Radio-Wien Sun., Mon., Thurs. and Sat.  
 Hjorring, 1250 m., and Odense, 950 m., relay Copenhagen; sometimes Ryvang.  
 Lyons La Doua, 480 m., Marseilles, 350 m., and Toulouse, 310 m., relay Ecole Superieure, Paris.

The following Swedish Relay Stations are now working, using 200 watts:—

Gavle, 208 m.; Umea, 215 m.; Eskilstuna, 243 m.; Saffle, 245 m.; Kalmar, 253 m.; Norrkoping, 260 m.; Jonkoping, 265 m.; Orebro, 237 m.; Trollhattan, 322 m.; Varberg, 340 m.; Karlstad, 355 m.; Falun, 370 m. (400 watts); Linkoping, 467 m.; Karlsborg, 1350 m.; and Karlskrona, 195 m.

These stations relay Stöckholm as a rule, but also occasionally one of the other four main Swedish stations.

## OUTSTANDING!

The outstanding feature of the Etherplus + Concerto L.F. Transformer is *tonal purity*.

If you want excessive resonance and mush you must use another transformer. Such harshness is *entirely* lacking in the Etherplus + Concerto.

Completely shrouded in nickel-plated case. One-hole fixing. Extra bracket for baseboard mounting.

Fixed Retail PRICE  
**12/6**

W/61 Ratio 1:5  
 W/62 Ratio 1:3  
 W/63 Ratio 1:2



Base Board Bracket (included)

If your dealer cannot supply, sent post free from address below. (Foreign postage extra)

**MANDAW**  
 9-15, Whitecross St.,  
 London, E.C.1

## 3 NEW PRODUCTS

Right up to the ORMOND Standard of efficiency. Reasonable in price and guaranteed to give every satisfaction

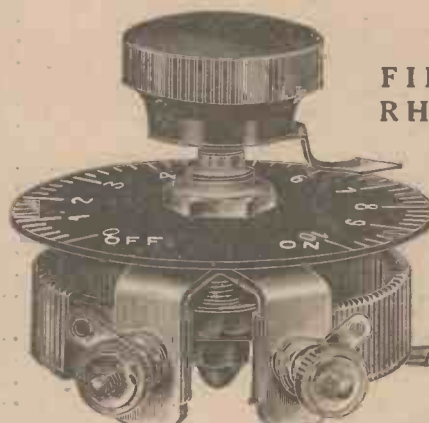

No. 5  
**FILAMENT RHEOSTAT**

Price

**2/-**

Supplied in either 6, 15 or 30 Ohms (as illustrated)

The "Ormond" DUAL RHEOSTAT } 2/6 each.  
 The "Ormond" POTENTIOMETER }

(Both these are of similar design to the Filament Rheostat)

All these three new products are supplied complete with knob-pointer and dial. From all Dealers.

**ORMOND ENGINEERING Co., Ltd**  
 199-205, PENTONVILLE ROAD, KING'S CROSS, LONDON, N.1.  
 Factory - Whiskin Street, Clerkenwell, E.C.1.  
 Telephone:—Clerkenwell 9344, 5 & 6. 'Grams'—'Ormondengi, Kinross.'



# Simple Theory put into Practice

By C. P. ALLINSON.

An article showing how a few simple formulæ can be usefully employed.

In all the physical sciences we find that the pioneers in the various fields of research have left their names behind them in some manner so that they will never be forgotten. The unit of electrical pressure, the Volt, is called after the Italian scientist Volta, the Ampere after the French experimenter of that name, and the Joule, the unit of energy, serves to immortalise the name of one who did much towards the correlation of the various branches of science—mechanical, physical and electrical.

### Ohm's Law

Another worker was Ohm, whose name has been applied to the unit of resistance, and who is also known as the originator of the law known as Ohm's Law.

This states that the current in amperes flowing in any circuit supplied with a steady source of potential is equal to that potential in volts divided by the total resistance of the circuit in ohms, or, written in symbols,

$$I = \frac{V}{R}$$

where I =current in amperes.  
 V =applied potential in volts.  
 R =resistance in ohms.

Thus in Fig. 1 a battery V of 4 volts is connected so as to pass a current through a resistance R of 16 ohms. Then an instrument, placed in series to measure the current I, will show that  $\frac{1}{4}$  amp. is passing.

### Application

Let us now see how this law can usefully be applied to wireless. If, for instance, it is intended to use a 3 volt .06 amp. valve with a 6 volt battery, the question naturally arises what resistance filament rheostat to employ so as to control the valve. As we know the amount of current that is to be passed through the valve we can determine, by using Ohm's law, the total resistance of the circuit.

We know that I =.06 amp.  
 and V =6 volts.

$$\text{Since } I = \frac{V}{R}$$

$$\text{Then } R = \frac{V}{I} = \frac{6}{.06} = 100 \text{ ohms.}$$

The filament of the valve has a resistance that must be allowed for, and by using Ohm's law again, we find that the resistance of the filament is 50 ohms. Thus a filament resistance of 50 ohms is needed to allow only .06 amp. to pass when a 6 volt battery is being used. It should be remembered, however, that an accumulator when just charged will show somewhat more than 6 volts, and it is, therefore, safer to employ a resistance slightly larger than the value calculated. A convenient value in this case will be 60 ohms.

### Another Case

Suppose it is intended to run three .06 valves in parallel with one filament resistance when using a 6 volt battery. First of all, what current is required? Since the filaments are to be in parallel, three times the current will be taken from the accumulator, i.e., .18 amp. Then with a 6 volt battery the total resistance required in the circuit to pass this current will be  $33\frac{1}{3}$  ohms. Part of this resistance is represented by the resistance of the three filaments. Since these are in parallel the total resistance will be one-third of one filament resistance by itself, i.e.,

$$\frac{50}{3} = 16\frac{2}{3} \text{ ohms.}$$

A suitable value for the filament rheostat will thus be 20 ohms, which allows a sufficient margin.

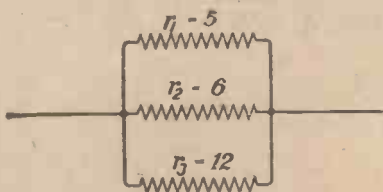

Fig. 2.—Resistances in parallel give a total resistance less than any of the individual resistances.

In a similar manner to that outlined above, values for filament resistances can be obtained in order to use valves of any

voltage and amperage with any battery having a voltage above that rated for use with the valve. Should it be noticed in any of these calculations that a negative value for the filament resistance is obtained, it will be found (provided that it is not due to any other error) that an attempt is being made to run a 4 volt valve from a 3 volt battery, and still pass the requisite current.

**High Resistances**

The possessor of a milliammeter is able to measure comparatively high resistances such as the resistance of a pair of telephones, a low frequency



Fig. 3.—Condensers in series or parallel are useful for many purposes.

transformer winding, etc. Suppose he connects the milliammeter in series with a 6 volt battery and the primary of an L.F. transformer, and that a current of 3 milliamps is registered.

$$\text{From } R = \frac{V}{I} \text{ we see that the total resistance}$$

of the circuit is 2,000 ohms. The milliammeter has, however, a resistance of, say, 400 ohms, therefore the resistance of the transformer primary is 1,600 ohms.

**Other Formulae**

There are other simple formulae that will be found useful by the wireless beginner in designing his receiver or in obtaining certain values when doing experimental work.

One of these enables the total equivalent resistance of a number of resistances placed in parallel to be determined. It is:

$$\frac{1}{R} = \frac{1}{r_1} + \frac{1}{r_2} + \frac{1}{r_3} \text{ etc.}$$

Fig. 2 shows three resistances of 5, 6 and 12 ohms respectively, connected in parallel. By applying the above expression, we find that the total resistance is equal to 2.22 ohms.

The total value of a number of resistances placed in series is a simple matter, for it is equal to the sum of the separate resistances; thus:

$$R = r_1 + r_2 + r_3 + r_4, \text{ etc.}$$

So the three resistances of Fig. 2 placed in series will offer a total resistance of 23 ohms.

**Capacities**

As the wireless experimenter has frequently to deal with inductances and capacities, it will be useful to know how to determine the resultant values of these when placed in series or in parallel.

Condensers placed in parallel will produce a total capacity equal to the sum of the capacities, a result which, it will be noticed, is the reverse of that obtained with resistances.

$$\text{Thus } C = c_1 + c_2 + c_3 \dots \text{ etc.}$$

But placed in series we find that:

$$\frac{1}{C} = \frac{1}{c_1} + \frac{1}{c_2} + \frac{1}{c_3} \dots \text{ etc.}$$

So the total capacity of several condensers placed in series will be less than that of the smallest condenser of the series.

To take practical examples, Figs. 3 (a) and (b) show three condensers placed first in parallel and then in series. Their values are .0003, .0005 and .001 μF respectively. From the above formulae we find that when placed in parallel the total equivalent capacity is .0018 μF, and when in series only .000158 μF.

This latter fact is useful to remember when a .0005 μF variable condenser is required and only a .001 available. A simple calculation shows that a fixed condenser of .001 μF in series would reduce the maximum value of the .001 μF condenser to .0005 μF.

**Inductances**

Inductances behave like resistances. When placed in series the total resulting inductance is equal to the sum of the separate inductances. But if connected in parallel we find that:

$$\frac{1}{L} = \frac{1}{l_1} + \frac{1}{l_2} + \frac{1}{l_3} \dots \text{ etc.}$$

It should be remembered when working with inductances and capacities that when calculations are made the same units must be used.



The Control Room of the new Birmingham Studio.





Shall I Scrap my  
 H.F. Transformer

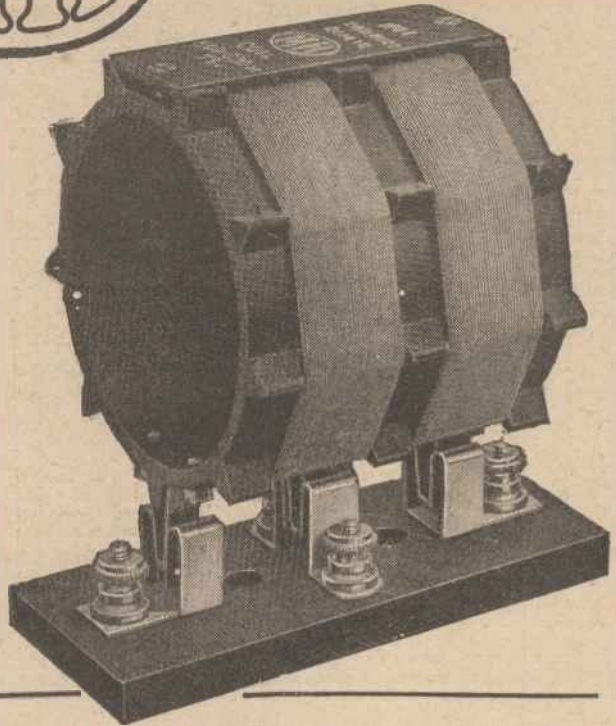
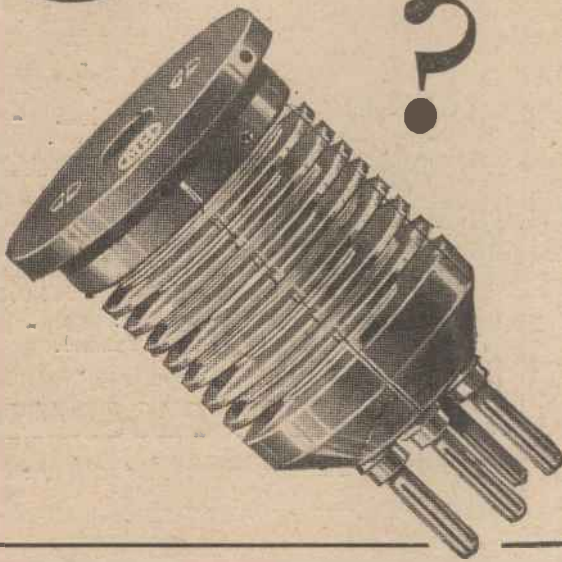

**F**OLLOWING on the introduction of the "DIMIC" Coil we have frequently been asked the above question. Our answer is given diagrammatically, from which it will be seen that the H.F. Transformer need not, and we think never will, be scrapped. It is a highly efficient device, supplementary to and not supplanted by, the "DIMIC" COIL.

If you desire a higher performance from your Set, spend a little more money on a further stage of H.F. amplification rather than replace your MH H.F. Transformers with "DIMICS." A full diagram for this is shown. It gives extraordinarily good results with

very high selectivity. At approximately 18 miles from 2LO we have frequently had Cardiff at Loud Speaker strength without any interference from 2LO when the latter was working—although adjustment for this is naturally very critical. Manchester at the same distance is comparatively easy to obtain and separate from London completely, even with the headphones on.

On two stations at a distance, and heterodyning each other, either station has been brought in at full Loud Speaker strength, clear from, but naturally distorted by, the other.

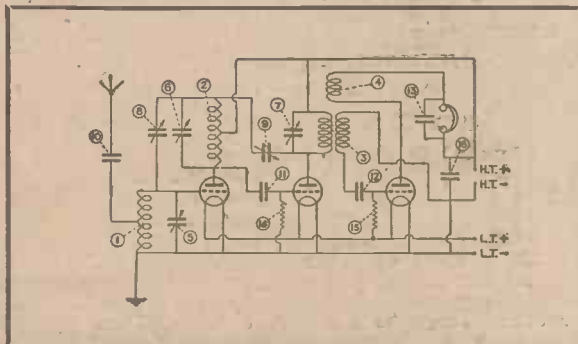

**"DIMIC" COILS**

are available in the following sizes:

- No.1 300/600 M.
- " 1a 450/950 M.
- " 2 600/1300 M.
- " 2a 900/2000 M.
- " 3 1100/3000 M.
- " 3a 2000/4500 M.
- Price 10/- each
- Base extra 2/6

**INDEX TO CIRCUIT DIAGRAMS.**

Item	Each Base
1 & 2 M.H. "Dimics"...	10/- 2/6
3 M.H. H.F. Barrel Type Transformer	10/-
4 M.H. Reactor	15/-
5 & 6 '0005 Variable Condenser	10/6
7 '0003 Variable Condenser	8/6
8 & 9 Neutralising Condenser	2/10
10,11 '0003 M.H. Mica & 12 Condenser	2/6 1/-
13 '001 Mica Condenser	3/- 1/-
14,15 M.H. Grid Leak, 1 megohm	2/6 1/-
16 '01 M.H. Mica Condenser	4/- 1/-

OUR ADVICE AND OUR PRODUCTS ARE EQUALLY GOOD  
 TAKE BOTH AND BE SATISFIED.

**L.M. MICHAEL LTD**  
 Manufacturers of Wireless and Scientific Apparatus  
 WEXHAM ROAD, SLOUGH, BUCKS.

Telephone:  
 Slough 441-442.

Telegrams:  
 Radiether, Slough.



## JUST AS YOU'D CHOOSE A PIANO

—so the sweet purity of tone and magnificent volume of the Claritone Loud-speakers will appeal to the music in your nature and influence the choosing of your loud-speaker.

The faithful reproduction and remarkable sensitivity of these instruments has made them favourites wherever they go and the results obtained are equal to many loud-speakers of considerably higher price.

### CLARITONE LOUD-SPEAKERS

Senior Model, 2,000 ohms, W.290.  
120 ohms, W.291. £5 0 0  
Junior Model, 2,000 ohms, W.295.  
120 ohms, W.296. £2 15 0

### CLARITONE HEADPHONES

W.216. 20/-

Sold by all Reputable Dealers.

Sole Distributors :

**ASHLEY WIRELESS  
TELEPHONE COMPANY**

NOTE OUR NEW ADDRESS

17 Finch Place, Falkland Street,  
London Road, = = = Liverpool.

## PORTABLE RECEIVERS

Each in its category the most powerful on the market

**NO AERIAL NO EARTH  
NO EXTERIOR CONNECTIONS**

**Duodyne PORTABLE III**  
Complete with Valves, Batteries and Royalties. Loud Speaker Range.

Self contained - 15-20 miles.  
With aerial - 150-200 miles.

£20 - 15 - 0

No Extras.



**Duodyne PORTABLE IV**  
Complete with Valves, Batteries and Royalties. Loud Speaker Range.

Self contained - 25-30 miles.  
With aerial - 250-300 miles.

£25 - 0 - 0

No Extras.

Duodyne Portable IV.

AND

## 30 ALTERNATIVE PROGRAMMES

Anywhere From Anywhere  
At Anytime

### THE CURTIS

Double Circuit Super-Het.  
**PORTABLE 8**

The World's Most Powerful Self-contained Receiver.

See "Daily Mail" issue Feb. 16th, Broadcasting Column,

Guaranteed Loud Speaker Range; with Self-contained aerial - 750 to 1,000 miles.

Price complete with all accessories and royalties,

£56 - 5 - 0

cash or deferred.

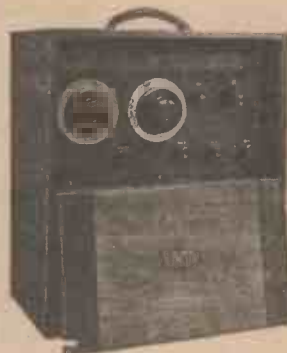

The Curtis Portable VIII.

*Generous price allowed for existing instrument if taken in part exchange.*

### BARGAINS.

1925 Receivers taken in exchange.

Marconi Scientific 5-valve enclosed £15 0 0.

Marconi V2 and 1 L.F. £6 15 0.

Sterling V3 enclosed £9 0 0.

Ethophone V enclosed £15 0 0.

Gambrell 4V £12 10 0.

Duodyne V open £15 0 0.

or £3 down and equal monthly payments.

For other bargains see list obtainable on application.

ALL COMMUNICATIONS TO

**PETER CURTIS LTD.**

75a, Camden Road,

London, N.W.1.

Telephone : NORTH 3112-3.

Telegrams : PARACURTEX

MANCHESTER : 312, DEANSGATE. Phone : Central 5095

GLASGOW : 47, CARRICK STREET. Phone : 6758

# Problems in Loud-Speaker Design

*A discussion of some of the factors which make for good reproduction in a loud-speaker.*

**I**T is a well-accepted fact that ordinary telephones of reputable make are capable of reproducing music and speech with much better quality than most loud-speakers (or loud-speaking telephones, to give them their correct designation).

### Objections to Telephones

In spite of this, however, there are disadvantages to the continued use of telephones when listening to the broadcast programmes, which necessitate the installation of loud-speakers in a large number of cases. To quote one or two of these disadvantages, we have the impossibility of carrying on a conversation between individuals without recourse to shouting, and the restriction of movement as governed by the length of the telephone cord between the head receivers and the receiving set. Again, there is the possibility of headaches due to the continual pressure of the ear-caps against the head, the likelihood of upsetting the receiving set by a sudden movement of one's person, and the natural abhorrence of some people to the use of telephones.

### Manufacturers' Problems

In view of the above-mentioned facts, it became necessary for manu-



A hornless pattern of loud-speaker.

facturers to turn their attention to loud-speaker construction, and with the natural impetus given by the rapid growth of wireless as a source of entertainment, much has been done to develop this side of the telephone industry. The loud-speaker, however, is still far from being a perfected instrument, so it will be useful to review the problems which have to be solved by the makers in order to reach a satisfactory level of reproduction.

We are not concerned in this article with the causes of distortion produced by the receiving set itself, as this has been explained by many writers, but we shall confine ourselves to a survey of the facts concerning the loud-speakers themselves and the cognate subject, the correct reproduction of sound.

### Developments in Loud-Speakers

Developments originally took place along the well-defined lines of telephone design, but the scale was naturally increased to allow full use to be made of the more powerful speech currents, with the attendant increased air displacement. This necessitated the addition of a horn to allow the air column to build up above the diaphragm. Now the air vibrations may be considered as produced in three ways, viz. :—

(a) Those given by the diaphragm through the action of the electric currents, (b) those imparted by the natural vibrations of the diaphragm itself, and (c) those imparted by the horn as a direct result of the vibrations of the air column which take place in it,

### The Electro-Magnetic System

It is well known that the basis of the loud-speaker is similar to that of the ordinary telephone, inasmuch as there is an electro-magnetic system consisting of a permanent magnet which attracts the mounted diaphragm, or reed connected to the diaphragm, while the speech currents pass through small coils on the magnet limbs and produce a varying magnetic field, which is superimposed on the existing steady magnetic field. It is necessary to design this system carefully so that the change in the magnetic field is proportional to the minute speech currents, and furthermore the deflection, or move-



For best results the horn must not be less than a certain length.

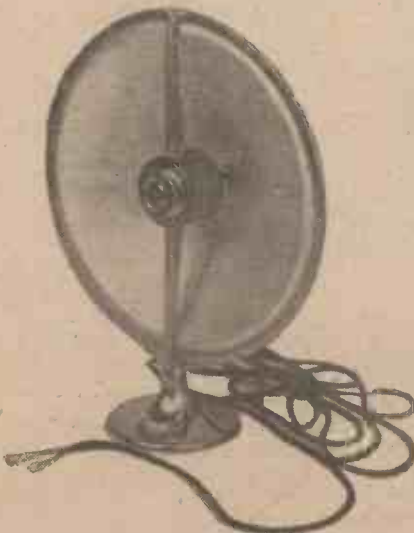

Another type of hornless loud-speaker.

ment of the diaphragm must be proportional to the field causing the deflection. If this is not done



The use of a straight horn has many advantages.

distortion in the reproduction of the speech or music is sure to take place.

**Magnetisation Curve**

It is possible to fulfil these conditions by working on what is known as the straight line portion of the "B H" curve (or magnetisation curve), a typical form of which is shown in Fig. 1. Any excursion into either the top or bottom bends will result in a loss of proportional reproduction. The length of the straight line portion of the "B H" curve will naturally depend on the amount of power to be handled by the loud-speaker.

The natural frequency of the vibrations of the diaphragm should be outside the acoustical range, or failing this, resort must be made to damping, the provision of rubber footed springs often serving to fulfil the latter condition.

If such precautions are not taken certain frequencies will be amplified out of proportion to their correct relative values, giving screeching and ringing effects.

**The Influence of the Horn**

The initial object of the horn is to act as an air container, and under these circumstances it will influence the quality of the sound least with a straight axis, neither reflecting nor responding to the sound waves produced in it. Of course, another function of the horn

is to direct the sound, and this is often done by cutting away and shaping the end, in the case of small vertical horns, so that the sound waves are bent round. If the horn fails to possess the correct shape, interferences will occur due to reflections, and the sound will be

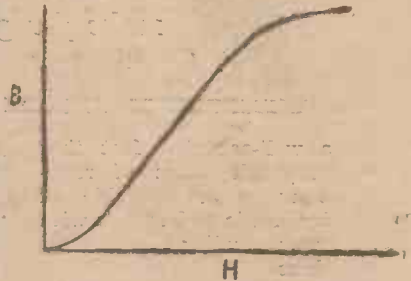

Fig. 1. — The relation between magnetising force and field strength is as shown above.

distorted or partially annulled. Experiments have proved that the best shape is secured when the opening increases with the length according to a logarithmic law. Attention must also be turned to the material employed in manufacturing the horn because of the damping produced by some materials.

Another "LOTUS" Triumph!

**The LOTUS**  
BUOYANCY  
**VALVE HOLDER**

Anti-Microphonic

Patents Pending

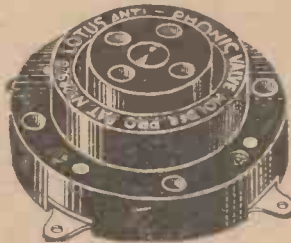

The delicacy of your Valve filaments is subject to microphonic elements from numerous sources. The LOTUS Buoyancy Valve Holder has been specially designed and constructed to counteract and dissipate these disturbances and will, by its original and unique spring construction, absorb any shock, protect your valves, and eliminate all microphonic noises.

PRICE **2/3**

**The LOTUS VALVE HOLDER**

is scientifically designed and made by the manufacturers of  
The LOTUS VERNIER COIL HOLDER

Obtainable from all reliable Radio Dealers.

Bakelite Mouldings  
Nickel Silver Springs and  
Phosphor Bronze Valve  
Sockets.  
Nickel Plated.

Valve Sockets and Springs  
are locked together by a  
mechanical process, mak-  
ing a definite and perma-  
nent connection.

**GARNETT, WHITELEY & CO., LTD.,**  
Lotus Works, Broadgreen Road, Liverpool.

REGISTERED  
**HUNTS**  
TRADE MARK

**THEY LAST LONGER**

GENUINE  
HIGH  
DRY

HELLESEN  
TENSION  
BATTERIES

For the first time this season we have a stock of the famous long life HELLESEN Batteries, and we are therefore advising customers immediately so that they may know that HELLESEN BATTERIES are available from stock for the first time in three years. Such a demand is in itself the best recommendation possible.

MORE EXPENSIVE THAN SOME OTHERS.  
THEY SELL ON QUALITY BECAUSE:—

**THEY ARE CHEAPER TO USE!**  
Delivery from Stock  
A. H. HUNT, LTD., Dept. No. 5, Croydon, Surrey.



Two typical horn loud-speakers.

**Enclosing the Diaphragm**

With the diaphragm enclosed, and provision made for a small

orifice, the air chamber can be regarded as a reservoir, and the air has a greater velocity in moving through the opening than inside the chamber itself. This results in an increase in audibility in the case of weak signals, and with the addition of a horn the increased velocity provides extra damping on the diaphragm.

**Length of the Horn**

The length of the horn is a factor to be borne in mind if good reproduction is to be assured. It can be shown that the best length should contain at least a quarter of the air wavelength, thus in the case of the middle C on the piano with a vibra-

tion frequency of 256, the air wave has a length of about 51 in., and, consequently, the minimum length

under these circumstances is about 13 in. If this was done all frequencies above middle C would be reproduced well, but lower frequencies would suffer slightly. That is to say, the high pitch notes with a short air wavelength would secure better reproduction than the low-pitched notes which have a long air wavelength. This effect can be noticed in small types of loud-speakers.

**Shaping the Horn**

Curving the horn subjects the sound waves to several reflections, but by a careful study of these problems it is possible to make a horn which reproduces speech and music in quite a good manner.

The writer knows of cases where a marked improvement in the quality of loud-speaker reproduction has been brought about by drilling holes, at appropriate intervals, in the curved part of the horn, but this method is not recommended to readers unless the aid of an acoustical expert is sought to give the necessary advice. Many types of hornless loud-speakers have now made their appearance on the market, and these are nearly all operated on what is termed the reed principle, and questions relevant to the influence of the horn naturally do not arise.

H. J. B. C.

**The COLVERN Low Loss SELECTOR**

The Colvern Selector Low Loss Reading to 1/3,600th capacity. Capacity .0005 mfd. £1 1s. - .0003 mfd. 21. Type E, without gear attachment. Capacity .0005 mfd. 15s. 0d. - .0003 mfd. 14s. 0d. One hole fixing. Other capacities if required. Descriptive folder upon request. Colvern Independent Variable - Price 2s. 6d. Ask your dealer also for the Colvern Low Loss Coil Former - Price 6s. 0d.

No hand capacity effects!

THE desired station tuned in; carefully it is brought up to maximum volume; you lift your hand from the dial and then—Hand capacity discounts all your patient tuning adjustments.

Just another reason why you should incorporate the Colvern Selector. In addition to the usual earthing plate an insulated spindle reduces hand capacity effects to an absolute minimum.

Using the Colvern you can tune with a degree of accuracy to 1/3,600th part of the variable capacity, and the removal of your hand from the dial will not affect the adjustment a fraction.

The Colvern Selector from every point of view should be your choice if you seek a variable Condenser of more than ordinary efficiency.

Your dealer stocks the Colvern!

COLLINSON PRECISION SCREW CO., LTD. Prov. St Works, Macdonald Rd, Walthamstow London E17 Telephone: Walthamstow 532

now try choke amplification

Given a good circuit with suitable valves you can demonstrate for yourself that choke amplification is decidedly superior to transformer coupling.

The result depends largely upon the efficiency of the Choke, and apart from our claim of the superiority

of the Success Super Choke it is significant that leading constructional experts repeatedly include it in their specifications.

This Success product embodies the essential features indicative of a good choke. It is wound with ample turns of large gauge wire upon an effective iron core.

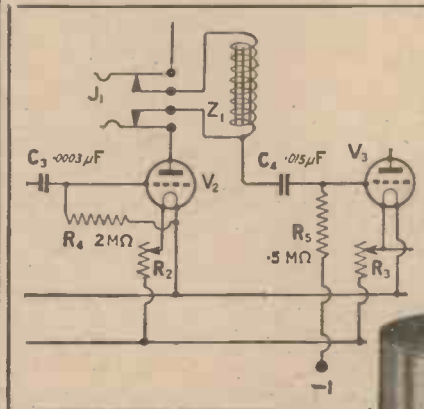

In the diagram we indicate the usual method of Choke coupling capacity.

With the Success Super Choke we claim that you can secure consistent amplification over audio frequencies—in fact, the power of reproduction and its remarkable mellow tone will be a revelation and immediately convert you to choke amplification.

SUCCESS SUPER CHOKE. Price 18/6

BEARD & FITCH LTD.

34, AYLESBURY ST., LONDON, E.C.1 And at 7, Dean Street, Piccadilly, Manchester.



# A Few Applications of the Thermionic Valve

THE average wireless enthusiast is apt to forget that thermionic valves have other applications besides those immediately connected with wireless reception and transmission, although perhaps we are justified in stating that the two last mentioned applications are by far the most important. It will be interesting, however, to review briefly a few of the uses to which this ingenious piece of apparatus has been put, in order to appreciate that the valve is not limited solely to radio communication.

### Valve Repeaters

The efficient amplification of speech telephone currents in long distance telephone trunk lines has

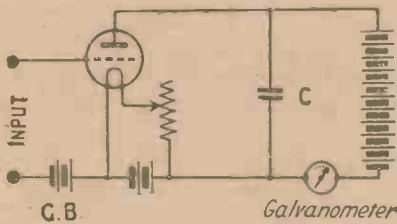

Fig. 1.—A circuit for measuring small alternating voltages.

been made possible by the valve. Due to the length of the cable and the various electrical constants involved, the speech currents become very greatly attenuated or reduced, and thermionic relays, or "repeaters" as they are popularly termed, are introduced at fairly regular intervals to amplify the speech to its initial degree of loudness. Added to this the weight of the cable has been reduced thereby, since cable of smaller section can be employed, so that this introduction has resulted in a saving of a large sum of money in the trunk telephone line.

### Aural Surgery

For aural surgery an adaptation of the principle of the valve as a generator of low-frequency oscillations has made it possible to deter-

mine how a person's hearing is responsive to certain frequencies. It is fairly well known that certain people have a "silent zone" at particular frequencies, and when the patient is fitted with a very sensitive pair of headphones it is possible to determine readily what frequencies are inaudible. Again, by varying this frequency, and using in conjunction a condenser and calibrated chart, the sounds can be reduced gradually to inaudibility, and so give the details for normal hearing, imperfect hearing, etc. This enables certain complaints to be accurately diagnosed and the resultant treatment can be more easily determined.

Again, the valve has been used with reasonable success for the simultaneous reproduction of speech with the projection of a film on a screen, and both the picture and sound vibrations are photographed simultaneously on the same film, thereby ensuring perfect synchronisation. The apparatus involved is somewhat complicated, and makes use of a light sensitive cell which possesses the peculiar property of resisting the passage of electricity in proportion to the intensity of light to which it is subjected.

### Small Alternating Voltages

When making measurements of small quantities difficulties are encountered through the absorption of power which introduces certain errors, and necessitates the use of correction factors, while the question of sensitivity often forms a limiting factor in many cases. With a thermionic valve, however, use is made of its property of converting a small alternating voltage change into a direct current change, which can be made to produce a deflection in a sensitive galvanometer. We have a direct application of this principle in the case of what is known as the Moullin voltmeter, which is quite a simple device. The instrument is really a calibrated valve detector, and two types may be used, the one which

takes a very minute power from the source to be measured employing anode current rectification. The circuit is indicated in Fig. 1, and needs a proper adjustment of grid bias and a large shunting condenser C for satisfactory operation. This type is less sensitive than that which makes use of the grid leak and condenser rectification, but this last named instrument suffers from the disadvantage of introducing quite a reasonable power loss into the circuit.

### Measuring Small Movements

To measure the small relative movements between two mechanical members without putting any constraint on the members themselves, Mr. H. A. Thomas, M.Sc., has invented a piece of apparatus which possesses great precision and sensitivity. Fig. 2 shows the apparatus in question, and the oscillations in the circuit  $L_1C_1$  are reduced by the absorption of energy through the medium of a moving plate in which eddy currents are induced. This metal plate has the virtual

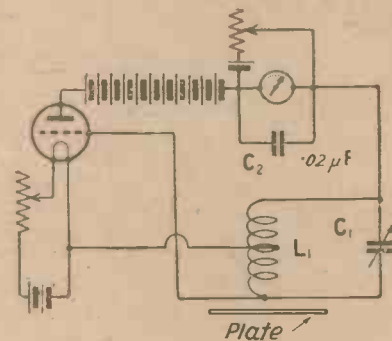
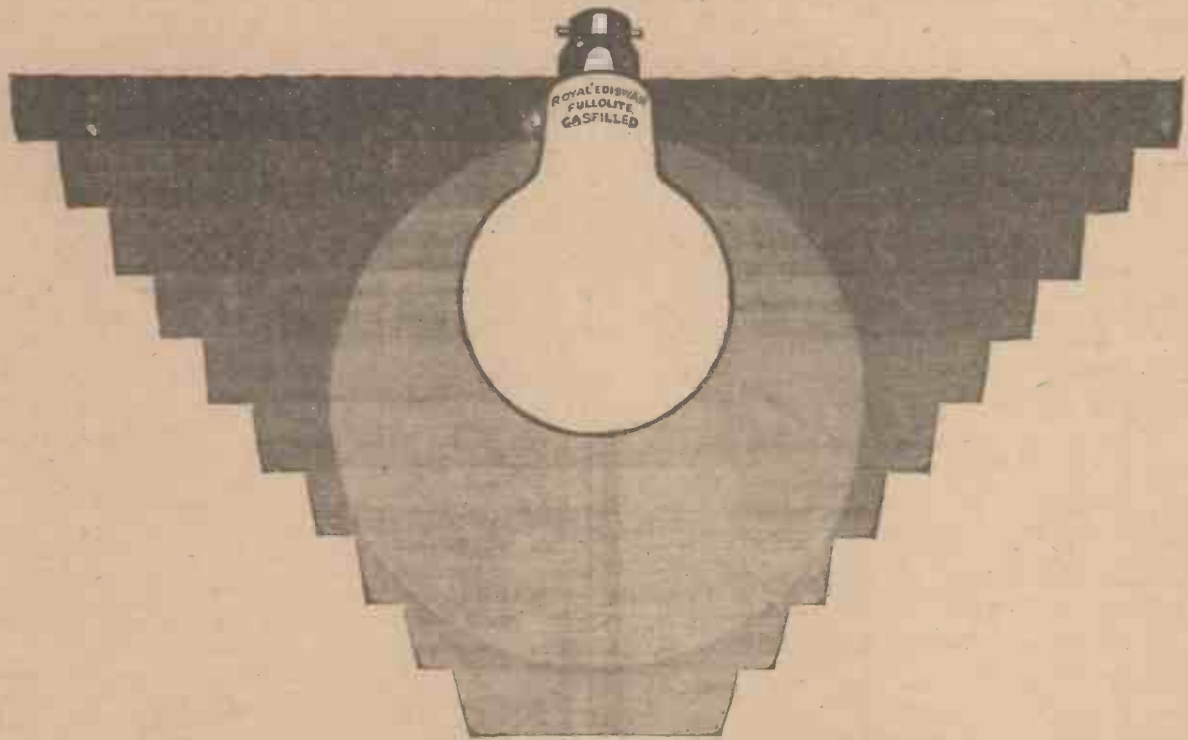

Fig. 2.—The theoretical arrangement of the apparatus for measuring small movements.

effect of increasing the high-frequency resistance of the coil  $L_1$ , and reduces the oscillating grid volts, thus bringing about a direct current change in the anode circuit. With a suitable adjustment and calibration the small relative move-



**LONGER DAYLIGHT  
IS NO REASON FOR NEGLECTING  
ARTIFICIAL LIGHT**

—is, in fact, good reason for giving more attention than ever to your lamps. Eyes that are accustomed to more daylight need an artificial light as close to sunny daylight as is possible.

*fit*

**ROYAL  
"EDISWAN"  
FULLOLITE**

**- LAMPS**

*and see things in a Clearer Light!*

Royal "Ediswan" Fullolite Lamps have genuine opal glass bulbs (not merely white-sprayed ordinary bulbs) which give perfect diffusion, and eliminate all risk of eye-strain. Further, an inner protective layer of clear glass provides an absolute safeguard against the "browning" effect of electric light on genuine opal glass. Decorative, dustproof and economical.

**IN ALL VOLTAGES : AT ALL ELECTRICIANS.**

*Fully Licensed under Patents Nos. 23765/12, 10918/13, and others.*

*In replying to Advertisers, use Order Form enclosed.*

# Constructors

GET THOSE COMPONENTS FROM US  
*it will pay you!*

*A prompt and reliable service which saves you time and trouble.*

**Just a Postal Order,**

with details of the components you require, ensures delivery by return.

All the leading makes of valves and components in stock.

**ORDERS FOR 10s. AND OVER POST FREE.**

Overseas orders and those under 10/- postage extra

Complete kits, including panels and cabinets, for sets described in this issue:—

The Neutrophase Four £12 - 7 - 6

The Melody Three £8 - 5 - 0

A Two Valve Receiver £6 - 3 - 0

Quotations by return for all your wireless requirements

**WILDER, DEVLIN & Co.,**  
31, QUEEN'S ROAD, BUCKHURST HILL, ESSEX.

# ELECTRICAL INSTRUMENTS



*The Sign of Accuracy.*

All Suprecision Instruments are guaranteed. They are used exclusively by leading Manufacturers, Engineers and Experimenters throughout the world. There are several hundred types and ranges to choose from. Illustrated Lists are sent free on request.

● Moving Coil Panel Instruments, all ranges	... ..	24/6
● Hot Wire Aerial Milliammeters, all ranges	... ..	12/6
● A.C. Switchboard Instruments	... ..	30/-
● High Frequency Unipivot Milliammeters	... ..	36/-
● D.C. Microammeters, all ranges and sizes, from	... ..	35/-
● Multi-range Radio Suprecision Testing Sets, 14 ranges complete in Cabinet No. 103	... ..	£5
● Multi-range Testing Sets, 8 ranges, for flush panel fitting, model 103...	... ..	55/-
● The world-famous Model 103, 8 ranges, fitted on sloping stand for Laboratory use	... ..	58/6
● The Suprecision "Continuator" for taking H.T. supply direct from the Mains, D.C.	... ..	42/-
● A.C. model "Continuator"	... ..	£3/15/-
● Rotary Converter Charging Boards, the highest efficiency and largest output of any type of rectifier, H.T. and L.T., complete from	... ..	£4/5/-

Make certain that your instrument bears the SUPRECISSION trade mark.

**F. C. HEAYBERD & CO.,**  
8/9, Talbot Court, EASTCHEAP, E.C.3.

'Phone: Royal 4682.

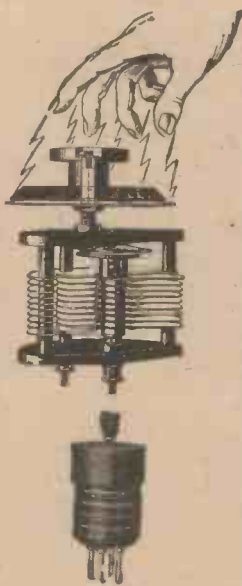

## VARIABLE CONDENSERS

Every Fulstop Condenser is unconditionally guaranteed to abolish all hand-capacity effects. In addition to being a square-law condenser, the Fulstop embodies a patent 2-1 gearing which allows very fine adjustment and accurate tuning. Made in 3 models from 8/3 to 30/6.

## H. F. NEUTRODYNE UNIT

A combination of a plug-in H.F. Transformer and a Neutrodyne Condenser. It is an invaluable component for Neutrodyne Circuits. Once set, it need not be altered, thus assuring better reception and saving time.

It does away with the necessity of drilling a fresh hole in the panel when a set is being converted to Neutrodyne. In cases where several stages of H.F. are used, this unit is the means of matching the transformers perfectly. Price 12/6.

## FIXED GRID LEAK

(1, 2 and 3 megs.)

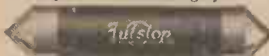

Guaranteed to be accurate and remain so. The element is an entirely new departure and has distinct advantages over any other.

Price 2/- each.

Stocked by most wireless dealers, but if any difficulty write to—  
**J. H. NAYLOR, LTD., WIGAN.**

**and now**

**The REFLEX COIL mounted!**

A combination of two such outstanding components as the Reflex Coil and the Reflex Coil Plug cannot fail to be appreciated by Wireless Enthusiasts who insist upon getting the utmost out of their sets.

This new addition to the Reflex family more than upholds its hereditary efficiency and its cost is remarkably low.

No. 25	2 8	No. 200	4 9
" 30	2 8	" 250	5 3
" 35	2 8	" 300	6 2
" 40	2 9	" 400	7 0
" 50	2 10	" 500	7 6
" 60	2 11	" 600	8 0
" 75	3 0	" 750	9 0
" 100	3 2	" 1000	10 6
" 125	3 6	" 1250	11 0
" 150	3 8	" 1500	12 0
" 175	4 3		

**REFLEX means BETTER RECEPTION**

From all good dealers. Get one for your set to-day.

REFLEX RADIO CO., LTD. 198, Lower Clapton Rd., London, E. 5. Phone: Clissold 4852.





## Stop that continued vibration of the filament!

USE the Clearer Tone Valve Holder and float your valves—secure from the ever-present, tone - destroying vibrations caused by street traffic, indoor footsteps and the hundred and one other microphonic disturbances. So thoroughly does this new holder cushion the valve that foreign noises are completely dissipated.

The springs, though delicately adjusted, are immensely strong and the tightest valve can be inserted without fear of damaging them. Each spring has one turn only. Bakelite construction of the body of the holder ensures high insulation, low capacity and sturdiness.

each **2/9**



There are terminal connections for the experimenter and soldering tags for the permanent set.

The springs themselves form the valve pin sockets. No soldered joints—all one solid metal piece fit in tag to valve leg. No flexible wire connections. The spring supports are not affected by stiff bus-bar wiring. For good reception with Dull Emitter Valves, Benjamin Clearer Tone Anti-Microphonic Valve Holders are essential.

each **2/9**



Patents Pending.

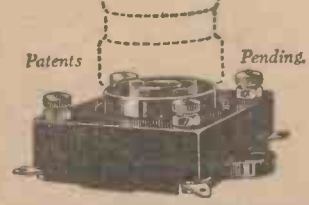

BRITISH **BENJAMIN** MADE  
**CLEARER TONE VALVE HOLDER**  
(ANTI-MICROPHONIC)

From your Dealer or Direct from  
THE BENJAMIN ELECTRIC Ltd.,  
Brantwood Works, Tariff Road,  
Tottenham, N.17.

The Benjamin Battery Switch gives perfect current control, 2/- each.

ments of the plate can be made to produce a large change in the anode current, and this method has been applied with success to the solution of problems connected with mechanical stresses.

### Maintaining Vibrations

A modification of this principle has made it possible to maintain springs or pendulums in a steady state of mechanical vibration, and is preferable to an ordinary type of contact maker, since the pull applied to the moving member is not sudden and only an infinitesimal decrement is added to the vibrating system.

No doubt other applications can be cited by the readers of this journal, and it is interesting to realise that while the valve makes the transmission and reception of broadcasting a pleasing reality it also has other physical applications which are of equal importance from the scientific point of view.

H. J. B. C.

### The Transatlantic Four

SIR,—I wish to thank Mr. Percy W. Harris for the excellent design of the Transatlantic Four-Valve set in the November, 1924, issue of MODERN WIRELESS. The results obtained in the short space of two months in building the set and getting the feel of the controls are remarkable. With a power valve added, making it a five-valve set, the local station can be heard very distinctly at sixty feet from the loud-speaker.

The following 1½ kw stations come in at fair loud-speaker strength and good headphone strength, Calcutta, about 600 miles; Colombo, Ceylon, about 1,100 miles. A few days ago between the hours of 1 a.m. and 3 a.m. local time, I picked up 5 XX, Daventry, but was unfortunately unable to get it clearly to take down the details in the programme. However, I hope to try again with a better aerial. My present one is situated on a very poor site electrically. I must congratulate Radio Press, Ltd., for producing such excellent periodicals on wireless. The Rangoon radio fans would commit suicide if the mails were to be delayed one week. Wishing you greater success in 1926.—Yours truly,

T. D. BOLDY.

Rangoon, Burma.



## Harry Preston's most enjoyable Tuesday evening —by himself.

WELL I remember the evening I built up my Pilot 3-Valve Set. Coming home tired and cold, my wife met me in the hall with the words— "There's a parcel from Peto-Scott's for you, Harry." "Good," I replied; "then we'll soon have some wireless music." "Perhaps," she laughed, "but not this week!" "You wait," I cautioned; "maybe even to-night."

After tea, I cleared the kitchen table, took off my coat, rolled up my shirt sleeves and commenced work. At 7 o'clock—one hour and a quarter after starting—I had assembled all the components on the panel. At 7.25 the base-board was complete and I had commandeered the family gas-ring for my soldering-iron.

Two hours later I had almost completed the wiring up—the diagram was so easy to follow. At five minutes past ten I had enlisted my wife's help in hitching up a few yards of bell wire around the picture moulding.

At 10.20 p.m. the great moment arrived. Would the Set work? "Bet you a box of State Express to a new hat," said my wife, hopefully, "that it won't." I donned the headphones—there was a moment's silence. Then... "Pay up," I grinned as I handed her the "phones." "Listen to the Savoy Orpheans."

And that's how I built my Pilot Set. No worry, no trouble—just an evening's pleasant work. I shall never regret sending for a copy of the Pilot Manual.\* That little book saved me pounds and put me on the right road for building my own Set.

\*Send 2d. and we will send you a copy of this splendid 56-page book. Full constructional details, circuit diagrams and many actual photographs.

## Pilot Sets for home Constructors

Sole Manufacturers:

**PETO-SCOTT Co., Ltd.,**  
Head Office: 77, City Rd., E.C.1.

Branches at: 62, High Holborn, W.C.1, and at  
Liverpool, Plymouth and Walthamstow.  
P.S. 4585

# And now the Cossor P.3

## Milestones in Valve History

### 1923—the Cossor P.1

—the valve which eventually became the standard British Bright Emitter.

### 1925 — the Wuncell

—the dull emitter which set new records for low working temperature.

### 1926 — the new P.3

—in which is announced for the first time a method of ensuring the true concentric mounting of the elements.

#### Technical Data

Filament voltage 4-4.5

Current consumption

175 amps.

High Tension voltage

50-150

Negative grid bias  $4\frac{1}{2}$

volts, if more than 100

volts is used.

Approximate impedance

8000 ohms.

Amplification Factor 8

22/6

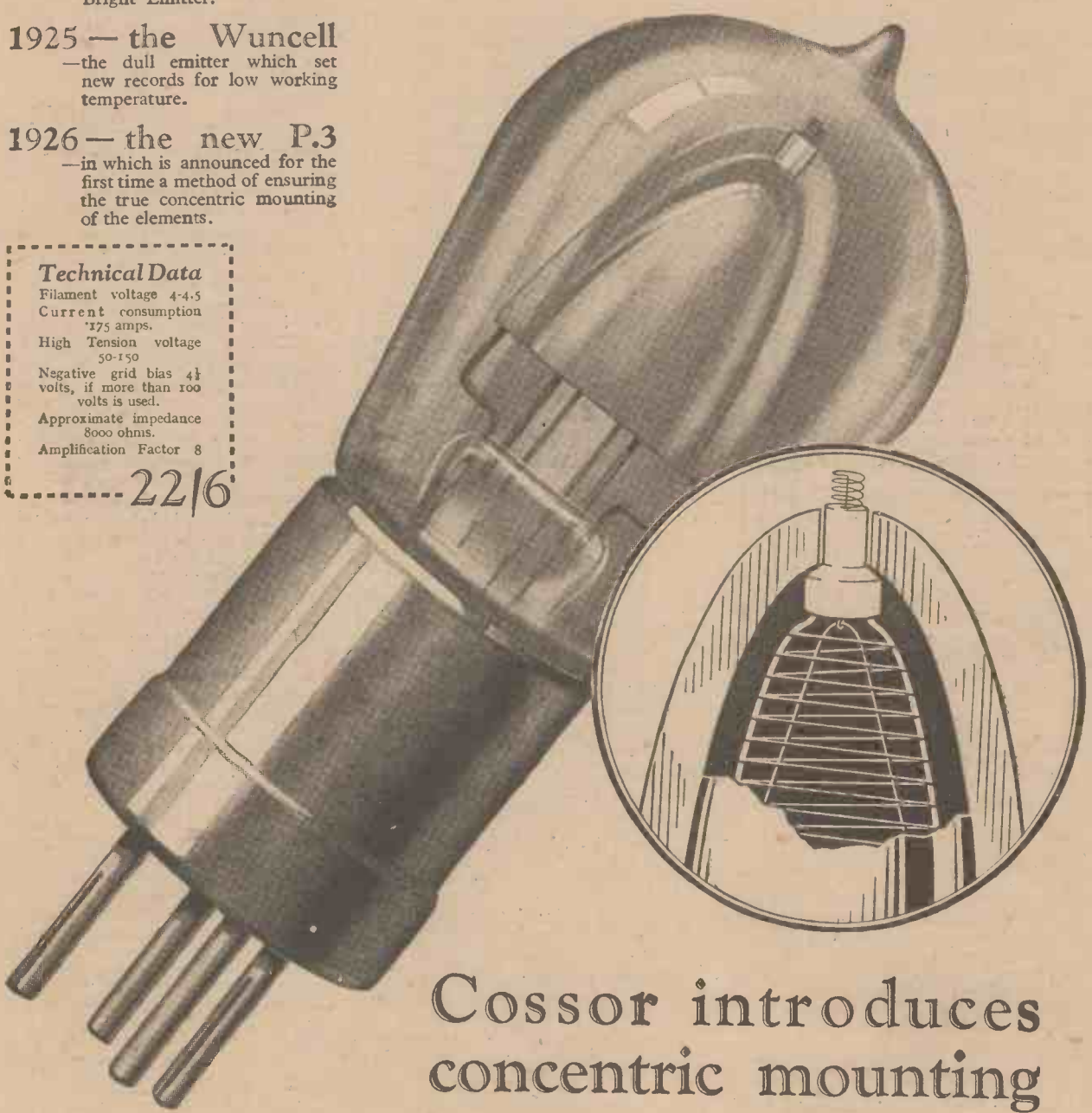

## Cossor introduces concentric mounting

# —incorporating new constructional features of paramount importance

THE great fundamental feature originally adopted in the P.1—the arched filament functioning within a hood-shaped Grid, the whole being surrounded by an electron-retaining Anode—has been consistently incorporated in every type of Cossor Valve. After three years it has not been found possible to improve upon this widely accepted principle. But in the new P.3 Valve there is utilised in addition a constructional feature which is likely to exert a far-reaching influence upon the whole future trend of valve design. We refer to the new method of automatically maintaining the filament, grid and anode in their exact relative positions during the whole life of the valve.

### What is this new system of concentric mounting?

Inserted at the top of the hood-shaped anode of the P.3 and projecting also through the top of the hood-shaped grid situated immediately beneath it, is a seonite tube. Through the centre of this seonite tube—which of course is a perfect insulator—runs a fine wire. One end is shaped to form a hook to act as an additional support for the filament, while the other is curved spiralwise into a spring. It will be obvious that the filament, grid and anode—in addition to the usual electrodes rigidly supporting them at the foot of the valve—are now inflexibly held in three distinct positions. Not even the hardest knock can disturb their relative positions.

### What are its advantages?

It is well known that any change in the relative position of the filament, grid and anode of any valve during its life will exert a profound effect upon its working characteristics. Let us explain it more fully in another way. Supposing three valves of the ordinary type (with straight tubular anodes) are assembled as follows: No. 1 has its filament, grid and anode mounted concentrically. No. 2 has its filament mounted diagonally through the grid—with-

out, of course, actually touching it. No. 3 has its filament mounted nearer to one side of the grid than to the other. What would be the result? All three valves although assembled from identical elements, would possess entirely different characteristics. Obviously such a lack of uniformity among these three

*WITH the rapid development of Radio the announcement of any new valve is of importance, but the first particulars of a new method of concentric mounting is certain to create intense interest among wireless enthusiasts throughout the country. Dating right back to the first Cossor valve in 1923—the famous P.1—each Cossor valve has possessed many exclusive features. It is a Cossor habit not to follow in the well-worn beaten track, but to pioneer improvements which will lead to greater efficiency.*

valves would prevent any Receiving Set using them from functioning as it should.

Actually, of course, the valve manufacturer aims to set the filament concentrically within the spiral grid, but after a while the filament sags and imperceptibly the valve begins to change in characteristic. No longer does it give the same good tone—no longer is it so sensitive to weak signals.

The inherent disadvantage of the straight filament has long been known to Cossor—indeed it was the earlier experience gained through the manufacture of R-type valves during the War that led to the introduction in 1923, after more than five years of incessant experimental work, of the now famous arched filament and hood-shaped grid and anode.

### What are the uses of the P.3?

Primarily this new P.3 is a power valve. That is to say it should be used in place of a general purposes valve after the Detector in any Receiving Set using bright emitter valves. Provided the set incorporates a good L.F. transformer and that a high tension voltage of from 100 to 150 is employed, an exceptional volume of pure mellow sound will

result. Every note in the harmonic scale will be faithfully reproduced. Even the bass notes—frequently harsh and unnatural—will be heard in their true value.

When the P.3 is used as an L.F. amplifier the Loud Speaker becomes richly endowed with a rare beauty of tone. Gone is the “tinkle tinkle” of the old gramophone, and in its place comes Music—real Music—just as the Old Masters would have us enjoy it.

### For Super-Hets., too.

Owing to its enormously greater emission and the new concentric principle of mounting, the P.3 is also eminently suitable for Super-Heterodynes and Neutrodyne. These receivers require, above all, valves which are absolutely uniform in their characteristics. One valve, not up to standard, will disturb the delicate balance of the whole Receiver and destroy not only

its sensitiveness but its selectivity as well.

### An economical Power Valve.

If you count the price of your valve in terms of life and maintenance—the business-like way—you'll appreciate that the P.3 is one of the most economical valves you can buy. Because it utilises the new Cossor triple-coated filament it functions at a dull red glow which is practically invisible in daylight. Heat—the culprit which brings most valves to an untimely end—is almost eliminated. The new concentric method of construction is responsible also for protecting the filament from shocks and jars. In fact, in so far as the filament—the only vulnerable part of any valve—is concerned, it is difficult to conceive any improvement.

Finally, the P.3 consumes only 175 amp. at 4 volts—less than one-fourth of the current required by the ordinary bright emitter. Taking into consideration its greater sensitivity and higher rate of emission, you'll agree that this is indeed a notable achievement. Get acquainted with this wonderful new valve and enjoy the pleasures of Broadcasting anew.

Wuncell Dull  
Emitters from  
14/- each.

# Cossor Valves

Cossor Bright  
Emitters now  
8/- each.

A. C. Cossor, Ltd, Highbury Grove N.5.

Gilbert Ad. 4558

In replying to Advertisers, use Order Form enclosed.

Figures to Remember



PETER PAN

— to be remembered

for the pleasure he gives, he has given, he will give. Besides there is the charm of his eternal youth. You want your valves to give you pleasure, to satisfy you: you would like them never to grow old. None will give you longer life or better service than 660 Valves. You have a wide range to choose from and each valve is specially designed to carry out its particular job.

There's the S.S.2 (Red Disc)—a 2-volt Valve for H.F. Amplification, suitable as a detector when followed by resistance or choke. Or again, the S.S.2 (Green Disc)—for L.F. Amplification—just the valve you want for small and medium-sized loud-speakers.

Now let's consider the question of economy. These valves have a current consumption of only 3 amps. and further work at such a low temperature that the life of the filament is immeasurably increased—surely economy in the true sense.

And this is only the beginning of our interesting story. The S.S.3 valves have a current consumption of only .06 amps., while with the S.S.7—a wonderful Dull Emitter Power Valve, current consumption .1 amp.—no glow from the filament is visible when operating at the correct voltage.

For long life, good service, perfect tone insist on SIX-SIXTY VALVES.



S.S.2 L.F.  
(Green Disc.)  
Voltage - 2 volts  
Consumption 3 amps.  
PRICE 14/-

Ask your Dealer for Leaflet S.S.1.7 for full particulars of complete range.

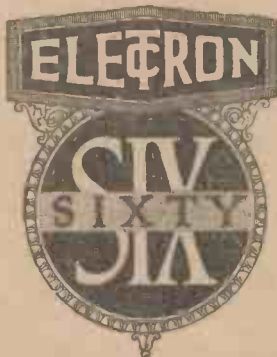

BETTER BY SIX TIMES SIXTY

The Elephon Co., Ltd., Triumph House 189, Regent Street, London, W.1.

TANGENT  
2-Valve Radiomatic RECEIVER



Here is an excellent product—The Tangent Two-Valve Radiomatic Receiver. This is manufactured specially to work with the new Daventry Station, and we claim that—even though it be a bold claim we can substantiate it—the Receiver obtains most satisfactory Loud Speaker strength up to 100 miles.

The whole instrument is designed and constructed according to Gent's best traditions.

Write for Leaflet.

Free on Request.



London: 25, Victoria Street, S.W.1.

Newcastle-on-Tyne: Tangent House, Blackett Street.

GENT & Co., Ltd., Faraday Works, Leicester.



PRODUCTS  
Guaranteed by Faraday House

THAT'S your cue: undoubtedly you must buy Therla Products when requiring Fixed Condensers or Grid Leaks. At no greater cost you obtain a product tested and guaranteed by this famous electrical Laboratory. Each Therla Condenser and Grid Leak is individually tested by Faraday House, and bears their guarantee to be correct to within a very narrow limit of its stated capacity.

You can obtain Therla Products from your dealer.

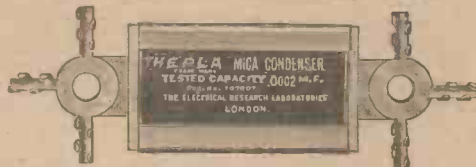

Therla Fixed Condensers  
PRICE: .0001 to .0015 mfd. 1/3 each. .002 mfd. to .006 mfd. 2/- ea  
Grid Condenser with Clips 1/3

Therla Grid Leaks  
Sizes 250,000, 500,000 ohms, and 1, 2, 3 megohms. Price 1/9.  
Grid Condenser and Leak 3/-

Sole Distributors:

SEL-EZI WIRELESS SUPPLY CO. LTD.

6 GREEK ST., LONDON, W.1, & 20, OLD HAYMARKET, LIVERPOOL  
Telephone Regent 1140 LIVERPOOL Royal 1682

BUY GUARANTEED PRODUCTS & BUY SATISFACTION

# How to Make a Useful Resistance Box

*A resistance box can be employed for many purposes by the wireless experimenter, and this article gives full constructional details for a box measuring up to 1,000 ohms.*

A RESISTANCE box has many uses on the experimenter's bench, and the following article shows how one may be constructed at a relatively small cost, which will be sufficiently accurate for most general purposes. The one described has a maximum resistance of 1,000 ohms, variable in steps of one ohm, but, of course, readers may make similar resistance boxes with values to suit their needs.

### The Resistance Coils

The actual resistances are coils of Eureka resistance wire, preferably D.S.C. We shall require ten resistances of 1 ohm, nine of 10

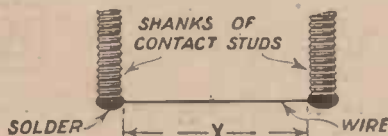

Fig. 1.—The exact length of wire must be soldered between the contact studs.

ohms, and nine of 100 ohms. The appended table gives the resistance in ohms per foot for various gauges of Eureka wire:

Gauge.	Resistance in Ohms per ft.
30	1.86
32	2.45
34	3.38
36	4.95
38	7.94
40	12.39

From this table the length of wire to give any resistance can be calculated. The wire used should be of as large a diameter as possible (compatible with a reasonable bulk for the resulting coil), for two reasons. First, the thicker the wire, the larger will be the current carried without overheating, and secondly, the thicker wire involves a greater length for a given resistance, so that any slight error in the measurement of the wire length will not have a great effect.

### An Example

For example, suppose we calculate the length of wire required for a 1 ohm coil, initially made from 30 gauge wire, and secondly from

40 gauge wire. The resistance of 1 ft. of 30 gauge wire is 1.86 ohms, so that we require  $12/1.86$  ins. for a 1 ohm resistance. This works out to be 6.45 ins. For the 40 gauge wire, the length required is  $12/12.39=0.97$  in. (approx.). It is obvious that to measure out the latter length to give the same accuracy as that of the thicker wire will be a matter of some difficulty.

### Recommended Sizes

The sizes recommended are: for each 1 ohm coil, 6.45 ins. of 30 gauge, for each 10 ohm coil, 24.24 ins. of 36 gauge, and for each 100 ohm coil, 96.85 ins. of 40 gauge. The wire should be cut into lengths about  $\frac{1}{2}$  in. longer than those given above, to allow for soldering to the contacts. It must be understood that the resistance of the coil will be that of the wire between the two points where it emerges from the solder, the wire embedded in the solder having no effect as far as actual resistance is concerned. Hence, in soldering the wire to the contacts, care should be taken to see that there is the exact length of wire required between the two soldered joints, and Fig. 1 should make this clear.

### Winding the Coils

Before soldering the lengths of wire to the contacts, they should be wound into coils. It is desirable to eliminate, as far as possible, any inductance of the coils, especially for alternating current measurements, since the presence of induct-

ance adds to the "impedance" of the coils. To accomplish this, the middle of the wire is found, and the wire is then doubled back on itself from this point, the wound coil then being similar in appearance to Fig. 2. A cylindrical former such as a pencil should be used, and after the coil has been wound the former should be withdrawn. The coils, being of insulated wire, and enclosed in a cabinet, may be allowed to hang freely behind the panel, and since they are entirely surrounded by air, any heat produced will be more easily dissipated than would be the case if the coils remained on a former.

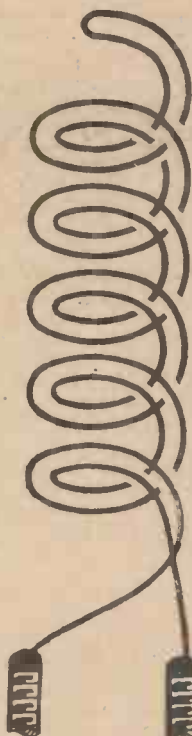

Fig. 2.—The coil is wound back on itself to avoid inductance effects.

### The Panel Layout

The panel layout is shown in Fig. 3 with all the necessary dimensions. The contacts are the usual brass studs ( $\frac{1}{4}$  in. diameter and  $\frac{1}{4}$  in. high) sold for wireless purposes, and the switch arms can be purchased complete. The studs are

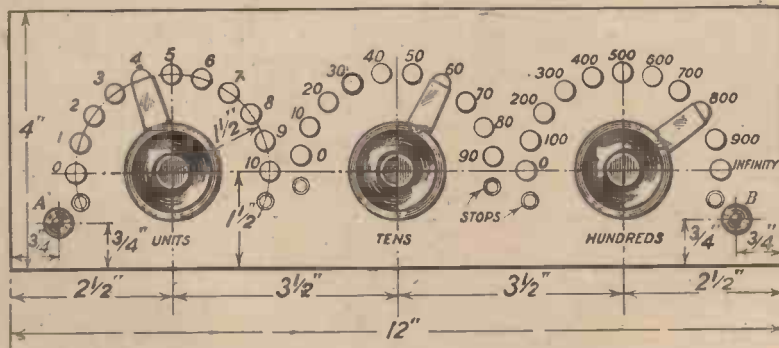

Fig. 3.—The panel layout is clearly shown in this diagram. Note the switch arm stops.

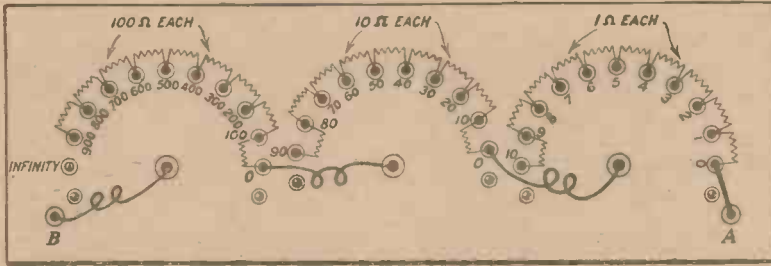

Fig. 4.—The wiring at the back of the panel is quite straightforward.

numbered in the manner indicated in Fig. 3. The connections between the terminals, switches, and studs, other than the resistance coils themselves, should be of very heavy flex, so that they have a negligible resistance, and all connections should be well soldered, with the same end in view.

**The Complete Resistance Box**

Fig. 4 shows the back of panel wiring. Stops are provided to prevent the switches being completely rotated and so putting undue strain on to the flexible connections. When all the coils are fixed in position the panel should be mounted in a suitable cabinet about 4 ins. deep to allow ample room for the coils to be disposed inside without crowding.

**A READER'S INTERESTING REPORT**

**A Buzzer Wavemeter**

SIR,—I thought you would be interested in a report of the "Modern Wireless Wavemeter," described by Percy W. Harris, M.I.R.E., in the February, 1925, issue of MODERN WIRELESS. I therefore submit mine.

At first the tuning was very flat. I used two honeycomb coils, No. 75 in the left-hand socket and No. 25 in the right-hand socket (looking from the front). Then I substituted a 12-turn hank coil, wound with 16 S.W.G. D.C.C. wire, in place of the No. 25.

Tuning was much improved and is sharp enough now for any pur-

pose. One degree either way will cut out the buzz from the wavemeter when the condenser is rotated. On the longer waves, I use a 300-turn Igranic coil in the left-hand socket, and a 35-turn coil of the same make in the right-hand socket. This gives tuning for Daventry and Radio-Paris. For higher wavelengths a 600 and a 100 coil are used, and these tune to the Eiffel Tower wavelength. On these lower frequencies the tuning is particularly sharp, requiring careful manipulation of the condenser to avoid passing the resonance point.

The receiver in use is the Anglo-American Six, about which I wrote a letter, published in *Wireless Weekly*, October 28th, 1925, and as this is such a sharply tuned receiver, a wavemeter is a boon in tuning in distant stations.

I felt that I ought to write to express my thanks to Mr. Harris for designing such an excellent and useful instrument.

In my opinion, if more wavemeters were used, the oscillation nuisance would be greatly reduced.

Again thanking you for the excellent results I am obtaining from this wavemeter,—Yours faithfully,

A. PRYOR.

Wallasey, Cheshire.

Get More out of Your Set!

**LOTUS Coil Holders**

are made from Bakelite mouldings with nickel-plated fittings; they are an ornament to any set and they give the best results. MOVING BLOCK CANNOT FALL.

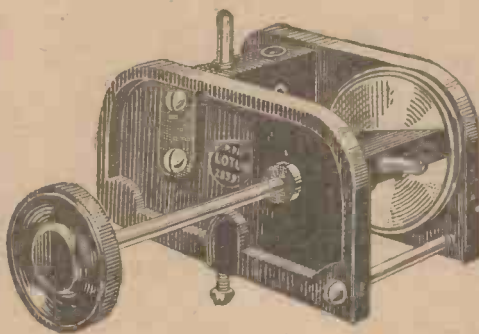

THERE ARE TWO TYPES OF LOTUS COIL HOLDERS.

For Outside Panel Mounting Two-Way, 7/- Three-Way, 10/6 For Inside Baseboard Mounting, with 6 in. handle, Two-Way, 8/- Three-Way, 12/6

The Vernier Movement is actuated by three sets of enclosed Precision Cut Gears, representing a reduction of 3 to 1.

**TESTIMONIAL**

"I should like to take this opportunity of saying how glad I am that I fitted your coil holder, I can now, without any other alteration to my set (Det. L.F.), receive 6 stations with comparative ease, where before, tuning in of 3 was an achievement."

**GARNETT, WHITELEY & Co., Ltd.,**  
Lotus Works, Broadgreen Road,  
**Liverpool.**

Cabinets are securely packed, insured and dispatched CARRIAGE PAID.

Artcraft "American"



Illustrated Brochure of Artcraft Cabinets 6 Models in Oak or Mahogany from 6/-, sent free on request.

**Cabinets of Distinction**

ARTCRAFT CABINETS, as specified in this issue, can be supplied in oak or mahogany, 14 in. by 7 in., Oak, 14/-; Mahogany, 19/-; 9 in. by 7 in., Oak, 6/-.

THE ARTCRAFT COMPANY, 156, Cherry Orchard Rd., Croydon. Phone: Croydon 1981.



**HIGH EFFICIENCY LOW-LOSS COUPLERS.**

These couplers are the most efficient and practical obtainable. Bank-wound turns, with or without variably coupled primary. Essential for extreme selectivity. 3-Circuit Tuner, variable primary ... 12/6 Oscillator Coupler ... 10/6

THE FORMO CO., (ARTHUR PREEN & CO., LTD.) Crown Works, Cricklewood Lane, London, N.W.2.



## Radio Press Envelope Receivers

### Some Appreciative Letters

**The "All-Concert de Luxe."**

SIR,—I am using the "All-Concert de Luxe" Receiver, described by Percy W. Harris, M.I.R.E., in Radio Press Envelope No. 4, which certainly deserves praise. Using 35, 50, and 75 coils respectively for aerial, anode and reaction, most B.B.C. stations are brought in with ease, while with 50, 75, and 100 coils I have picked up no less than six foreign stations in twenty minutes. Using 60 volts H.T. I have applied 1.5 volts grid bias, and I am using a variable grid-leak, both of which have increased the efficiency of the set. You may consider it worth while publishing a tip, which, had I previously known it, would have saved me the cost of three dull-emitter valves.

On the right-hand side of my set were the battery and earth terminals, the earth being next to H.T.+ . When taking off the H.T.+ lead I accidentally touched

the earth terminal with it, and, to my astonishment—a white flash! H.T.— and L.T.+ being a common terminal, it only requires, of course, H.T.+ on the earth terminal to complete the H.T. circuit across the filaments. Needless to say, my earth terminal has since been transferred.—Yours truly,  
T. H. COLWILL.

*Driffield.*

**The "Twin-Valve Loud-Speaker Receiver."**

SIR,—The "Twin Valve Loud-Speaker Receiver" described by Mr. J. Scott-Taggart in Radio Press Envelope No. 10, is now a well-known and popular receiver, but I should like to pay a further tribute to its efficiency.

Many of your readers may consider "Super Hets" or "Multi-Valve" set essential to an indoor aerial, but the enclosed results show that this is not necessarily the case.

Although I have handled dozens of receivers, as a "two-valver" the "Twin Valve" has not an equal.

The set has also been tested on outside aerials with splendid results.—Yours truly,

R. W. B.

*Romsey.*

Reception on indoor aerial (45 ft. copper ribbon loop).

Approx. distance.

	Miles.	Strength.
Bournemouth	... 30	R 8/9
	(L.S.)	
Cardiff	... 90	7
	(L.S.)	
Radio Paris	... 200	7
	(L.S.)	
Toulouse	... 550	6
Plymouth	... 125	4
	(Fading often.)	
Hamburg	... 550	4
	(When 6BM not working.)	
Daventry	... 110	8
	(L.S.)	
Birmingham	... 125	3
Liverpool	... 200	2/3
	(Fading often.)	
Berne	... 500	3/4
Cadiz and two other		
Spanish Stations	800	3/4
Dublin	... 230	3/4
	(When 6BM not working.)	

Above results obtained consistently.



A Eureka  
Radio Product

### Revolutionary in design and performance

**M**OST Sets fail to obtain selectivity through the use of inferior condensers. Two features are essential—low minimum capacity and the lowest possible losses. The Dialodenser is a multi-plate condenser, but instead of its plates being exposed to the air they are contained within a 2½" dial. Its minimum capacity is the lowest of any condenser. Its exclusive design ensures square law reading and permits a wonderfully high standard of efficiency. Smooth movement, one-hole fixing, permanent contact through armoured cable, long service, freedom from damage by dust—here are some exclusive Dialodenser features. Ask your dealer to show you one to-day, or get further particulars from us.



The Dialodenser will replace any type of Variable Condenser, and take up no room behind the panel.

10/-

.0003 mfd.s.  
.0005 mfd.s.

Portable Utilities Co. Ltd., 8 Fisher Street, W.C. 1

Also  
.001  
mfd.s.  
12/6

# Dialodenser

THE CONDENSER WITHIN THE DIAL

Gilbert Ad. 4573

# 1926

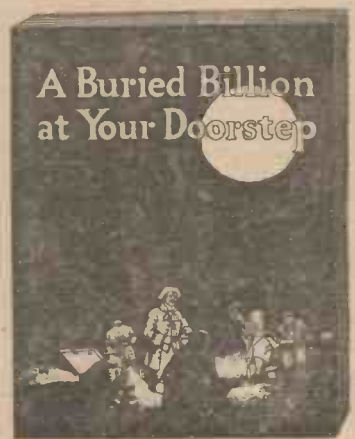

Our 1926 Catalogue of high-class American Radio Apparatus and circuit supplement is now ready.

Write immediately for your copy enclosing 9d. in stamps to cover cost of postage,

**R. A. ROTHERMEL LTD.**, Manufacturers and suppliers of all kinds of Radio Apparatus,  
24 & 26, MADDOX STREET, LONDON, W.1.

Telephone: Mayfair 578 and 579.



## Oscillating Without Interfering



UNLESS one possesses a set with really efficient high-frequency amplification preceding the detector valve, it is almost impossible to pick up distant stations without working dangerously near the oscillation point. Indeed, many hunters for distant stations deliberately make their sets oscillate, pick up the carrier wave, and then lessen the reaction coupling until the set is just below the oscillation point. This procedure probably causes the greater part of the "howling" set up by oscillating receivers, and it is welcome news to learn that Mr. Percy W. Harris has devised a sensitive two-valve set which can be made to oscillate

freely without the slightest fear of creating interference with others.

The "Huntsman Two," as this receiver is called, makes use of the Rice neutralising method and is described in the March issue of *The Wireless Constructor*. In the same issue Mr. E. J. Marriott gives full constructional details of a selective three-valve set which causes little interference to others even when oscillating. In the case of the "Two-in-One" receiver by Mr. Philip H. Wood, inexperienced members of the family may employ a crystal as detector followed by one or two note-magnifiers, while the more expert listener can switch over to a valve detector with re-

action circuit followed by one amplifying valve when he so desires.

Among the many other articles in the *Wireless Constructor* may be mentioned "Testing Your Receiving Set," by Mr. H. J. Barton-Chapple, in which the writer gives a few practical hints to enable the home constructor to locate and remedy possible faults, and "Erecting a 25-ft. Mast Single-handed," by Mr. A. V. D. Hort, which will interest those about to erect new or better aerials. A unique crystal set is also described, while constructional hints and notes abound as usual.

*Wireless*, the One-word Weekly, maintains its popularity with sound



**FORMO**  
ARTHUR PREHN & CO. LTD.

**FAMOUS SHROUDED 10/6 TRANSFORMER**  
New Catalogue Now Ready  
A full range of components of advanced design is described.  
The new Formo Components conform to the most recent practice, and satisfy all requirements of electrical and mechanical efficiency.  
British Ind. Fair. White City. Feb. 15  
**THE FORMO COMPANY.**  
(ARTHUR PREHN & CO., LTD.)  
Crown Works, Crickwood Lane, London, N.W.2.



**Athol**  
TRADE MARK

### THE VALVE HOLDER

for any Circuit, any Set, anywhere.

A marvel of Value at 1/3.  
Brackets for back-of-panel mounting, 2d. each extra.  
Porcelain Flexifonic Base for above, 1/3 each extra.

**ATHOL ENGINEERING CO.,**  
Seymour Road, Crumpsall, Manchester.

### "FIXQUICK" TERMINAL BLOCK

For Headphones or Loud Speaker

YOU need waste no time over connecting your Wireless Set. No matter whether you use SPADE or PLUG Terminals, or even if you have no Terminals at all, immediate connection can be effected with the



**"FIXQUICK"**  
You can fix 10 pairs as easily as one and disconnect any number without interference with the rest. It easily adapts itself to the set or to any extension. Moreover, there are no NUTS or SCREWS to break and twist your wires.

**3/- each.**

Ask your agent to show you one or send direct to:  
**H. MOORE, 35, Upper Green Lane, Lightcliffe, YORKS**

### CABINETS CASEWORK CABINETS

for your set for the circuits



Described in "MODERN WIRELESS," "WIRELESS WEEKLY," "WIRELESS CONSTRUCTOR," "WIRELESS," etc. etc.

**WRITE NOW FOR ILLUSTRATED LIST**

NAME \_\_\_\_\_  
ADDRESS \_\_\_\_\_

Write in Block Letters Please.

**THERE IS A CAMCO CABINET FOR EVERY CIRCUIT AND PANEL SUPPLIED TO FIT THE CABINET**

Telephone: Clarkanwell 6903.  
**CARRINGTON MANUFACTURING CO., LTD.**  
18/20, Normans Buildings, Mitchell St., Central St., E.C.1



theoretical and constructional articles. Of the valve sets described in recent numbers may be mentioned a "Two-valve Neutrodyne Receiver," by Mr. Stanley G. Rattee, in the February 6 issue, a selective two-valver by Mr. John W. Barber, in the following week's *Wireless*, and a novel one-valve set of very economical construction by Mr. Philip H. Wood, in the issue of February 27. In the February 20 issue, Mr. H. Bramford describes a variometer tuned crystal set designed solely for 5XX, while the February 6 number contains details of a local or Daventry crystal receiver by Mr. G. T. Kelsey.

The ideal which the broadcasting engineer always has before him can be summarised as the ideal of "straight lines," i.e., each piece of apparatus should have a uniform efficiency throughout the whole musical scale. Capt. A. G. D. West discusses these technical ideals in *Wireless* for February 13, while companion articles are "Is It Atmospheric?" by Mr. G. P. Kendall, and "Improvising a Wireless Set," by Mr. Percy W. Harris, the editor, who also writes on "Economy in H.T. Batteries," in the February 6 issue.

"Aerials a Mile High!" is the somewhat startling title of Capt. H. J. Round's article in *Wireless* for February 20. Mr. J. H. Reyner discourses on superheterodynes in the February 6 number, and in the same issue Mr. Stanley G. Rattee writes on "Practical Tips to Remember."

Experienced constructors know that, given a really effective method of reaction control, a simple valve detector is capable of remarkable long-distance results. "Reinartz" control is used by Mr. John W. Barber in a three-valve receiver he describes in *Wireless Weekly* for February 3, and selectivity is obtained by the incorporation of a wave-trap.

In the same issue two writers deal with the companion properties of tuned circuits, Mr. J. H. Reyner devoting his attention to "Screening and Tuning Coil Efficiency," while on the "capacity" side Mr. H. J. Barton-Chapple writes on "Where are those Condenser Losses?"

The last-named author in *Wireless Weekly* for February 10 discusses various methods for plotting coil fields—a subject which is of considerable importance in set de-

sign. Loud-speaker distortion and short-wave experiments are other subjects dealt with, while Mr. Harris describes a T.A.T. low-frequency amplifier for weak signals in the same issue.

Commencing on February 17, the price of *Wireless Weekly* has been reduced to 3d., but no alteration in size has taken place. On the other hand the quality of its contents has become even better than before, and the February 17 issue contains details of a three-valve receiver by Mr. Harris, incorporating two stages of H.F. amplification and employing twin-coil transformers having practically no external field. Capt. H. J. Round deals with Transformer and Resistance Coupling for L.F. amplification, while Capt. A. G. D. West confines his attention to Resistance Amplifiers and Tone Control.

A very interesting article is that by the Editor, Mr. John Scott-Taggart, entitled "Some Interference Problems in Superheterodyne Receivers"; while the Technical Editor, Mr. J. H. Reyner, and Mr. G. P. Kendall provide further articles to make the February 17 issue an exceptionally good number—and all for threepence!

## Salient "Simplicity Three"

An ultra simple Receiver with only two tuning controls, gives perfect loud-speaker reproduction, all batteries self-contained, automatic switching, covers Wave Band from 175 to 4,000 metres.

Price £22 - 15 - 0  
complete with £5 Loud Speaker.

Complete set of Components, Cabinet, Blue Prints and Instructions, £10. Marconi Royalty, 37/6.

You will find our List, "SALIENT FEATURES" of the utmost interest.

"S. A. CUTTERS" Ltd.

Price 6d.

18, BERNERS STREET,  
LONDON, W.1.

(Refunded on  
first purchase.)

Telephone : Museum 6273



## "TURRET" MASTS



COLUMBIA FLAMER MASTS BY NAVAL EXPERTS  
30 ft. Turret Mast. £1 19 6 | 22 ft. Telescopic 4 4 0  
27 ft. Turret Two 2 4 6 | 45 ft. Telescopic 4 10 6  
40 ft. Turret Three 2 18 9 | 33 ft. Super 6 19 6  
SIMPSON & BLYTHE, 6-9 Sherwood St., Piccadilly, W.  
Phone: Gerard 2350.

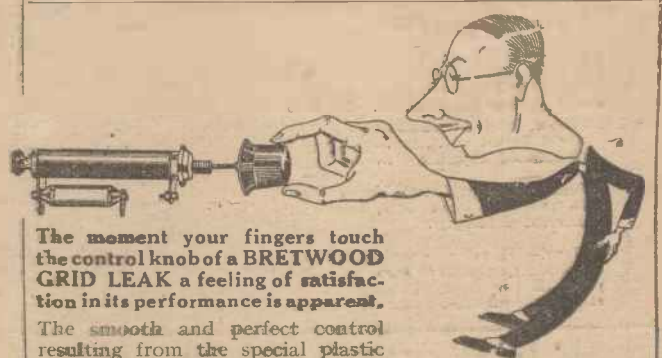

The moment your fingers touch the control knob of a BRETWOOD GRID LEAK a feeling of satisfaction in its performance is apparent.

The smooth and perfect control resulting from the special plastic resistance and the use of the best quality materials only in their construction enable us to guarantee them for three years.

The Bretwood Grid Leak gives accurate readings consistently from 50,000 ohms to over 10 megohms. Bretwood Grid Leaks have been used in several sets described in "Radio Press" publications. See page 469 of March issue of "The Wireless Constructor."

The Bretwood Variable Grid Leak and Anode Resistance (Patent No. 224295)

GRID LEAK OR ANODE RESISTANCE With Condenser (as illustrated) 4/-. Postage 3d.

Price 3/-

BRETWOOD LTD. 12-18, London Mews, Maple St., London, W.1.

"BRETWOOD" COMPONENTS are guaranteed for three years.

They include:

THE "BRETWOOD" FLAMER RESISTANCE

Price 3/6. Postage 3d.

THE "BRETWOOD" ANTI-CAPACITY VALVE-HOLDER.

Price 1/6. Postage 3d.

THE "BRETWOOD" ANTI-CAPACITY SWITCH.

Price 5/-. Postage 3d.

**MAGNUM**



**SPECIAL H.F. TRANSFORMERS.**

As used in the D.X. 5 described in MODERN WIRELESS (December issue). Price per set of 3, including mounting brackets, £1 17s. 6d.



**MAGNUM TERMINAL PANELS.**

As used on several Radio Press Sets. Drilled and engraved, fitted with 7 terminals, 4/6.

Ditto as above, but NOT engraved (drilled only), supplied in any length up to 24 in. (Terminals are spaced 1 in. apart.)

Price 6d. per Terminal.  
E.g.—12 in. Terminal Strip, 6/-  
With Terminals.



**4-VALVE FAMILY RECEIVER.**

As fully described in Radio Press Envelope No. 2. A highly efficient and popular set at a moderate price.

Complete Set of Components... £9 5 0  
As above, Ready Wired and Aerial Tested ... £11 15 0  
Plus Marconi Royalties ... £2 10 0

Send stamp for Latest Lists dealing with 15 Radio Press Sets, and new Illustrated Catalogues.

NOTE.—Where a complete set of components, together, with a drilled panel, is purchased, Royalties at the rate of 12/6 per valve holder are payable.

**MELODY 3-VALVE RECEIVER.**

As described in this issue by Percy W. Harris.

- 1 Cabinet and Baseboard, as described ... £2 0 0
  - 1 Ebonite Panel, 21 by 7 by 1/2 drilled ... 0 16 0
  - 3 Lotus Antiphonic Valve Holders ... 0 6 9
  - 1 Ferranti L.F. Transformer Type, A.F.3 ... 1 5 0
  - 1 Marconiophone Potentiometer ... 0 9 0
  - 1 Popular Variable Condenser "0005 ... 0 10 6
  - 2 Popular Variable Condenser, "0003 ... 1 0 0
  - 1 L. and P. Vernier 2-Coil Holder ... 0 8 6
  - 1 Magnum No. 1 Terminal Panel ... 0 4 6
  - 2 Magnum Single Coil Holders ... 0 3 6
  - 1 Watmel .0003 Condenser and 2 Ω Leak ... 0 3 0
  - 3 C.A.V. Filament Rheostats ... 0 15 0
  - 2 Jacks. No. 63 ... 0 5 0
  - 1 Plug ... 0 1 6
  - 1 Connecticut On and Off Switch ... 0 2 0
  - 4 Belling Lee Terminals ... 0 3 0
  - 1 Polar Vernier Condenser ... 0 5 6
  - 4 Decko Indicators ... 0 1 6
  - 2 Coils, Glazite ... 0 2 3
  - 1 Set Radio Press Transfers ... 0 0 6
- £9 3 0



**Introducing a New Magnum Product. APERIODIC H.F. TRANSFORMER.**

H.F. Amplification Simplified. By the use of this Transformer a stage of H.F. may be added to your set without an additional tuning control.

Supplied in the following ranges —  
Range "A" Aperiodic 300/600  
" " "B" " 550/1200  
" " "C" " 1100/3000  
Price 10/0 each.

**AN ANNOUNCEMENT. THE NEW MAGNADYNE.**

An improved design of the Magnadyne Super-Het incorporating several unique features will be ready shortly. Let us register your name for particulars, which will be sent when ready.



**THE D.X. 5.**

As described in December and January Issues of MODERN WIRELESS.

**A Highly Selective Set.**

Eliminates 2LO at 1 1/2 miles, and receives B.B.C. and Continental Stations on the Loud Speaker.

Complete Set of Components... £19 10 0  
As above, Ready Wired and Aerial Tested ... 22 0 0  
Plus Marconi Royalties ... 3 2 6

**MAGNUM TERMINALS.**

High-grade terminals 2 B.A., with drilled stems, nuts and washers, supplied in the following finish: Oxydised Cop per Lacquered Brass, Nickel Plated.

Price 3/- per doz.

**MAGNUM FLEX LEADS.**

Neat and convenient Leads, 7-way, for H.T., L.T., and Grid Bias, to suit Magnum No. 1 Terminal Panel, 3/6



**ALL CONCERT DE-LUXE RECEIVER.**

As fully described in Radio Press Envelope No. 4.

Complete Set of Components £9 4 6  
As above, Ready Wired and Aerial Tested ... 12 15 0  
Plus Marconi Royalties ... 1 17 6

**BURNE-JONES & CO., LTD.,**

MAGNUM HOUSE, 296, BOROUGH HIGH STREET, LONDON, S.E. 1.  
Telephone: Hop 6257. Telegrams: Burjomag, Sedist, London.  
Cables: Burjomag, London. Trade Enquiries Invited.



**The "PELICAN" UNIVERNIER**

Fits any Condenser and makes just that difference in fine tuning that you need to be certain of bringing in the station you really want.

Fit Pelican Univerniers in place of your present variable condenser dials and you will secure reliable micro-selective tuning.

Price 6/-

Obtainable from all Dealers.

**CAHILL & CO., LTD.,** 64, NEWMAN ST., LONDON, W.1.

H.P.A.11.



**Two in One!**

The new Dual Rheostat — a "Peerless" product in every way. Specially designed to meet the demand for a resistance equally applicable to bright or dull emitters. It has two windings — one offering a resist-

ance of 6 ohms, whilst a continuation of this is of 30 ohms resistance. The resistance element is wound on a hard fibre strip under great tension. One hole fixing is provided and the terminals are placed in convenient positions. The contact arm has a smooth, silky action, and all metal parts are nickel-plated.

**3/9 PEERLESS 3/9 DUAL RHEOSTAT**

Ask your Dealer send direct.

**THE BEDFORD ELECTRICAL & RADIO CO., LTD.,** 22, Campbell Road, Bedford.



# Tested by Ourselves

## A Filament Rheostat

**M**ESSRS. The London Electric Stores, Ltd., who are sole agents for the C.E. Precision Rheostats and Potentiometers, have submitted a sample rheostat for test purposes.

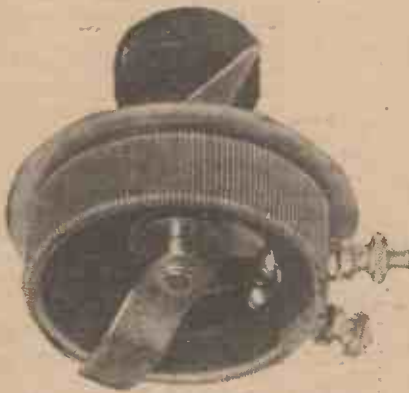

The C.E. Precision filament rheostat.

### Description of Component

The resistance element is wound on a hard fibre strip  $\frac{3}{8}$  in. wide and bent into a circular form  $1\frac{1}{2}$  ins. in diameter. This is mounted on a special moulded cylinder, which supports the bush for the moving contact arm. Single hole fixing is provided for, a milled insulating knob and a metal pointer being fixed at the top of the centre spindle. A metal plate is incorporated, marked with divisions from 0 to 10, which is fixed on the panel by the nut holding the component in position. Two small terminals make connection to one end of the resistance wire and the moving contact arm.

### Laboratory Tests

The resistance was rated at 15 ohms, and on measurement the value was found to be 14.3 ohms. When incorporated in a Radio Press receiving set the movement was quite smooth and the motion of the contact arm

could barely be detected from sounds in the telephones. The rheostat carried a current of 0.6 amp. without undue heating.

### General Remarks

This rheostat is well made, but might with advantage be provided with soldering tags.

## Reco H.T. Battery

**T**HE Radio Equipment Co., Ltd., have submitted two sample 60-volt "Reco" H.T. units for test at our Elstree Laboratories.

### Makers' Claims

The H.T. battery can be recharged, the charging current not to exceed 0.1 ampere. After use for a short period the battery will recover some of its voltage if left standing for a time. The electrolyte does not contain any acid, is free from poison, and can be used without detriment to hands and clothes.

### Description of Apparatus

The forty small cells are contained in a black wooden box 9 ins. by 6 ins. by  $3\frac{1}{4}$  ins., with a detachable lid. The cell containers are 2 ins. high and 1 in. in diameter, and are covered with white enamel, together with the terminals and series connectors. Tappings are taken to seven metal sockets arranged in the side of the box, with labelled values of 15, 24, 33, 42, 51 and 60 volts. Full instructions for preparing the cells for use are given on the underside of the detachable lid.

### Laboratory Tests

The solution was added to each unit and the voltage was found to be 60 volts. For 48 hours a leak of 100,000

ohms was placed across the terminals of each battery and the voltage registered at the end of this period was 55 volts. The batteries were then employed in our Test Department for use while testing wireless receiving sets, the voltages being taken every morning. The voltage dropped to 51 volts after five days, and then recovered slightly after 48 hours' rest, after which the battery voltages fell to 48 volts at the end of a further two days' use. The average daily employment for these units was at least six hours. The electrolyte was found to evaporate slightly, but it sufficed only to add boiled water which had been left to cool, as recommended by the makers.

The units were recharged according to makers' instructions, and were found to work quite well again. They have a capacity of at least 500 milli-



This Reco H.T. battery is rechargeable and does not employ acid as an electrolyte.

ampere hours when the voltage is reduced from 60 to 48 volts.

### General Remarks

These H.T. units should prove very useful accessories, as they work exceedingly well and can be recom-

# Quality RADIO

PRICES ARE REDUCED

THE increased demand for Quality Components has enabled us to make material reductions in prices. Write to us or ask your dealer for our new catalogue.

## Cam-operated Vernier Coil Holder



Now 5/6

Postage 4d.

Ensure dead accurate tuning with this coil holder. The usual fixed socket is controlled by a cam operated by a separate knob. This permits of vernier control through 10 degrees in both directions. The holder which really gives both coarse and fine tuning.

## Back of Panel Valve Holder



Now 1/6

Postage 2d.

The most suitable holder for use behind vertical panels in the popular American type of set. The plate socket is fitted with our patent insulating bush which is an effective insurance against accidental shorting of the valve across the H.T.

BRITISH—from start to finish  
**Goswell Engineering Company, Limited**  
 95/98 White Lion St., London  
 Telephone: North 3051. N.1

mended with confidence. No extraneous noises attributable to the batteries were found when employing them on set testing, and the absence of any dangerous chemicals or acid in the electrolyte is a feature worthy of note.

### Rheostats

MESSRS. The Edison Swan Electric Co., Ltd. have submitted to us for test samples of their rheostats, namely, a dual rheostat and a dull emitter rheostat rated at the resistance of 30 ohms.

#### Makers' Claims

For the dual rheostat novelty is claimed for the method of changing over from the high resistance to the low resistance side of the rheostat. A special point is made of the phosphor bronze coil spring which is used, and this is of considerable mechanical strength and resilience to ensure that the frequent motion of the contact arm does not spoil electrical contact with the resistance wire. For the dull emitter rheostat the virtue of compactness is claimed, this being obtained by winding the resistance wire around a fibre strip bent to the form of a cylinder.

#### Description of Components

The resistance elements of both these rheostats are wound on insulating formers bent into a circular shape. The method of varying these resistances is the same for both rheostats, consisting of a contact arm which can be revolved



A dual filament resistance made by the Edison Swan Electric Co., Ltd.

by means of a knob of moulded material. Terminals are provided in both cases, but no soldering tags. In the dual rheostat the contact arm can be changed from one resistance element to the other by pressing the knob of the rheostat, which enables the contact arm to clear a stop. A dial of pleasing appearance is also provided for the

dual rheostat, and is marked "bright emitter valves," "dull emitter valves," and "off" to indicate the different positions.

#### Laboratory Tests

It was found on test that the resistance of the dull emitter rheostat was 33 ohms, while the resistances of the two parts of

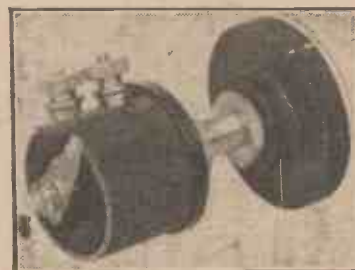

This compact wire filament rheostat is for dull emitter valves.

the dual rheostat were, respectively, 7.5 ohms and 37 ohms. For the dull emitter rheostat and the dull emitter part of the dual rheostat 0.2 ampere could be passed without undue heating, while for that part of the resistance element of the dual rheostat intended for bright emitters 0.7 ampere was as much as could be passed without very considerable heating. It was found that the motion was quite smooth and noiseless.

#### General Remarks

These rheostats are well made and well finished, and can be recommended.

### Pelican Receiving Set

A NOVEL portable four-valve receiving set has been sent to us for test by Peel Cahill & Co., Ltd.

#### Makers' Claims

This set has been primarily designed to provide an instrument for receiving at least two stations in all parts of England, viz., the local station and Daventry. Provision is made for outside aerial and earth connections, while panel controls have been reduced to a bare minimum.

#### Description of Set

The set complete with batteries, frame aerial and loud-speaker is contained in a well-finished wooden cabinet about 17 ins. by 16 ins. by 9 ins., with a leather handle at the top for carrying purposes. Double doors are opened for access to the control panel, which has mounted on it a vernier dial tuning condenser

*"That LEWCOS Coil  
makes all the difference!"*



*In the LEWCOS  
Coil the makers  
of "Glazite" have  
achieved another  
outstanding  
success.*

**T**HIS wireless enthusiast knew that when he found a coil marked LEWCOS it was sure to be better. Coil after coil had been tried and discarded in an endeavour to realise that rare selectivity and fine tuning so essential to complete radio enjoyment.

A LEWCOS coil will make all the difference to *your* set. Try one and prove for yourself.

Each LEWCOS Coil is tested in our laboratory. It is then boxed and sealed up, and reaches you in perfect condition. Ask your radio dealer for a demonstration.

*You'll notice the difference with a*

**LEWCOS**

*Inductance Coil!*

**THE LONDON ELECTRIC WIRE CO., & SMITHS Ltd.,**

*(Makers of Electric Wire for over 40 years.)*

**PLAYHOUSE YARD, GOLDEN LANE, LONDON, E.C.1**



*Why*

**LEWCOS COILS**

*give better tuning.*

1. The LEWCOS Coil embodies high electrical efficiency with great mechanical strength.
2. The LEWCOS Coil is very selective, resulting in extremely fine tuning.
3. The LEWCOS Coil has an exceptionally low high frequency resistance with a corresponding increase in signal strength.

**All LEWCOS Coils  
bear the LEW seal**

*This  
Mark*



*Guarantees  
Quality*

The  
**Varley**  
Constant  
*Wire-wound*  
**Anode**  
**Resistance**



A RESISTANCE wound on the famous Varley Bi-Duplex system, eliminating all inductance between turns.

It is absolutely immune from the effects of heat, damp or any atmospheric change, and therefore perfectly constant in action. The maximum current-carrying capacity is from twelve to fifteen milliamps.

For inter valve coupling where freedom from distortion is the first consideration, use the Varley, Wire Wound and Weatherproof.

**SEE THAT YOU HAVE A VARLEY**  
For Silence, Perfect Tone and Efficiency.

Complete with **7/6**  
Clips and Base

Without Clips and Base 8/-

60,000 ohms, 80,000 ohms, 100,000 ohms.  
Write for Leaflet.



**Constant always**

**The VARLEY MAGNET CO.,**

(Proprietors: Oliver Pell Control, Ltd.)

Woolwich, S.E.18.

Telephones: Woolwich 888, 889.

(Pelican Univernier type), a filament rheostat control, a push-pull valve switch, and a long and short wave change-over switch. Beneath this panel is the loud-speaker opening. On closing the doors the valve switch is automatically brought into operation, cutting off the accumulator supply to the valves. A side door can be opened for viewing all the components. The loud-speaker, which is of the high resistance, portable type, manufactured by A. Graham & Co., is situated in the bottom half of the cabinet with the H.T. and L.T. batteries. A horizontal shelf is employed to support all the other accessories in the top half of the cabinet.

The set itself consists of one H.F., one detector, and two L.F. valves. The eight pole double throw-over switch is used in one position to put three aerial loop circuits in parallel and a low wavelength transformer between the first and second valves, and in the other position the three aerial loop circuits are in series and a high wavelength transformer is connected between the first and second valves. The aerial is located in one of the cabinet sides, and consists of a number of spiral turns of three parallel wires wound on a length of insulating strip, each turn being well spaced. Dull emitter valves are employed in anti-microphonic holders, and a 30 ampere hour accumulator of the non-spillable type is used for the L.T. source.

**Laboratory Tests**

The set was tried at our laboratories 13 miles from 2LO and about 60 miles from 5XX. Both stations were received at full loud-speaker strength, and the sharpness of the tuning made the vernier dial of the condenser a necessity. Capacity reaction is accomplished by the aid of a small adjustable condenser inside the cabinet. The frame aerial was very efficient, and good directional effects were obtained by rotating the whole cabinet.

Oscillation is also controlled by adjusting the filament rheostat, but when tried on an outside aerial, this control made the set difficult to handle. Birmingham, Newcastle and Radio Paris were, however, heard on the loud-speaker in this case.

**General Remarks**

The set fully justifies the makers' claims inasmuch as it is an efficient two station portable receiver. It is rather heavy to carry, as the complete weight is about 30 lb. The oscillation con-

trol from the filament rheostat may be improved by using a fine vernier to prevent it being so critical. Other combinations of valves were tried, but it was found that the best is that recommended by the makers, i.e., two D.E.2 (M.O.) valves for the first two stages and two S.P.18 (Cosmos) valves in the L.F. amplifying stages.

The convenience of having every accessory contained in one cabinet is a feature which will commend itself to many people. The quality of the reproduction in the loud-speaker was not considered good, but it is difficult to expect a complete self-contained receiving set of this type and size to be absolutely efficient from every standpoint.

**Three-way Coil Holder**

**M**ESSRS. F. Guiterman & Co., Ltd., have submitted to us for test a sample of their "Etherac" vernier three-way coil holder.

**Manufacturers' Claim**

It is claimed that the fine adjustment provided allows of exceptionally close tuning without inter-

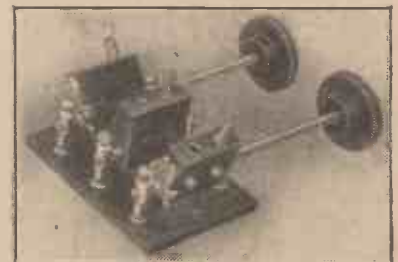

This three-way coil holder has a special slow-motion control.

fering in any way with the coarse adjustment of the coil. It is also claimed that the best non-leak ebonite is used throughout.

**Description of Component**

This coil holder is mounted on a piece of ebonite about 2½ ins. by 3½ ins. Holes are provided in this so that it can be screwed to the side of a cabinet or in any other position desired. The metal parts of this coil holder are all of brass, while brass screws and washers on the side of the different coil holders are provided so that the necessary connections can be made. Both the moving coil holders are mounted on a brass shaft about 3½ ins. long, terminating in milled knobs of convenient size. The coil holders are mounted eccentrically on their



**B.500. INTERVAL TRANSFORMER** guaranteed for 12 months. Price 21/- each. This Transformer has been adopted by leading manufacturers of wireless receiving sets and discriminating amateurs in all parts of the world. Excellent results have been obtained on tests carried out by the National Physical Laboratory. Copy of the curve can be had on application.

# Silvertown

## on a Wireless Component-Means



**B.558. VARIABLE CONDENSERS** For use as Independent Units. Strongly constructed on the same principle as variable condensers for panel mounting. Enclosed in dust-proof non-inflammable Celastoid covers, and fitted with dial, knob, two terminals and three feet for fixing to table or board if required.

Price 12/- each.



**SILVERTOWN POTENTIOMETERS.** On rectangular ebonite former, complete with knob and pointer. Former mounted on cast brass frame. Resistance approximately 400 ohms.

**New Reduced Prices.**

**B.529.** For panel mounting, 5/-; old price, 7/6.  
**B.564.** Mounted, 15/6; old price, 18/-

an assurance of the finest quality obtainable. For over 50 years The Silvertown Company have been manufacturing Electrical Apparatus, during which time they have gained an unassail-

able reputation for quality accuracy and workmanship in all their products. To say "Silvertown," therefore, when buying wireless accessories, is a safeguard to you in ensuring

# Perfect Reception

Makers:

## THE SILVERTOWN COMPANY

106, Cannon Street, London, E.C.4.

Works: Silvertown, E.16

BELFAST: 75, Ann Street.  
BIRMINGHAM: 15, Martineau St.  
BRISTOL: 4, Victoria Street.  
CARDIFF: Pier Head Chambers, Bute Docks.

DUBLIN: 70, Middle Abbey Street.  
GLASGOW: 15, Royal Exchange Sq.  
LEEDS: 1, New York Road.  
LIVERPOOL: 54, Castle Street.  
LONDON: 100 and 102, Cannon Street.

MANCHESTER: 16, John Dalton St.  
NEWCASTLE-ON-TYNE: 59 West-gate Court.  
PORTSMOUTH: 49, High Street.  
SHEFFIELD: 88-90, Queen Street.



In replying to Advertisers, use Order Form enclosed.





shaft, so that as the controlling knobs are rotated through the half revolution allowed by stops, they move slightly up and down, thus providing a fine adjustment.

**Laboratory Tests**

It was found on tests that the vernier provided a particularly smooth motion, which, owing to its nature was, of course, free from back-lash, but the coarse motion was just a trifle jerky. The coil holder was found to be a good fit for several makes of coils, and the insulation resistance for each coil holder was infinite.

**General Remarks**

The design of this coil holder is quite good, and its appearance is attractive.

**Valve-holders**

THREE samples of anti-microphonic valve-holders (Types S.P., S.B., and S.F.) have been submitted for test by Messrs. W. H. Tant & Co

*Type S.P.*—This is a valve-holder for "flush" panel mounting. The four valve sockets are mounted on a template so that the holes can be correctly drilled on the panel. The



The three types of valve holders made by Messrs. W. H. Tant & Co.

sockets project about 1/4 in. above the panel, and the metal portion is surrounded by a truncated cone insulator. This insulator rests on a thin disc of rubber, and on the metal socket portions below the panel are rubber cylinders about 1/4 in. long. On screwing into position the screw and washer binds on to the rubber buffer, and thus provides a semi-rigid fixture. The object of the rubber is to reduce microphonic noises, but this purpose appears to be defeated, owing to the fact that the rubber is too hard. On a test for microphonic noises no perceptible difference from an ordinary holder could be noticed. The finish of the component is particularly neat, the anode socket being coloured red, while the other three are black. This will tend to militate against the possibility of inserting a valve incorrectly, although, owing to the sinking of the metal sockets below the surface

# DURABILITY

**ON** the Thames Embankment stand 186 tons of red syenite—a dual memorial to British seamanship and ancient Egypt's innate love of sculpture. The romantic story of Cleopatra's Needle is well-known. How it lay for centuries at Alexandria until shipped to England in 1878. Even then its adventures were not ended. A tempest sprang up and the little ship with its precious burden—but for the skill of the crew—would have foundered. For two thousand years this fine old monument has successfully braved the ravages of Time.

Durability, too, is a special feature of every Eureka Transformer. With its coppered steel case and its hermetically protected contents, a Eureka is fully equipped to resist the ravages of Time. Even moisture—the deadliest enemy that any Transformer has to face—is powerless against the Eureka. It is the last Transformer you ever need buy.

Eureka Concert Grand . . . 25/-	No. 2 . . . 21/-
Baby Grand, Nos. 1 and 2 . . 15/-	Reflex . . . 15/-

# EUREKA

**U.S. Transformers give Unequalled Service**



**SUPER TRANSFORMER**  
 "Modern Wireless" says of the U.S. Super Transformer:

"The present instrument, if the high quality of the specimen submitted is an indication, can be heartily recommended, and indicates the vast strides that have been made recently in the design of really effective transformers for L.F. amplification."

## Fidelity

**J**UST as the master musician interprets with absolute fidelity the creation of a composer, so does the U.S. Super Transformer interpret radio transmissions. Every shade of musical tone colour, stirring overtures, whispering lullabys, is reproduced faithfully and without distortion. U.S. Super reproduction is, in fact, a revelation of what a good transformer is really capable of. It gives unusually high amplification over the whole band of audio frequencies which is consistently maintained throughout the entire range. Know the joy of perfect audio amplification and faithful radio reproduction—Incorporate the U.S. Transformer in your set.

The U.S. Transformer's success lies in the excellence of its design. The core, with no bolts through it, is packed with finest stalloy iron, allowing fullest amplification without hint of distortion; winding is done by experts; terminals are large and comfortable, with ebonite strips at top and soldering tags. Ratios guaranteed 5-1 and 3-1.

**BRITISH MADE.**

### TWO VALVE CABINET SET

**Complete Outfit including—**  
 Set (Two Valve, cabinet as below), High Tension Battery 60 v. Low Tension Battery. Coils (for 300-500 metres). Valves (two Dull Emitter). Standard Loud-speaker. Aerial Equipment. Flex for connecting up.



### THE U.S. RADIO CO., LTD.

Radio Works, Tyrwhitt Road, Brockley, S.E. 4.  
 Phone: Lee Green 2404. Wires: Supertran, Lewis, London.

**PRICE**  
**18/6**  
 From all dealers or direct from the manufacturers.

**PRICE:**  
**£8 : 10 : 0**  
 Including Marconi Royalties. Nothing else required. Nothing else to pay. Absolutely Complete.



### No. 1 W.

Standard Pocket Lamp Size—  
 4½ volt with patent spiral wire terminals and plug sockets to take Wander Plugs.

Note:—1 doz. = 54 volts.

Used units replaced easily.

Connect as illustrated



To connect in Series insert straight Terminal in Spiral of next battery. Bend spiral and thus ensure permanent electrical connection without soldering.

Guaranteed **BRITISH MADE** at our Watford Works. Patent No. 202760.

**PRICE CARRIAGE PAID 7/- PER DOZ., WITH PLUG**



Prices include Wander Plugs Carriage paid.

No. 2W, 16½ volts, 3 volt tappings. Price 3/- Each.  
 No. 4W, 36 " " " " " 6/8  
 No. 5W, 60 " " " " " 12/-  
 No. 6W, 9 volts, Grid, 1½ volts tapping " 2/-

To be obtained from your local dealer or direct from the Works

## BRITISH BATTERY Co., Ltd.

CLARENDON ROAD, WATFORD, HERTS. (Telephone Watford 617)

REGD. TRADE MARK

If you are unable to obtain your favourite *Wireless Journals* from your Newsagent send a :: :: Subscription now. :: ::

Promptly delivered through the post.

### MODERN WIRELESS

Twelve months - 15/- Six months - 7/6

### WIRELESS WEEKLY

Twelve months - 17/4 Six months - 8/8

### THE WIRELESS CONSTRUCTOR

Twelve months - 8/6 Six months - 4/3

### WIRELESS

Twelve months - 13/- Six months - 6/6

### WIRELESS DEALER

(Obtainable by Trade only)

Twelve months (U.K.) 7/6; (Abroad) 10/-

## RADIO PRESS LTD.

(Dept. M) BUSH HOUSE, STRAND, LONDON, W.C.2.

of the truncated cone insulator, it was found impossible to insert a valve wrongly. Soldering tags are provided.

*Type S.B.*—The same features characterise the sockets of this type as in the case of type S.P., but the sockets are mounted on a substantial right-angled bracket composed of hard insulating material. Provision is made in the bracket for one-hole fixing, and the holder is thus readily adjustable to any position.

*Type S.F.*—This holder is of the American type. The base of insulating material is supported on four hemispherical rubber feet, the base being fixed in position by a screw through a centre hole. The sockets, which are shrouded in cylinders of insulating material, project about  $\frac{1}{2}$  in. above the surface of the base, the anode being coloured red as before.

The workmanship and finish of each type are excellent, and the insulation resistance is infinite.

### Two-way Coil Holder

**M**ESSRS. The Norman Radio Co., Ltd., have submitted to us for test a sample of their back-of-panel mounting Two-way Coil Holder.

#### Description of Component

This coil holder is provided with single hole fixing by means of a screwed sleeve and large nut concentric with the main shaft. This shaft is screwed, and is linked to the moving coil holder. A milled knob of moulded material is fixed to the shaft by means of a set-screw, and as this is rotated it causes a screwed sleeve to move along the shaft. This sleeve is linked to the moving coil holder, so that as the knob is rotated a fine motion is imparted to the coil holder. A special feature is the provision of a small terminal for both the moving and fixed coil holders, all of which are fixed relative to the latter. Thus in this coil holder flexible leads are unnecessary.

#### Laboratory Tests

It was found that the motion of this coil holder was particularly smooth, there being no noticeable back-lash. The coil holders were found to provide a good fit for several makes of coils, and the insulation resistance was infinite.

#### General Remarks

This coil holder appears to be in appearance, design and workmanship, a particularly good specimen of its type. It can therefore be thoroughly recommended.



## Only Oldham has the Special Activation Process

**E**XAMINE this new Oldham at your local Wireless shop. Compare its handsome appearance—its air of quality. Note the transparency and stoutness of its celluloid case—its large coloured terminals—its screw-fitting, non-splash vent—its generous sump. And finally compare its plates. Full size, stout, buckle-proof sulphation-resisting plates capable of holding a charge over long periods. But they are not ordinary plates—the process under which they are made and which is capable of astonishing results is an exclusive Oldham feature. You can get it in no other Accumulator. It was

developed over a long period of years during which Oldham accumulators have now a unique reputation for extreme dependability in coal mines.\*

When you choose an Oldham you obtain an Accumulator which for length of life and ability to retain a charge has yet to be equalled. Be sure your next Accumulator is an Oldham—and you'll start saving money in re-charging costs.

\* There are far more Oldham Accumulators in British coal mines to-day than any other make.

Oldham & Son Ltd., Denton, Manchester, & at London & Glasgow

Gilbert Ad. 4579



THE March issue of "The Wireless Constructor," now on sale, marks another step forward in the production of sets for home constructors.

The special feature of this issue is *The "Huntsman" Two* by Percy W. Harris, M.I.R.E., "A sensitive non-radiating two valve receiver for long-range work."

Simple and easily constructed, the circuit comprises a stage of H.F. amplification followed by a detector valve. As its name suggests, this receiver can be used for "hunting" stations, and made to oscillate freely without interfering in any way with nearby listeners. Tests have shown that another receiver used in the same room is not affected by persistent oscillation in the "Huntsman."

An article of great interest to all experimenters and home constructors is *Fine Wire Coils* by J. H. Reyner, B.Sc. (Hons.), A.C.G.I., D.I.C., A.M.I.E.E. In this article the author discusses the effects of the gauge of wire employed for winding coils.

**EXTENSION OF FREE BLUE-PRINT SERVICE**

With each past issue of "The Wireless Constructor" the proprietors have presented a free blue-print of one particular set described. In order to help those who desire to build one of the other sets described, a free back-of-panel blue-print of any set in this and future issues of "The Wireless Constructor" will be supplied on receipt of the coupon in that issue.

**The Wireless Constructor**

EDITED BY PERCY W. HARRIS, M.I.R.E.

Obtainable from all Newsagents, Booksellers and Bookstalls, or direct from the Publishers.

Subscription rates, 8/6 per annum;  
4/3 for 6 months.

**Selection from Contents**

*The "Huntsman" Two*  
By Percy W. Harris, M.I.R.E.

*A Useful Selective Three-Valve Receiver*  
By E. J. Marriott.

*The "Two-in-one" Receiver*  
By Philip H. Wood, B.Sc., F.P.S.L.

*The Variometer Tuned Single Valver*  
By G. P. Kendall, B.Sc.

*Fine Wire Coils*  
By J. H. Reyner, B.Sc., A.C.G.I.,  
D.I.C., A.M.I.E.E.

PRICE

**6D**

EVERY MONTH

RADIO PRESS, Ltd., Bush House, Strand, London, W.C.2.

**Brackets**

Messrs. The Formo Co. have submitted samples of brackets to us for test at our Elstree Laboratories.

**Makers' Claims**

It is claimed that these brackets are useful as a method for saving time in building up experimental sets, and represent a considerable advance on the type of bracket hitherto obtainable.

**Description of Component.**

A pair of these brackets placed at the two ends of the panel are designed to support it either vertically or at an angle of 75 degrees to the horizontal. They are made of metal castings of T-shaped section, and are each composed of two parts. One of these is horizontal and is about 6 ins. long by nearly 1/2 in. wide. At each end it bends down and then flattens out to form a foot. One of these, placed at either end of the baseboard, supports it at a height of just over 1 in. from the bench. Screws are provided to fix the brackets to the baseboard. The front foot of each bracket has an almost circular elevation as seen from the side, and a hole is drilled in its centre. Two circular projections from the other part of the bracket fit over this foot, and are pierced with holes to register with this. A nut and bolt secure the two parts of the bracket together and permit rotation, which is, however, limited to the necessary 15 degrees by stops. The second part of the bracket can be fixed to the panel by screws. The horizontal part of the bracket is also provided with holes for fixing to the side of the cabinet when the set is completed.

**Laboratory Tests**

The brackets supplied were found very convenient for experimental sets in which an ebonite baseboard was used. The casting was quite strong enough for the purpose for which it was designed, but care should be taken to avoid subjecting the brackets to any unnecessary strain.

Amateurs should find these brackets exceedingly useful for experimental work. Longer screws for the baseboard would enable thick wooden baseboards to be employed when desired, but we understand that these are now being supplied by the firm. By having the baseboard clear of the bench or table, through the agency of the supporting feet, it is possible to conceal some of the wiring of the set when desired.

**CLEARTRON CHARACTERISTICS**

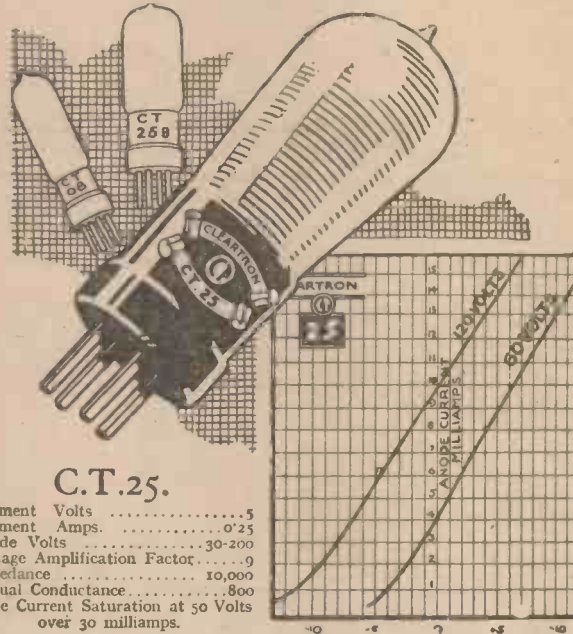

**C.T.25.**  
 Filament Volts ..... 5  
 Filament Amps ..... 0.25  
 Anode Volts ..... 30-200  
 Voltage Amplification Factor ..... 9  
 Impedance ..... 10,000  
 Mutual Conductance ..... 800  
 Plate Current Saturation at 50 Volts  
 over 30 millamps.

**H**ERE we show you the electrical characteristics of the CLEARTRON Dull Emitter C.T.25; we could talk to you for hours about its general excellence. But charts and talk cannot convince like an actual trial. Give it a "try out" and prove by your experience that CLEARTRON valves in your set mean vastly increased volume and greater distance; operatic purity, keener selectivity and longer life. And unless the C.T.25 produces all these claims and all these advantages it will be replaced without cost or question—our IRONCLAD GUARANTEE sees to this.

Send for illustrated Catalogue post free.

Type	Accumulator or Battery volts	Fil.volts.	Fil. amp.	Purpose	Price
C.T.08.	Dry cells	3	0.08	H.F., L.F. Detector	12/6
C.T.15.	2 volt Accumulator	1.8	0.15	H.F., L.F. Detector	12/6
C.T.25.	6 volt Accumulator	5	0.25	H.F., L.F. Detector	15/-
C.T.25.B.	6 volt Accumulator	5	0.25	General purpose resistance coupled amplification	15/-

America's foremost valve made in Britain's newest factory.

**CLEARTRON RADIO LIMITED**

1, CHARING CROSS, LONDON, and BIRMINGHAM.

Phone: Regent 2231/2.

Grams: Cleartron, Westrand, London.

British Made





2<sup>D</sup>  
EVERY TUESDAY

**"Wireless"—the One-Word Weekly** is read by all who acknowledge Wireless their hobby.

The topical news features will prove of great interest to you and its articles of immeasurable assistance. The result of careful experiment and exhaustive research, the circuits published in its pages are guaranteed to fulfil the claims of the authors. The contents of "WIRELESS" may be taken as the definite and considered opinion of experts.

Every article and viewpoint expressed is worthy of your perusal and consideration, helping you in the pursuit and extension of your hobby.

Obtainable from all Newsagents and Booksellers or direct from the Publishers.

*"WIRELESS" is the only 2d. technical paper available.*

Subscription rates: 13/- per annum. 6/6 for six months.

**WIRELESS**  
THE ONE WORD WEEKLY 2<sup>D</sup>

Published every Tuesday by  
RADIO PRESS, LTD., Bush House, Strand, W.C.2

**A SET FOR  
VALVE RECTIFICATION  
EXPERIMENTS**

(Concluded from page 728)

with the two methods were nearly equal. It was also noticeable that "parasitic" noises incidental to the operation of the valve were reduced, partly no doubt because the filament was run at a lower temperature with anode current than with cumulative grid rectification.

**Another Experiment**

A further experiment which may be tried with this set is the effect of a combination of the cumulative grid method of rectification with the use of the potentiometer. By keeping both the grid condenser and leak and the potentiometer in circuit together, the effect of applying various potentials to the grid may be tried. It may be found, especially with some types of dull emitter valves, that a more efficient working grid potential can be applied than that provided by the normal connection of the leak to the positive terminal of the filament battery.

**A Precaution**

It should be noted that when the grid battery is in use it must be carefully insulated from earth. When the battery is included in circuit in the position described above, it is at H.F. potential above earth, and leakages from it to earth may cause a considerable decrease in the efficiency of the circuit, thus destroying the value of comparative tests. The battery may be insulated by placing it on a spare piece of ebonite or in any other convenient way. It may also be found advantageous to shunt its terminals with a by-pass condenser, for which .002  $\mu$ F should prove a suitable capacity.



Crystal gazing up-to-date. Experiments being conducted at Birmingham on a new oscillating crystal.

**A Reader's Experience with the  
"Family Four" Receiver**

SIR,—I thought it might interest you if I forwarded the results I have obtained with the "Family Four," described in Radio Press Envelope No. 2. My aerial is not really a bad one, although screened by two bigger and higher aerials, 10-15 feet on either side. Receiving so many stations I decided to log them, and appended are a number received from December 19, 1925: Oslo, London, Manchester, Munster, Toulouse, Hamburg, Madrid, Radio Wien Berlin, Radio Paris, Petit Parisien, Leeds-Bradford, Nottingham, Daventry, Birmingham, San Sebastian, Sheffield, Stoke-on-Trent, Malmo, Paris (Eiffel Tower), Newcastle, Hilversum, Hull, and Aberdeen. I have many more stations to the set's credit, but have not logged them. I have now dismantled the set and constructed another of Mr. Percy W. Harris's sets, the "Harmony Four." I have great hopes for this set, but have not got quite used to it. Perhaps you will wonder why I have not tried to receive America,

but I am an invalid and have been unable to sit up for the transmissions. Being in bed by no means deters me from being an enthusiast however, and I have a pile of MODERN WIRELESS, *Wireless Constructor* and other Radio Press publications from which I derive a great pleasure. In addition to the other sets, I have made the 4-valve T.A.T. from which about three times the number of Continental and English stations have been received, the short wire panel and tuner (*Wireless Constructor*), the twin valve, the half-hour crystal receiver (*Wireless*), and numerous other Radio Press sets, all, of course, being O.K., and only my desire for experimenting has made me pull these to pieces. I have not written this great epistle for taking up the valuable space in MODERN WIRELESS, but just to thank the staff of Radio Press for their topping sets. Wishing all your publications the success they deserve.—Yours truly,  
*Sheffield.* W. F. JACKSON.

**"Wireless"**  
THE ONE-WORD  
WEEKLY



Published Every Tuesday

PRICE 2d.

3<sup>D.</sup>

3<sup>D.</sup>



The Editor :  
JOHN SCOTT-TAGGART,  
F.Inst.P., A.M.I.E.E.

Buy the New  
**WIRELESS  
WEEKLY**  
Now only **3<sup>D.</sup>**

LONG recognised as the leading technical weekly, this paper is now within the reach of all. Its contents at the new price remain the same in quantity, but the scope has been extended to appeal to a much wider public.

In addition to articles from the Editor, John Scott-Taggart, F.Inst.P., A.M.I.E.E., and the Technical Editor, J. H. Reyner, B.Sc.(Hons.), A.C.G.I., D.I.C., A.M.I.E.E., two very important contracts for articles have been signed by Capt. H. J. Round, M.I.E.E., Chief of the Research Dept. of the Marconi Company and by Capt. A. G. West, the Chief Research Engineer of the B.B.C. These contracts cover a year and six months, respectively, and will ensure frequent and regular articles from these experts.

No. 1, published Feb. 17th, was the first of a new volume. If you are unable to obtain the two back numbers necessary to complete the volume through your usual channel, apply direct to the publisher.

The new Wireless Weekly has proved an immense success. To be sure of getting your copy every week place a regular order with your newsagent or book-stall NOW or send a Subscription direct to Dept. M., Radio Press, Ltd., Bush House, Strand, London, W.C.2.  
Subscription Rates : 17/4 per annum ; 8/8 6 months.



Technical Editor :  
J. H. REYNER, B.Sc. (Hons.),  
A.C.G.I., D.I.C., A.M.I.E.E.

**Wireless  
Weekly**

**RADIO PRESS LTD.,**  
BUSH HOUSE, STRAND, LONDON, W.C.2.

3<sup>D.</sup>

3<sup>D.</sup>



**GET TO KNOW**  
**Pickett Brothers**  
 for Radio  
**CABINETS**



As actual makers of Cabinets we can offer an unrivalled selection of De Luxe and Parlour Models. Prices from 1/6 to 25 from stock or made to order in 7 days, and expertly constructed to your own specification. Illustrated List and Estimates post free. Panels for any cabinet and complete accessories can be supplied. 100-page Accessory List 3d.

**PICKETT BROS. (Members B.E.C.)**  
 M.W. CABINET WORKS,  
 BEXLEY HEATH  
 (Nr. London.)

*Howell Repairs*

**REPAIRS** SETS  
 'PHONES TRANSFORMERS

Officially approved by Radio Association  
 All work guaranteed. Lowest rates  
 24 Hour Service.

**J. W. MILLER, 68, Farringdon St., E.C.4.**  
 'Phone: Central 1950.

**MAP**  
 Small Parts to the Trade.



**M.A.P. Co., 246, Gt. Lister St., Birmingham.**

**A WIRELESS "DOCTOR"**  
 If your set is giving trouble or you want advice, an expert will call, anywhere in Greater London, and put you right. No result, no charge.  
**BLACK, 2a, Woodville Grove, N.16. Clissold 3687.**

All communications regarding advertising in

**"MODERN WIRELESS"**

should be addressed to—  
 Advertisement Manager,  
 "MODERN WIRELESS,"  
 Bush House,  
 Strand, London, W.C.2.

**COUPON.**

**QUESTIONS & ANSWERS**

In future this coupon must be accompanied by a P.O. for 2/6 for each question and a stamped addressed envelope.

**"MODERN WIRELESS"**  
 March, 1926.

Working with Two Valves and a Crystal.—(Concluded from page 718).

longer waves a higher tapping on the H.F. choke should, of course, be tried.

Should it be desired to use direct coupling in both of the tuned circuits by connecting the aerial lead to the point X and the anode lead to point Y (Fig. 1), then for L<sub>1</sub> a No. 35 or 50 for the lower broadcast band, and a No. 150 or 200 for 5XX will be found suitable in most cases. For L<sub>2</sub> the numbers already indicated above will be found correct.

**Valves**

Regarding the valves to be used, it is mentioned that two of the general purpose type will be found suitable. Whilst this is quite correct, better results, of course, may be expected if the valves used are made specially to function in their various positions.

A D.E.5b. as V<sub>1</sub> and a D.E.5 as V<sub>2</sub>, the H.T. voltages being about 70 for V<sub>1</sub> and 120 for V<sub>2</sub>, with 6 volts grid bias, were found to give excellent results. The filament current of the D.E.5b. was, however, critical for oscillation to be easily controlled by the potentiometer.

When trying for distant stations, the value of the H.T. on V<sub>2</sub> should not be very high, as it must be remembered that the anode current from V<sub>2</sub> flows through the telephone windings. The potentiometer also, for distant reception, will need to be very carefully adjusted, in order that the H.F. valve may be worked in its most sensitive condition, without self-oscillation taking place.

**Test Report**

Tested on a poor aerial four miles west of 2LO, that station gave exceedingly pure results on an Amplion loud-speaker.

Throughout the test, Lissen "X" coils were used in the tuned grid circuit of V<sub>1</sub>, whilst both "X" coils and the centre tapped variety were tried for L<sub>2</sub>. The former, whilst giving slightly less signal strength, gave a decided improvement in selectivity over that obtained when using the latter type.

Both Bournemouth and Birmingham were heard at fair strength on the telephones, but in the case of 6BM, 2LO was still audible in the background.

On the longer waves, 5XX was received at practically the same strength as 2LO on the loud-speaker whilst Radio-Paris gave good loud telephone signals. Tested at the Elstree Laboratories, the above results were confirmed.

**ELECTRADIX RADIOS**

Have opened a large City Showroom at 218, UPPER THAMES STREET, E.C.4. and are selling an enormous stock of Radio and Electrical Goods of the highest grade—Marconi, Siemens, Sullivan, Brown, Western Electric, at bargain prices. Send 4d. for illustrated catalogue and price list. The Stores at 9, Colonial Avenue, Minories, contain tons of goods at sacrifice prices to save removal. Callers only. Telephone: Avenue 4166.

**NEW WESTERN ELECTRIC LOUD SPEAKERS.**

Complete with Cord in Makers' Sealed Carton,  
 4,000ohms ... 22/6; 2,000ohms ... 20/-  
 70 ohms ... 17/6.

**"THE CATALOGUE THAT SAVES YOU POUNDS."**

Its scope ranges from a 5s. pair of British Headphones or a 12s. 6d. Milliammeter to a 30,000 volt Generator, and covers all requirements.

If you cannot call and inspect goods in our showrooms between 9 a.m. and 6 p.m. it will pay you to send 4d. for our Catalogue at once. Goods promptly despatched all over the world.



**ELECTRADIX RADIOS**

218, Upper Thames Street, London, E.C.4. Phones: City 191.

Address all Post Orders to City Showroom: 218, Upper Thames Street, E.C.4.

**An Ideal Cabinet !**



Yes! A small outlay on a "Morris Standard Cabinet" will keep YOUR receiver DUSTPROOF and FREE from INTERFERENCE. Provision is made for panels up to 30 in. by 18 in. and all accessories are enclosed in this solid oak cabinet in which perfect workmanship is guaranteed.	Solid oak Model. A 22 in. inside £1 15 A 26 in. " 25 6 C 22 1/2 in. " 25 10 C 25 in. " 25 15 C 30 in. " 28 15 Solid Mahogany. A 22 in. " 27 5 25 in. by 18 in. Solid Oak Table £1 7 6 Money returned if not satisfied.
---	--

(Smaller size 56lbs. net). No Plywood used.

Carriage paid and packed free England and Wales.

**MAKERIMPORT CO.** Dept. 2, Nevill Chambers, 50a, Lord St., LIVERPOOL.

**PATENTS, DESIGNS AND TRADE MARKS**

**J. S. Withers & Spooner,**  
 Chartered Patent Agents.

Staple House,  
 51 & 52 Chancery Lane,  
 London, W.C.

Tel. "Improvably,"  
 Holb. London,  
 Tel. 480 Holborn



**100% EFFICIENCY H.T. BATTERY**

See editorial report, April issue, also Experimental Wireless, June. Giant Unit Dry Cells, 14 volts. Compare standard cell on block. 4/- doz. slide carriage. 60 volt box type, 19/6, carriage 1/9. Direct from maker only, saving 50 per cent.; full details free. Sample cell, 6d.

**FINCHETT (C. A.), OLD ARMOURY, OSWESTRY**

Index to Advertisers

	PAGE		PAGE		PAGE
"A. J. S." .. .. .	777	Electradix Radio Stores .. .. .	815	Naylor (J. H.), Ltd. .. .. .	790
American Hard Rubber Co., Ltd. ..	770	Electron Co., Ltd. .. .. .	794	Neutron, Ltd. .. .. .	770
Artcraft Co., The .. .. .	796	Engineering Works, Ltd. .. .. .	778	Norman Radio, Ltd. .. .. .	762
Ashley Wireless Telephone Co. ..	784				
Athol Engineering Co. .. .. .	798	Fada Radio, Ltd. .. .. .	750	Oldham Accumulators .. .. .	809
Autoveyors, Ltd. .. .. .	758	Ferranti, Ltd. .. .. .	766	Ormond Engineering Co., Ltd. ..	780
		Finchett, C. A. .. .. .	815		
Beard and Fitch .. .. .	787	Formo Co .. .. .	796, 798	Peto and Radford .. .. .	758
Bedford Electrical Co. .. .. .	800			Peto-Scott Co., Ltd. .. .. .	791
Benjamin Electric, Ltd. .. .. .	791	Garnett, Whiteley and Co., Ltd. ..	786, 796	Picketts .. .. .	815
British Battery Co., Ltd. (The) ..	803	Gent and Co., Ltd. .. .. .	794	Portable Utilities Co., Ltd. ..	797, 807
Bird (Sydney S.) .. .. .	770	Goswell Engineering Co., Ltd. ..	802	Power Equipment Co., Ltd. ..	753
Black (A.) .. .. .	815	Graham (A.) and Co. .. .. .	773		
Bowyer-Lowe Co. .. .. .	816	Heayberd, F. C. and Co. .. .. .	790	Radio Communication Co., Ltd. ..	674
Brandes, Ltd. .. .. .	746	H.T.C. Electrical Co., Ltd. ..	774	Radio Instruments, Ltd. ..	Cover iv
Bretwood, Ltd. .. .. .	799	Hunt (A. H.), Ltd. .. .. .	766, 786	Reflex Radio Co., Ltd. .. .. .	790
British Thomson-Houston Co., Ltd.	778			Rothermel Radio Corporation of	
Brown Brothers, Ltd. .. .. .	753	Igranic Electric Co., Ltd. .. .. .	769	Great Britain, Ltd. .. .. .	797
Brown (S. G.), Ltd. .. .. .	761	Jackson Bros. .. .. .	778		
Burne-Jones and Co., Ltd. .. .. .	800			"S. A. Cutters," Ltd. .. .. .	799
		Lissen, Ltd. .. .. .	745	"Sel-Ezi" Wireless Supply Co., Ltd.	794
Cahill and Co., Ltd. .. .. .	800	London Electric Wire Co. .. .. .	803	Silvertown Co. .. .. .	805
Carrington Mfg. Co., Ltd. .. .. .	798			Simpson and Blythe .. .. .	799
Caxton Wood Turnery Co. .. .. .	762	McMichael (L.), Ltd. .. .. .	754, 783	Stevens (A. J.) and Co. (1914), Ltd.	777
Clackson (A. H.), Ltd. .. .. .	774	Makerimport Co. .. .. .	815	Telegraph Condenser Co., Ltd. ..	733
Cleartron Radio, Ltd. .. .. .	811	M. and A. W. .. .. .	780	U.S. Radio Co., Ltd. .. .. .	803
Collinson Precision Screw Co., Ltd.	787	Marconiphone Co., Ltd. (The) ..	749	Varley Magnet Co. .. .. .	804
Cosser (A. C.), Ltd. .. .. .	792, 793	Metro-Viek Supplies, Ltd. ..	757, 762, 766		
Curtis (Peter), Ltd. .. .. .	784	M.A.P. Co. .. .. .	815	Wates, Bros., Ltd. .. .. .	772
		Miller, J. W. .. .. .	815	Wilder, Devlin and Co. .. .. .	790
Dubilier Condenser Co. (1925), Ltd.	758, 765	Moore, H. .. .. .	798	Wilkins and Wright, Ltd. .. .. .	774
		Mullard Radio Valve Co., Ltd. ..	Cover ii	Withers and Spooner .. .. .	815
Edison Swan Elect. Co., Ltd. .. ..	789				

There's a Bowyer-Lowe Condenser for every Job

From the Bowyer-Lowe series of condensers you can always choose one exactly suitable to the set you are making or the experiment you are conducting, and in every case you know that the instrument you buy reaches the highest standard of

tuning efficiency. You may prove this without risk, because every Bowyer-Lowe Condenser will be exchanged if it proves in any way unsatisfactory within twelve months of purchase.

"STANDARD" FOR PRECISION.

Made in single, double and triple types and in all useful ranges, these Condensers are unequalled for wavelength range because their capacity ratios are the highest yet attained. You will notice an improvement in signal quality as soon as you instal a "Standard" Condenser in any set you have built. Prices from 11/6.

BOWYER-LOWE "STANDARD" CONDENSER.

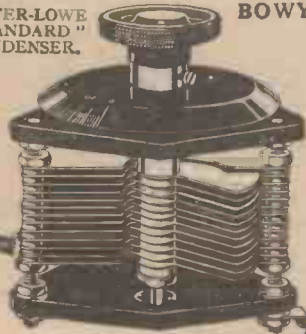

"FOUR-SQUARE" FOR EXPERIMENTS.

Use this condenser if you go in for experimental work demanding instruments of the highest precision. Each condenser has four alternative capacities, balanced vanes on ball-bearing spindle, and optional 33 to 1 geared vernier. There are models at 28/- and 30/-, Vernier for either model 5/-.

BOWYER-LOWE CO., LTD., LETCHWORTH. BOWYER-LOWE "FOUR-SQUARE" CONDENSER.

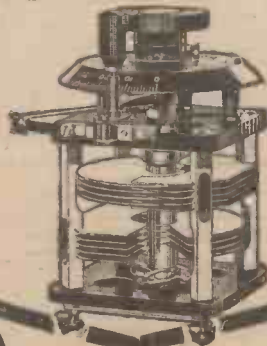

"POPULAR" FOR ALL-ROUND EFFICIENCY AT A LOW PRICE.

Priced at 10/- and 10/6 respectively, the .0003 and .0005 "POPULAR" Condensers represent the highest standard of construction possible at such a price. Ball-bearing control, square-law tuning, low loss design. Test the "POPULAR" and you will always use it.

BOWYER-LOWE "POPULAR" CONDENSER.

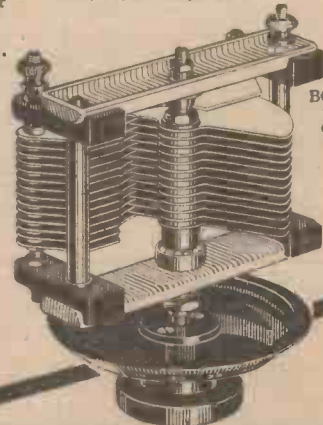

BOWYER-LOWE TESTED CONDENSERS

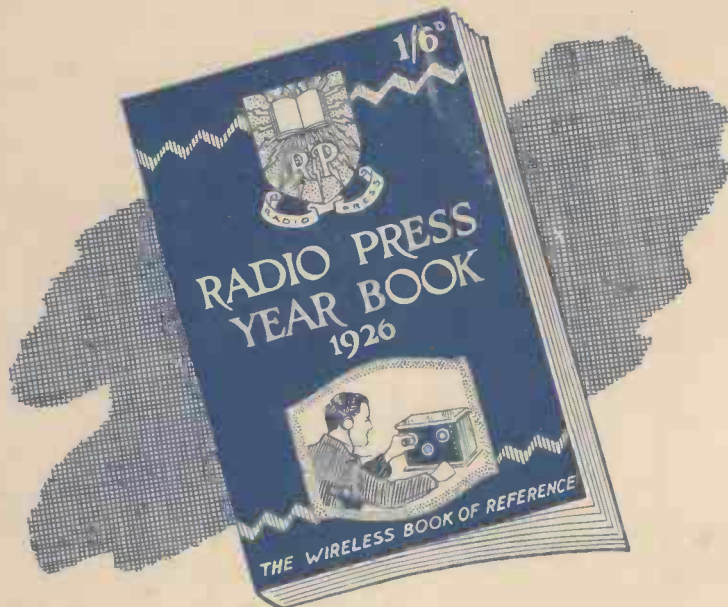

Joint Editors { John Scott-Taggart, F.Inst.P., A.M.I.E.E.  
Percy W. Harris, M.I.R.E.

## Facts at the Finger-tips.

*The Radio Press Year Book—an indispensable reference book for the wireless constructor and experimenter—is now available for the small sum of 1/6. The brief summary given below provides only a slight idea of the great value of this book to all Modern Wireless readers.*

### SPECIAL ARTICLES BY EXPERTS.

**Listening to America.** By Capt. A. G. D. WEST, M.A., B.Sc., known to all as the B.B.C. engineer in charge of the reception and relaying of American broadcast. **Some Facts About Valve Filaments.** By Capt. H. L. CROWTHER, M.Sc.

**Getting the Best from Your Aerial.** By Capt. JACK FROST, of the B.B.C.

Is your aerial as efficient as it can possibly be? This article will give you numerous hints on its erection, insulation, and other practical matters. **Low-Frequency Magnification.** By Capt. H. J. ROUND, M.C., M.I.E.E.

The name of Captain Round, of the Marconi Company is familiar to all, and articles emanating from his pen are at once authoritative and practical. This combined technical and practical knowledge is compressed into a brief talk on this important phase of Radio Reception. **Controlling Oscillation in H.F. Amplifiers.** By Major JAMES ROBINSON, D.Sc., Ph.D., F.Inst.P.

The causes and effects of oscillation in the H.F. stages give experimenters much thought and worry. Careful study of the facts set out here will help you to solve these problems.

**What is Coil Resistance?** By J. H. REYNER, B.Sc. (Hons.), A.C.G.I., D.I.C., A.M.I.E.E.

Discussing the best size of wire to use for your tuning coils, this article gives much additional information hitherto very difficult of access to the ordinary reader.

### SPECIAL DATA.

#### Valve Section.

Full particulars of all the leading types of valves are given in this section. Their working characteristics are given in detail, and the respective makers' curves are included for the first time between two covers.

#### Call Signs.

We have here collated the most up-to-date and comprehensive list of Amateur stations yet published, and a quantity of useful miscellaneous information in the most practical form for ready reference.

#### Wireless Calculations Made Easy.

This section places at the disposal of all the few calculations which may be considered essential to the proper enjoyment of wireless as a hobby.

#### Workshop Section.

Soldering, wiring, drilling—in fact, every operation in the construction of a receiver is described in this section. In addition, much useful data on drill sizes, wire tables, etc., is included.

Obtainable from all Newsagents, Booksellers and Bookstalls or direct from Dept. M, Radio Press Ltd., Bush House, Strand, London, W.C.2.

# RADIO PRESS LTD.

BUSH HOUSE, STRAND, LONDON, W.C.2.

# For every valve — for every circuit

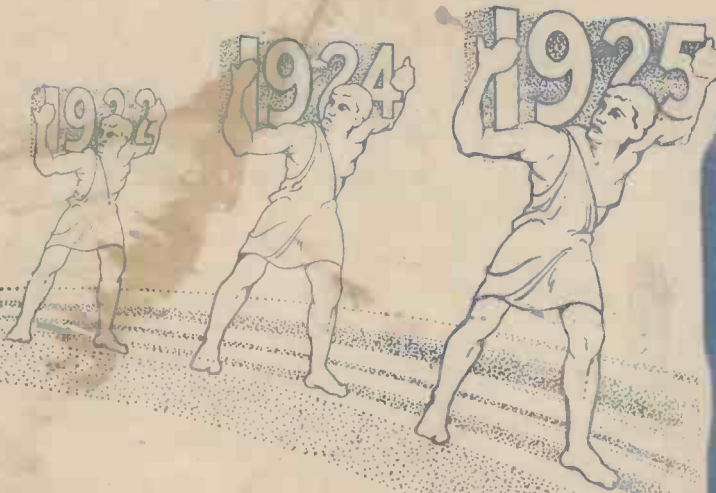

## A Multi-Ratio Transformer

7 RATIOS

# 1926

FOR many years wireless research has been slowly evolving the perfect transformer. Much intensive experimental work, many years of apparently fruitless endeavour, have been decidedly leading to the ultimate goal; and it has fallen to R.I., Ltd., with their "infinite capacity for taking pains," to produce that transformer.

R.I. are now able to market a multi-ratio transformer which, while still retaining all the features of their original model, has a larger number of turns on the primary and secondary, and by tapping certain points and bringing them to a terminal block seven different ratios can be selected as desired. The impedance value covers approximately the wide range of from 6,000 to 60,000 ohms. Thus, whatever the circuit or valve in use, a winding of an impedance suitable for that particular circuit or valve can be chosen at will.

The tapping points of both windings have been selected so as to provide the best ratio for the various circuits and valves at present in use.

In addition to the seven ratios available it is possible to obtain the main one by three alternative methods, allowing a different value of impedance to be selected for the same ratio.

The self-capacity of the transformer is greatly reduced by the patented system of winding the coil, giving a greater degree of amplification on the higher frequencies, up to the useful point of audibility.

This new model is totally encased with a steel shroud. The coil is treated in such a way as to render it suitable for any climate in the world, and the celluloid enamel is practically rust-proof. The terminal block is a bakelite moulding.

A year's guarantee is given with each instrument, and in addition a book of circuits showing the best method of using a transformer as a standard intervalve coupling.

Write now for special booklet M.W.

PRICE 27/6

RATIO TABLE.

Ratio	Approx. Primary Impedance in ohms.
1 — 1	60,000
1½ — 1	28,000
2 — 1	60,000
	7,000
3 — 1	28,000
	60,000
4½ — 1	28,000
6 — 1	7,000
9 — 1	7,000

## THE MARK OF BETTER RADIO

Advt. R.I. Ltd., 12, Hyde St., New Oxford St., London, W.C.1.

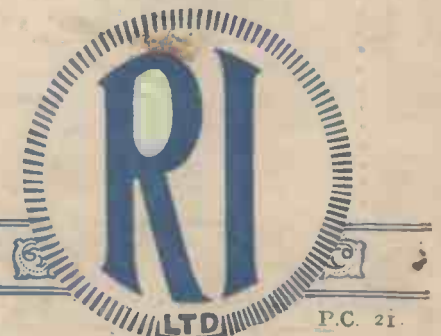

P.C. 21.

Published by the Proprietors, RADIO PRESS LIMITED, Bush House, Strand, London, W.C.2, on the 1st of each month, and printed for them by Messrs. ODHAMS PRESS LIMITED, Long Acre, London, W.C.2.—Address for Subscriptions and Editorial Communications:—Bush House, Strand, London, W.C.2. Address for Advertisements:—Advertisement Manager, "Modern Wireless," Bush House, Strand, W.C.2. Phone: City 9911. Registered as a Magazine for transmission by Canadian Magazine Post. Subscription Rates:—14s. per annum, 7s. 6d. for six months, post free. Sole Agents for Australia: GORDON AND GOTCH (AUSTRALIA), LTD. Sole Agents for South Africa: CENTRAL NEWS AGENCY, LTD.—March 1926.